

SPORT TURBINE KIT INSTALLATION MANUAL



Installation must be done by a professional.
Read this manual prior to the installation.

Always have access to this manual as well as a factory service manual.

※ Make sure the vehicle is applicable to this kit.

NAME OF PRODUCT	SPORT TURBINE KIT
PART NUMBER	11004-AN012
APPLICATION	NISSAN SKYLINE GT-R ①BNR32 ②BCNR33 ③BMR34
ENGINE	RB26DETT
YEAR	①1989/8 – 1994/12 ②1995/1 – 1998/12 ③1999/1 – 2002/8
REMARKS	<p>【NOTE】</p> <ul style="list-style-type: none"> • After installing this product, resetting by a fuel controller such as an HKS F-Con is required due to the engine output increase. • Upgrade the pump, injectors, and/or head gasket if necessary. • Check the spark plugs regularly and replace them if necessary. • Refer to page 2 for the required modifications.

REVISION OF MANUAL

Rev. Number	Date	Manual Number	Details
3-3.01	2016/06	E04211-N48210-00	1 st Edition
3-3.02	2009/07	E04211-N48211-00	Parts List revised.

Published in March, 2017 by HKS Co., Ltd. (Unauthorized reproduction is strictly prohibited.)

NOTICE

This manual assumes that you have and know how to use the tools and equipment necessary to safely perform service operations on your vehicle. This manual assumes that you are familiar with typical automotive systems and basic service and repair procedures. Do not attempt to carry out the operations shown in this manual unless these assumptions are correct. Always have access to a factory repair manual. To avoid injury, follow the safety precautions contained in the factory repair manual.

ATTENTION

- This manual indicates items you need to pay attention to in order to install this product safely and lists precautions to avoid any possible damage and/or accidents.
- This product is an automobile part. Do not use for any other purposes.
- HKS will not be responsible for any damage caused by incorrect installation and/or use, or use after modification and/or dismantling of this product.
- This product was designed based on installation onto a specific factory vehicle.
- The specifications of this product are subject to change without notice.
- The instructions are subject to change without notice. Make sure to refer to the most recent instructions.

SAFETY PRECAUTIONS

The following precautions for use of this product are to prevent possible accidents and/or injuries and for proper use.



WARNING

Indicates risk of serious injury and/or possible death.



































CAUTION

Indicates risk of damage to people or large-scale damage to property.
(Large-scale damage is the damage caused by a product defect.
Ex. Damage to a vehicle, burnout, etc.)

REQUIRED MODIFICATIONS

1. At the time of shipment, the actuator turnbuckle is set to 1-rotation shorter than the length that can be installed to the turnbuckle without pulling the actuator. Make sure the length is the designated length before installing the actuator.
2. The exhaust swing valve of this turbocharger in this kit is enlarged; therefore, this kit cannot be used with HKS Extension Kit (P/N 1418-RN011 • 1418-RN005) because the boost pressure may be uncontrollable.

PARTS LIST

No.	Description	QT	Image	Remarks
1	Turbocharger Assembly	2		GTIII RS
2	Gasket Exhaust	2		
3	Gasket Front Pipe 65mm	2		
4	Gasket Universal Exhaust Sys 75mm	1		
5	Gasket Chamber Pipe	3		
6	Gasket Suction Pipe	2		
7	Gasket Oil Out	2		
8	Rubber Cap 6mm	1		
9	Cu Washer 12mm	6		
10	Cu Washer 14mm	10		
11	Stud Bolt M8	18		
12	Self-Lock M8	8		
13	Oil Inlet Pipe Front	1		
14	Oil Inlet Pipe Rear	1		
15	Plug Block Water Hole	1		Not required in order to install this kit.
16	Plug Water Pipe	2		
17	Bracket Heat Cover	2		
18	Flange Bolt M6	4		L=15mm
19	Oil Outlet Pipe Front	1		
20	Oil Outlet Pipe Rear	1		
21	Oil Inlet Banjo Bolt	2		
22	T-fitting 6mm	1		
23	Tie Wrap (S)	4		
24	Oil Resistant Hose 6mm	1		L=500mm
25	Water Inlet Banjo Pipe	2		
26	Water Feed Tube Eye Bolt	2		
27	Adapter 8mm	2		M14 x 1.5
28	Water Hose 8mm	1		L=780mm
29	Hose Clip	4		#138
30	Insulation Tube	1		L=500mm
31	Installation Manual	1		
32	Instruction Manual	1		

※To purchase individual part, please contact the dealer.

1. REMOVAL OF FACTORY PARTS

Disconnect the negative cable from the battery terminal before installation. Prepare the engine oil and coolant. Use this instruction manual and the manufacturer's service manual as a reference.

1-1. Removal of Under Cover

1-1-1. Removal of Under Cover (BNR32)

- (1) Remove 13 screws (Reuse), and remove the under cover. (Dia.1-1-1)

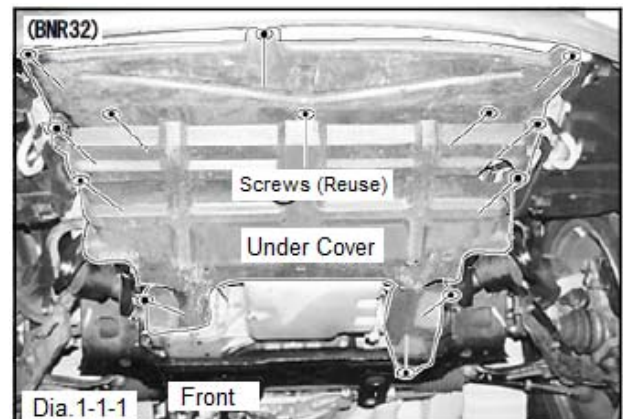

1-1-2. Removal of Under Cover (BCNR33 & BNR34 Std.)

- (1) Remove 10 screws (Reuse), and remove the under cover. (Dia.1-1-2)

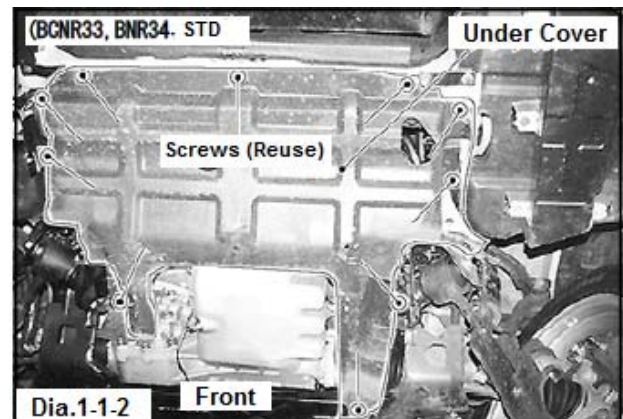

1-1-3. Removal of Front Diffuser (BNR34 V-spec.)

- (1) Remove 17 bolts (Reuse), and remove the front diffuser. (Dia.1-1-3)

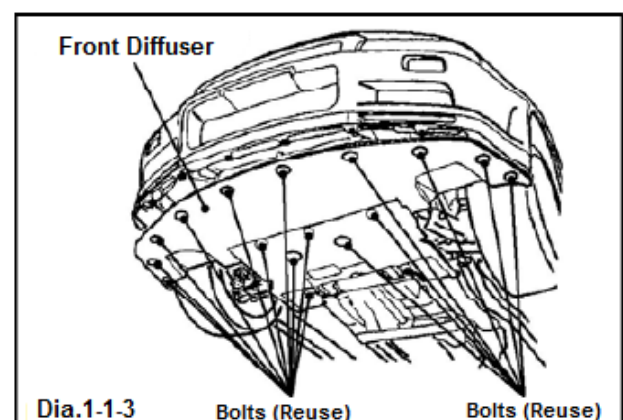

1-2. Drainage of Coolant and Engine Oil

- (1) Loosen the drain bolt on the bottom of the radiator, and drain the coolant. (Dia.1-2-1)

 CAUTION
Make sure the engine bay temperature has cooled down before installation. Failure to do so may lead to severe burns.

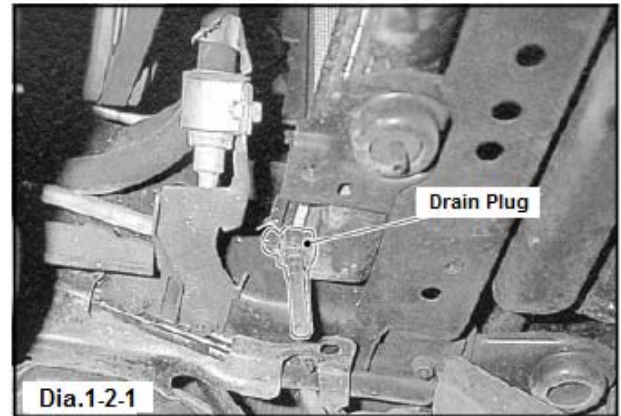

- (2) Loosen the drain bolt on the bottom of the engine oil pan, and drain the engine oil.

1-3. Removal of Front Pipe

- (1) Remove 4 bolts, and remove the CAT cover. (Dia.1-3-1)

NOTE The removed 4 bolts will be reused later.

- (2) Remove 4 nuts on the turbocharger side and 2 bolts on the CAT side. Remove the front pipe. (Dia.1-3-1)

NOTE The removed 4 bolts and 4 nuts will be reused later.

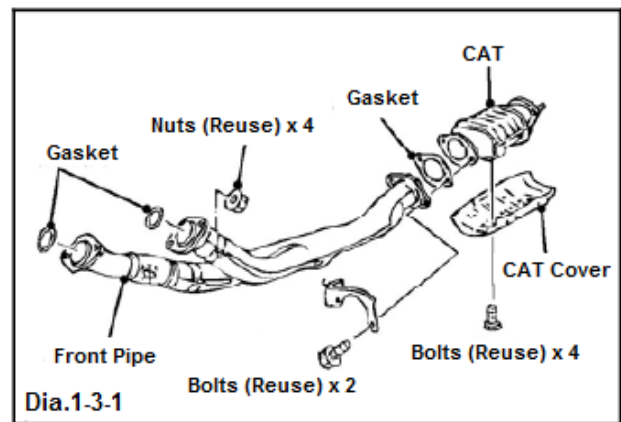

1-4. Removal of Air Cleaner

1-4-1. Removal of Air Cleaner (BNR32)

- (1) Remove the connector from the rear airflow meter. (Dia.1-4-1-1)
- (2) Loosen the hose band. (Dia.1-4-1-1)

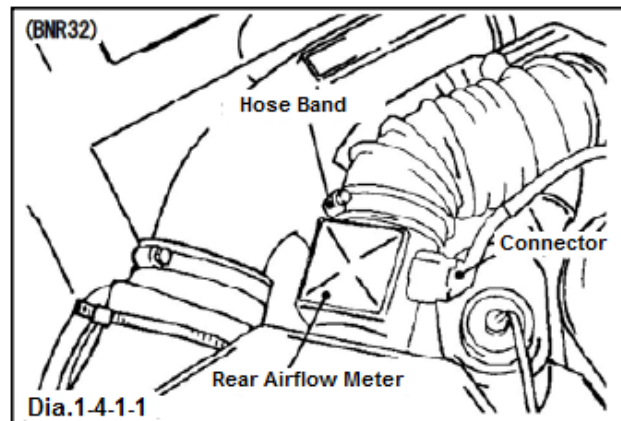

- (3) Remove the connector from the front airflow meter. (Dia.1-4-1-2)
- (4) Loosen the hose band. (Dia.1-4-1-2)

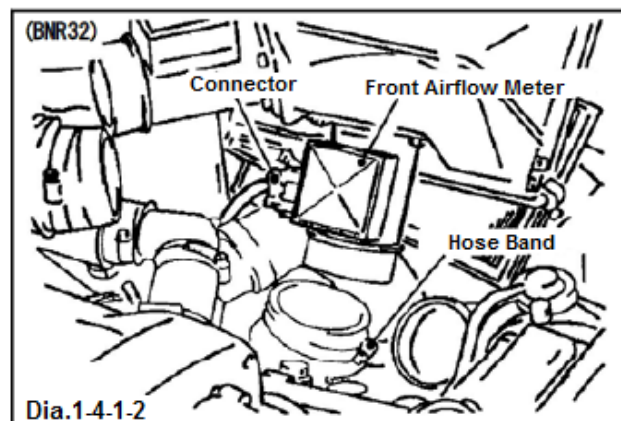

- (5) Remove 4 clips, and remove the air cleaner cover. (Dia.1-4-1-3)
- (6) Remove the air cleaner. (Dia.1-4-1-3)
- (7) Remove 2 bolts from inside the case and another 2 bolts from outside the case). Remove the air cleaner case. (Dia.1-4-1-3)

NOTE The removed 4 bolts will be reused later.

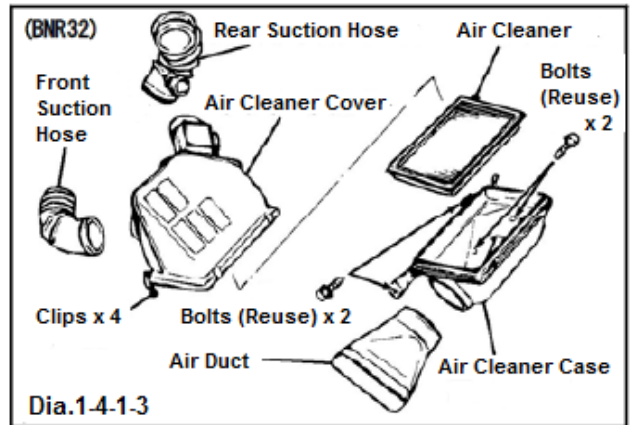

1-4-2. Removal of Air Cleaner (BCNR33 & BNR34)

- (1) Remove 2 clips, and remove the air duct (air intake side). (Dia.1-4-2-1)
- (2) To remove the air cleaner case, push the air duct inside the left fender toward the direction of the arrow shown in Diagram 1-4-2-1.

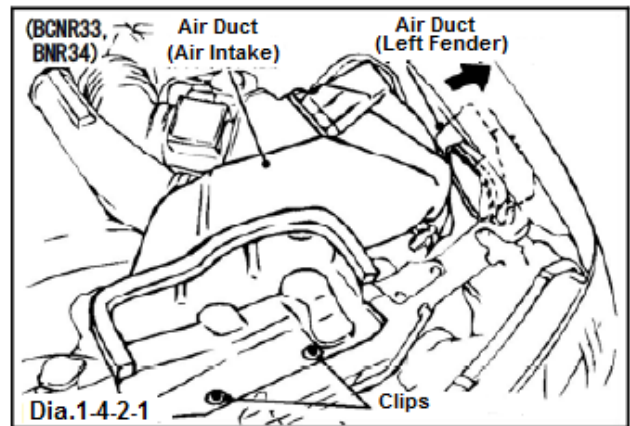

- (3) Remove 2 bolts. (Dia.1-4-2-2)

NOTE The removed 2 bolts will be reused later.

- (4) Remove 4 clips, and remove the air cleaner cover. (Dia.1-4-2-2)
- (5) Remove the air cleaner. (Dia.1-4-2-2)

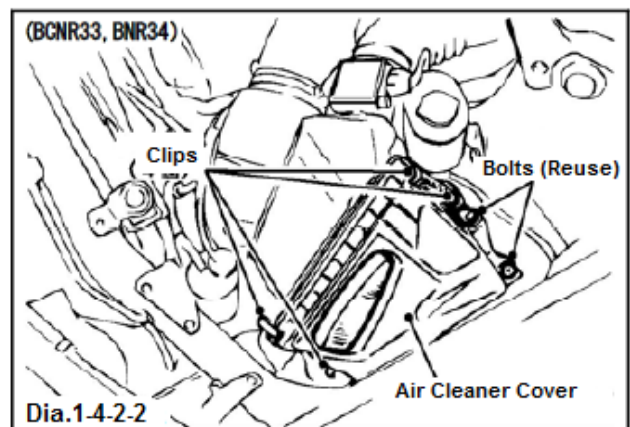

- (6) Loosen the hose band securing the front and rear airflow meters. (Dia.1-4-2-3)
- (7) Disconnect the connector from the front and rear airflow meters. (Dia.1-4-2-3)
- (8) Remove 2 bolts, and remove the air cleaner case. (Dia.1-4-2-3)

NOTE The removed 2 bolts will be reused later.

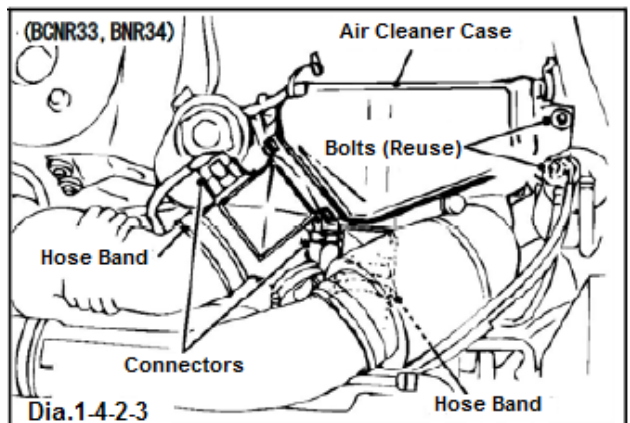

1-5. Removal of Air Hose and Blow-by Hose

- (1) Loosen the hose band, and remove the air hose and blow-by hose. (Dia.1-5-1)

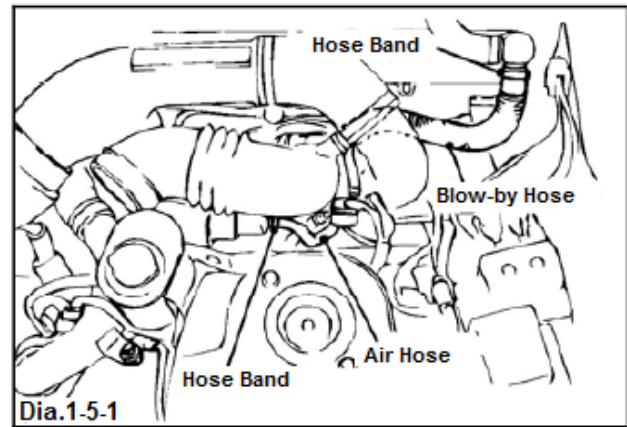

1-6. Removal of Recirculation Tube

- (1) Remove a bolt. (Dia.1-6-1)
NOTE The removed bolt will be reused later.
- (2) Loosen the hose band, and remove the recirculation tube. (Dia.1-6-1)

1-7. Removal of Suction Hose

- (1) Loosen the hose band and remove the front and rear suction hoses. (Dia.1-6-1)
- (2) Remove 2 bolts (Reuse) both from front and rear sides, and removes the suction pipe. (Dia.1-6-1)

NOTE The removed bolts will be reused later.

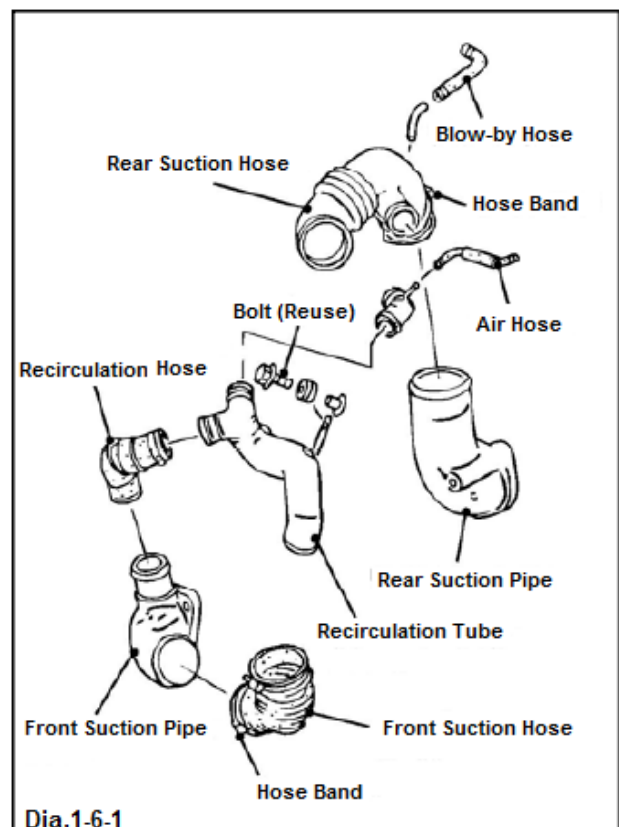

1-8. Removal of Strut Tower Bar

- (1) Remove 2 nuts both from right and left sides, and remove the front strut tower bar. (Dia.1-8-1) (BCNR33 & BNR34)

NOTE The removed 4 nuts will be reused later.

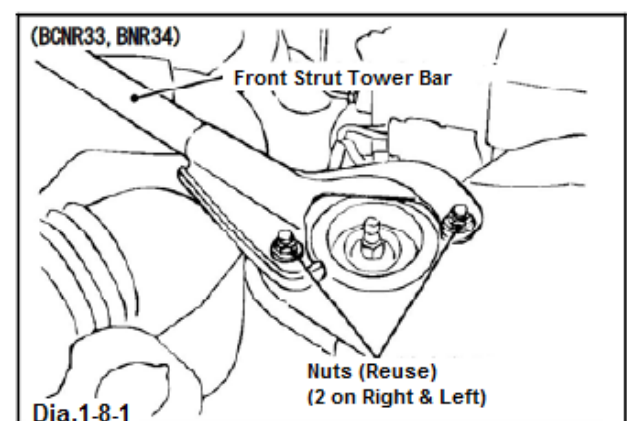

1-9. Removal of Turbocharger Assy

1-9-1. Removal of Chamber Pipe

- (1) Remove 2 air hoses. (Dia.1-9-1)
- (2) Remove 2 connectors.
- (3) Loosen the hose band and remove the chamber hose. (Dia.1-9-1)
- (4) Remove 2 bolts and 3 nuts, and remove the chamber pipe. (Dia.1-9-1)

NOTE The removed 2 bolts and 3 nuts will be reused later.

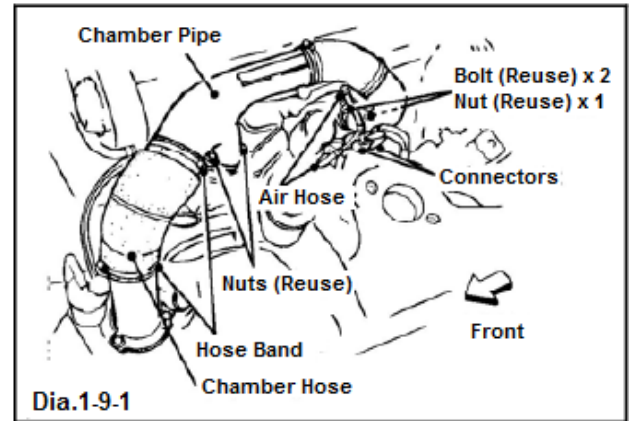

1-9-2. Removal of O2 Sensor

- (1) Remove the O2 sensor. (Dia.1-9-2)

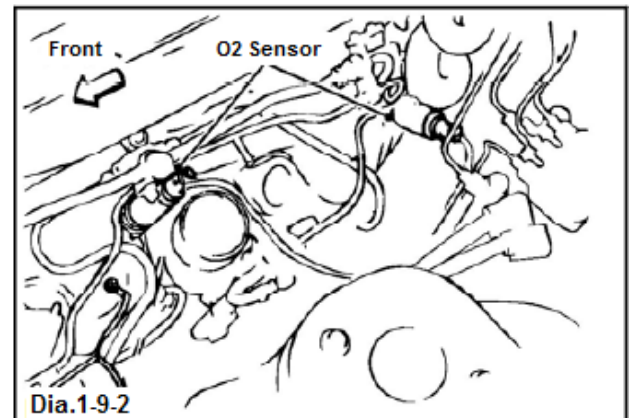

1-9-3. Removal of Water Return Tube

- (1) Remove the water return tube (A) from 1 to 4 in order. (Dia.1-9-3-1)

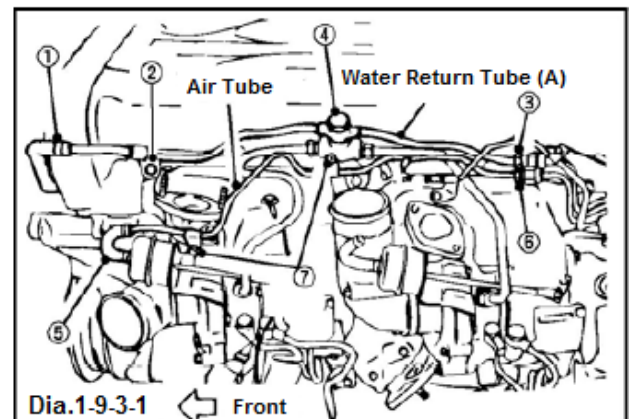

- (2) Remove the air tube from 5 to 7 in order. (Dia.1-9-3-1)

NOTE

Do not remove ④ Bolt from the water connector.

- (3) Remove ①, ②, ③, and M8 bolt under the water connector in Diagram 1-9-3-1; then remove the water return tube (A).

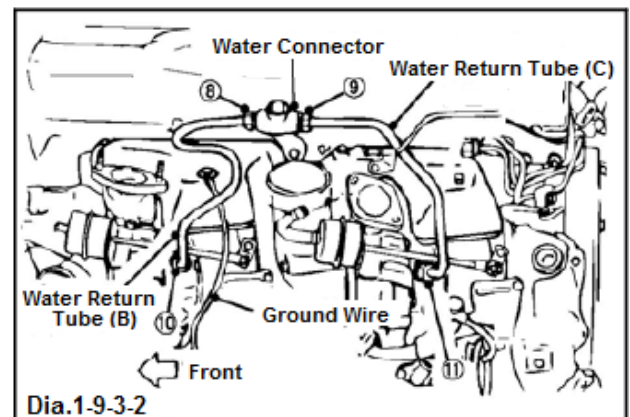

1-9-4. Removal of Exhaust Manifold Cover

- (1) Remove the ground wire from the front exhaust manifold cover. (Dia.1-9-4)
- (2) Remove 3 bolts both from front and rear sides, and removes the front and rear exhaust manifold covers. (Dia.1-9-4)

1-9-5. Removal of Outlet Tube

- (1) Remove 2 bolts, and remove the outlet tube from the front turbocharger assy. (Dia.1-9-4)

NOTE The exhaust manifold cover and bolts removed from the outlet tube will be used later.

1-9-6. Removal of Banjo Bolt

- (1) Remove the oil feed banjo bolt and water feed banjo bolt both from front and rear turbocharger assemblies. (Dia.1-9-6)

1-9-7. Removal of Oil Return Hose

- (1) Loosen the hose band and remove the front oil return hose from the oil outlet pipe. (Dia.1-9-7-1)
- (2) Remove 2 M8 bolts and a M6 bolt, and remove the bracket from the front turbocharger assy. (Dia.1-9-7-1)

NOTE The removed 3 bolts will be reused later.

- (3) Loosen the hose band and remove the rear oil return hose from the oil outlet pipe. (Dia.1-9-7-2)

- (4) Remove 2 M8 bolts and a M6 bolt, and remove the bracket from the rear turbocharger assy. (Dia.1-9-7-2)

NOTE The removed 3 bolts will be reused later.

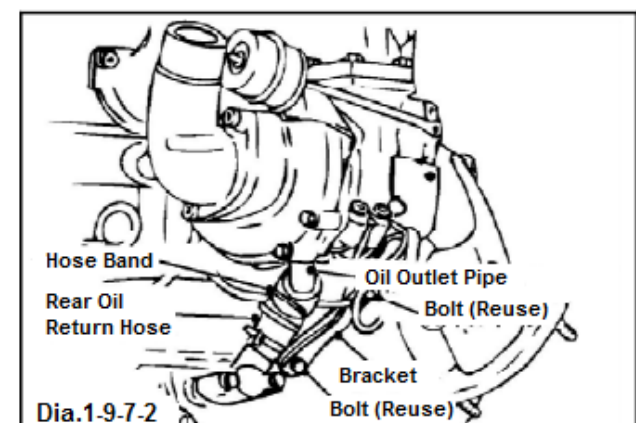
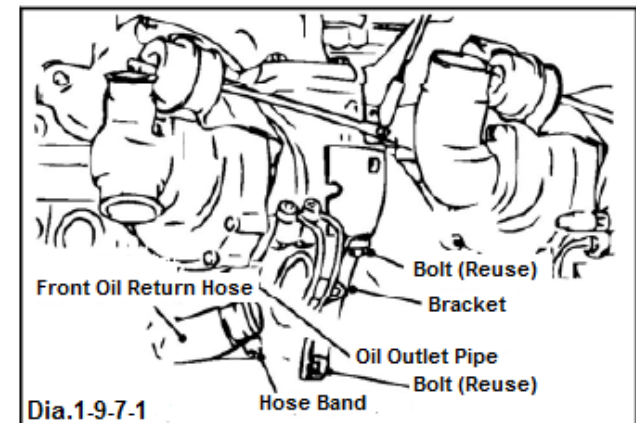
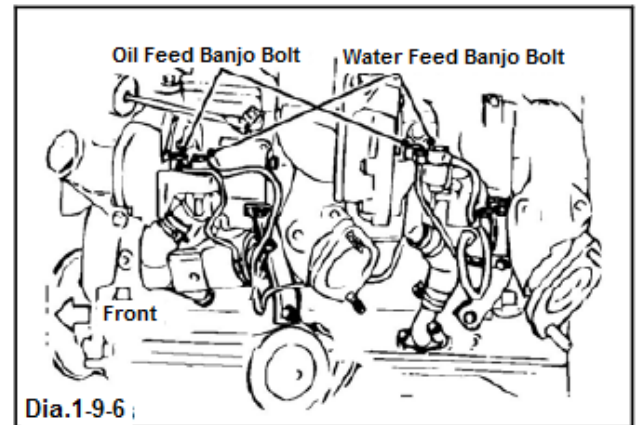
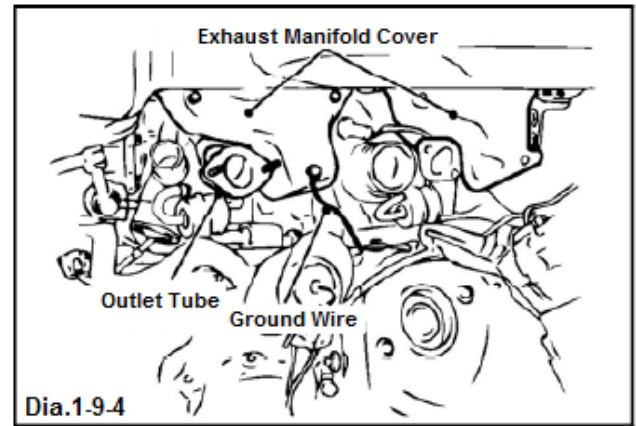

1-9-8. Removal of Exhaust Manifold

- (1) Release the lock plate's tab of both front and rear exhaust manifolds and turbocharger, and remove 4 nuts both from front and rear sides. (Dia.1-9-8-1)

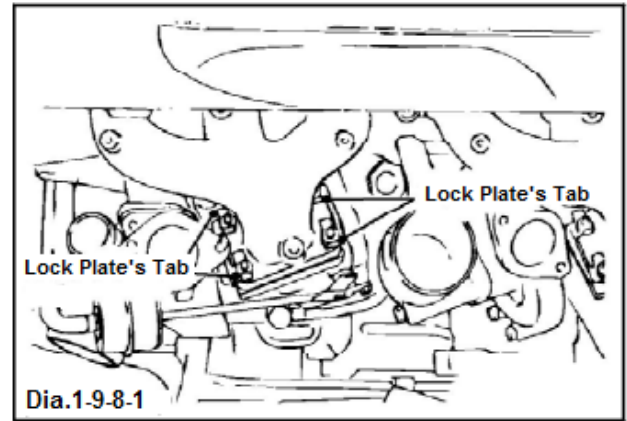

- (2) Remove both front and rear turbochargers from the exhaust manifolds. Leave the removed turbochargers to the lower side of the exhaust manifolds. (Dia.1-9-8-2)

NOTE

Make sure not to bend the oil feed tube and water feed tube in the lower part of the turbochargers.

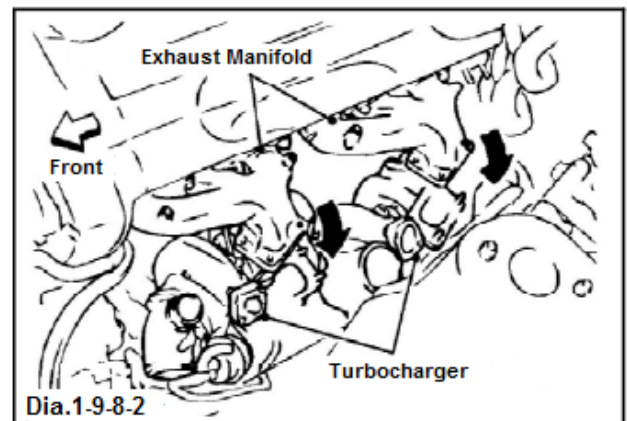

- (3) Remove 6 nuts both from front and rear sides, and remove the front and rear exhaust manifolds. (Dia.1-9-8-3)

NOTE The removed nuts will be reused later.

- (4) Pull both front and rear turbochargers out. (Dia.1-9-8-3)

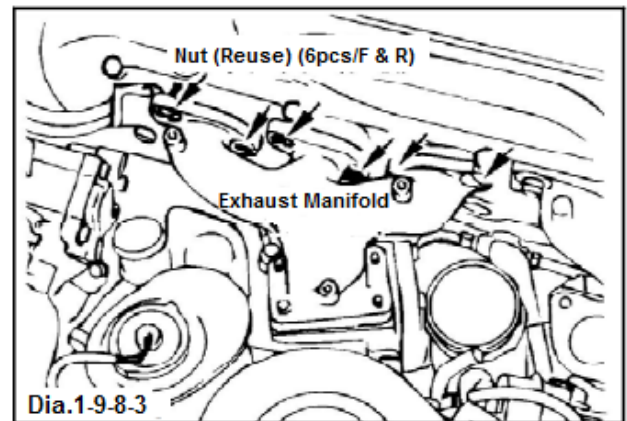

1-9-9. Removal of Turbocharger Cover

- (1) Remove 2 bolts both from front and rear sides, and remove the turbocharger cover both from front and rear turbochargers. (Dia.1-9-9)

NOTE The removed bolts will be reused later.

1-9-10. Removal of Extension

- (1) Remove 5 bolts (Reuse) both from front and rear sides, and remove the extension both from front and rear turbochargers. (Dia.1-9-9)
For BNR34 Spec-V, remove the exhaust temperature sensor as well.

NOTE The removed nuts will be reused later.

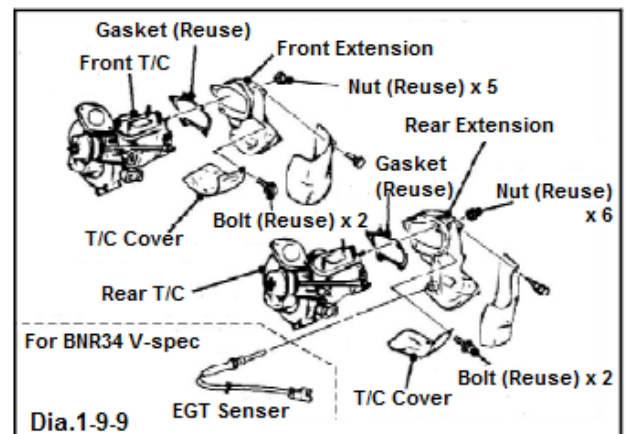

2. INSTALLATION OF KIT PARTS

2-1. Installation of Turbocharger Assy Hardware

(1) Install the provided Stub Bolts to both front and rear turbochargers. (Dia.2-1-1)

- Turbocharger Assembly (P1 x 2)
- Stud Bolt M8-1.25 (P11 x 18)

Tightening Torque N·m(kgf·m) T=17.6 – 23.5 (1.8-2.4)

NOTE The shorter threaded portion must be installed to the turbocharger side.

(2) Install the Bracket Heat Covers to both Turbochargers using the factory M6 bolts. (Dia.2-1-1)

- Bracket Heat Cover (P17 x 2)

Tightening Torque N·m(kgf·m) T=8.5 – 10 (0.8-1.0)

(3) Install the Water Feed Eye Bolts to both Turbochargers. (Dia.2-1-1)

- Water Tube Eye Bolt (P26 x 2)
- Cu Washer (P9 x 2)

Tightening Torque N·m(kgf·m) T=29.4 – 40.25 (3.0-4.1)

(4) Install the Oil Outlet Pipe to both Turbochargers using the provided M6 Flange Bolts. (Dia.2-1-1)

- Gasket Oil Out (P7 x 2)
- Oil Outlet Pipe Front (P19 x 1)
- Oil Outlet Pipe Rear (P20 x 1)
- Flange Bolt M6 (P18 x 4)

Tightening Torque N·m(kgf·m) T=8.5 – 10 (0.8-1.0)

(5) Install the factory hose and hose band to both front and rear Oil Outlet Pipe. (Dia.2-1-1)

NOTE Tighten the hose bands after the turbochargers are secured to the exhaust manifold.

This diagram shows the rear side.

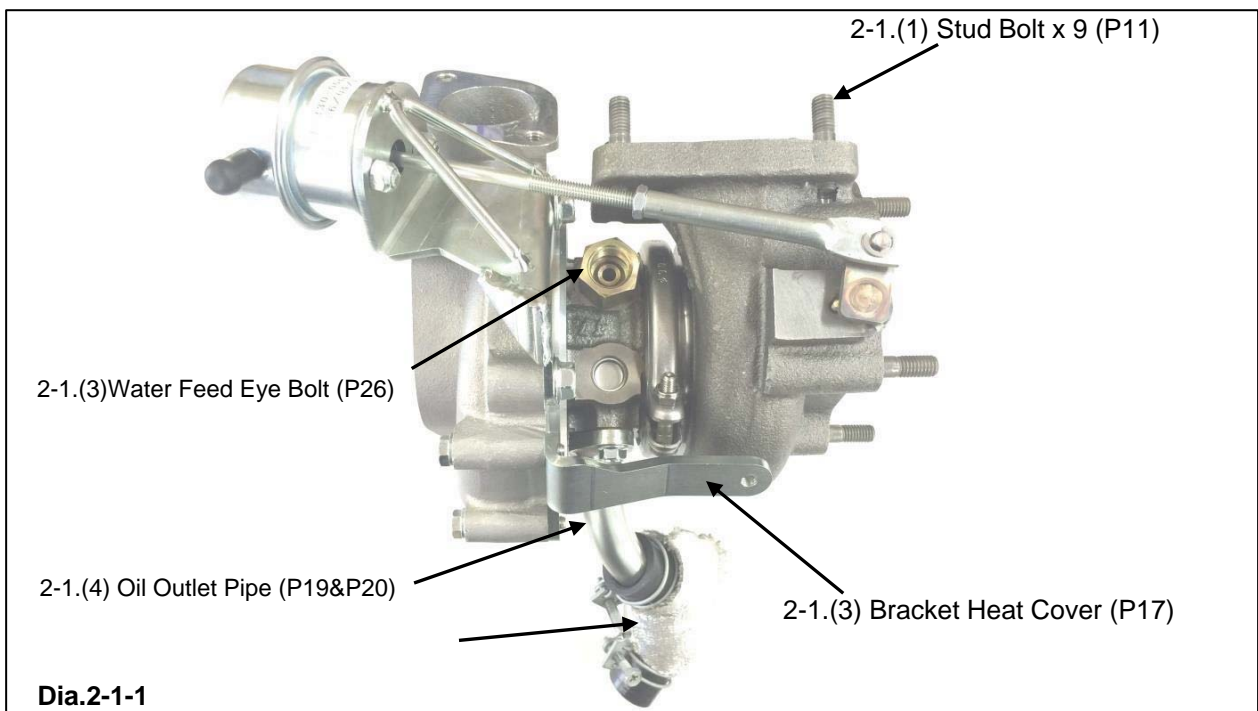

- (6) Install the Water Inlet Banjo Pipe to both Turbochargers using the factory banjo bolts. (Dia.2-1-2)
- Water Inlet Banjo Pipe (P25 x 2)
 - Cu Washer 12mm (P9 x 4)
- Tightening Torque N·m(kgf·m)**
T=20 –31 (2.0-3.2)

NOTE

The installation direction of each turbocharger is different.

- Install the pipe to the rear turbocharger right downward so the pipe becomes parallel with the compressor housing.
- Install the pipe to the front turbocharger so the clearance between the pipe end and the compressor housing (a bolt installation surface) becomes 5mm as shown in the diagram.

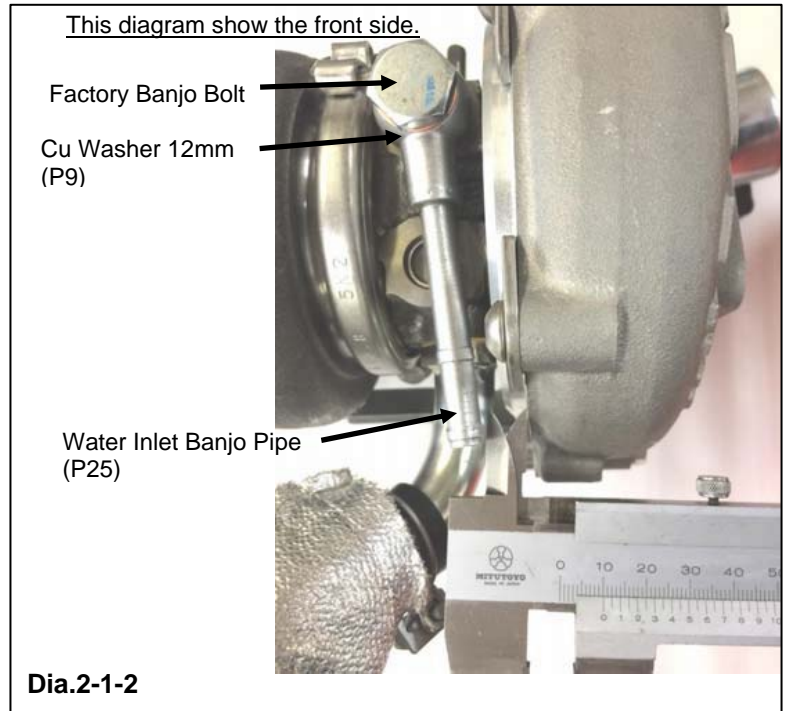

- (7) Install both front and rear extension, extension cover, and turbocharger cover to the Turbochargers using the factory bolts. For BNR34 V-spec, reinstall the exhaust gas temperature sensor as well.

- Factory M8 bolt
Tightening Torque N·m(kgf·m)
T=17.6 –23.5 (1.8-2.4)
- Factory M6 bolt
Tightening Torque N·m(kgf·m)
T=3.7 –4.9 (0.38-0.5)
- Exhaust gas temperature sensor (only for BRN34 V-spec)
Tightening Torque N·m(kgf·m)
T=17.6 –23.5 (1.8-2.4)

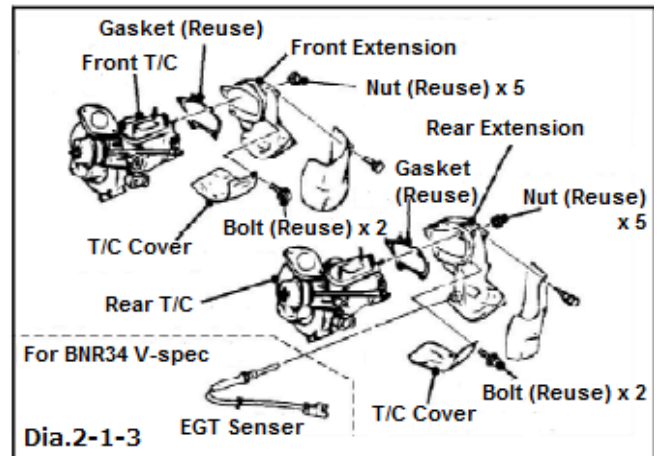

- (8) Cut the provided Water Hose and Insulation Tube to the length shown below:

Water Hose: 580mm (Front) and 200mm (Rear)
Insulation Tube: 310mm (Front) and 190mm (Rear)

- (9) Install the provided 8mm Adapter to the factory water union in the engine block. Install the Water Hose and Insulation Tube using the following parts as shown in Diagram 2-1-4:

- Water Hose (P28 x 1)
 - Insulation Tube (P30 x 1)
 - Hose Clip (P29 x4)
 - 8mm Adapter (P27 x 2)
 - Cu Washer 14mm (P10 x 2)
- Tightening Torque N·m(kgf·m)**
T=17.6 –23.5 (1.8-2.4)

NOTE

Put the Insulation Tube in the front to the rear (adapter's side).

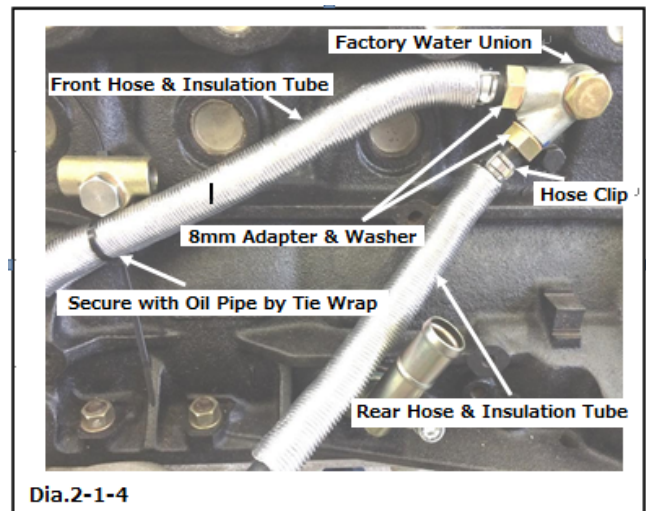

2-2. Installation of Turbocharger Assemblies

- (1) Insert the oil outlet hose from the rear turbocharger to the pipe in the cylinder block.
- (2) Temporarily install the rear Oil Inlet Pipe to the union in the cylinder block. Completely tighten the banjo bolt. (Dia.2-2-1)

- Oil Inlet Pipe Rear (P14 x 1)
- Oil Inlet Banjo Bolt (P21 x 1)
- Cu Washer 12mm (P9 x 2)

Tightening Torque N·m(kgf·m)
T=17.6 –23.5 (1.8-2.4)

- **Tighten those hose bands in the side of a flare nut and in the upper and lower side of oil outlet hose after the turbochargers are secured to the exhaust manifold.**

- (3) Install the rear exhaust manifold to the cylinder head. Install the rear Turbochargers to the exhaust manifold.

- Gasket Exhaust (P2 x 1)
- Self-Lock Nut M8 (P12 x 4)

Tightening Torque N·m(kgf·m)
T=22.5 –29.4 (2.3-3.0)

- ① **When installing the turbocharger to the exhaust manifold, insert the factory lock plates under the nuts, and tighten the nuts; then, bend the plate.**
- ② **Reuse the factory nuts and washers (6 pcs each) for the cylinder head side and the factory gasket between the turbocharger and exhaust manifold.**

- (4) Tighten the Oil Inlet Pipe's union Installation part (flare nut) in the engine block side. (Dia.2-2-2)

Tightening Torque N·m(kgf·m)
T=17.6 –23.5 (1.8-2.4)

- (5) Tighten those hose bands in the upper and lower side of the Oil Outlet Hose. (Dia.2-2-2)

Tightening Torque N·m(kgf·m)
T=3.7 –4.9 (0.38-0.5)

- (6) Insert the Water Hose to the Water Inlet Banjo Pipe. Secure the hose with the factory hose bands. (Dia.2-2-2)

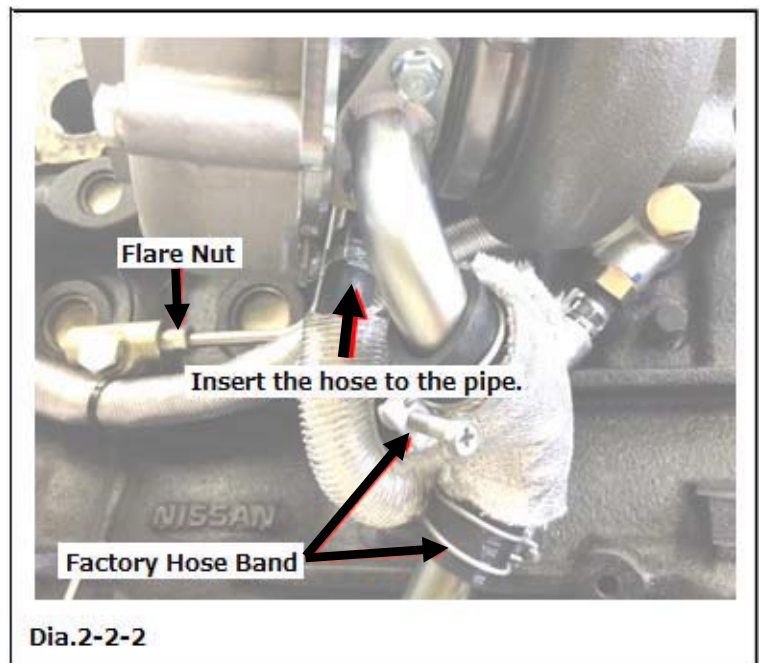
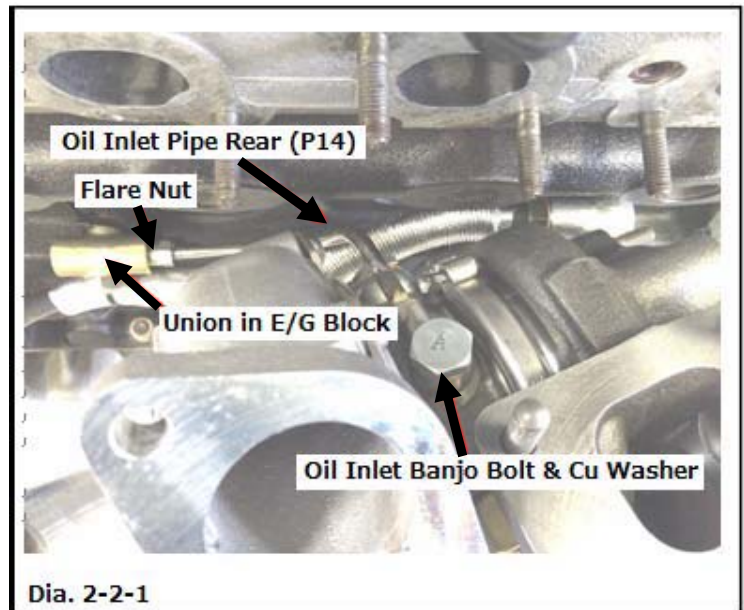

- (7) Insert the oil outlet hose from the front turbocharger to the pipe in the cylinder block.
- (8) Temporarily install the front Oil Inlet Pipe to the union in the cylinder block. Completely tighten the banjo bolt. (Dia.2-2-3)

- Oil Inlet Pipe Front (P13 x 1)
 - Oil Inlet Banjo Bolt (P21 x 1)
 - Cu Washer 12mm (P9 x 2)
- Tightening Torque N·m(kgf·m)
T=17.6 –23.5 (1.8-2.4)

- **Tighten those hose bands in the side of a flare nut and in the upper and lower side of oil outlet hose after the turbochargers are secured to the exhaust manifold.**

- (9) Install the front exhaust manifold to the cylinder head. Install the front Turbochargers to the exhaust manifold.

- Gasket Exhaust (P2 x 1)
 - Self-Lock Nut M8 (P12 x 4)
- Tightening Torque N·m(kgf·m)
T=22.5 –29.4 (2.3-3.0)

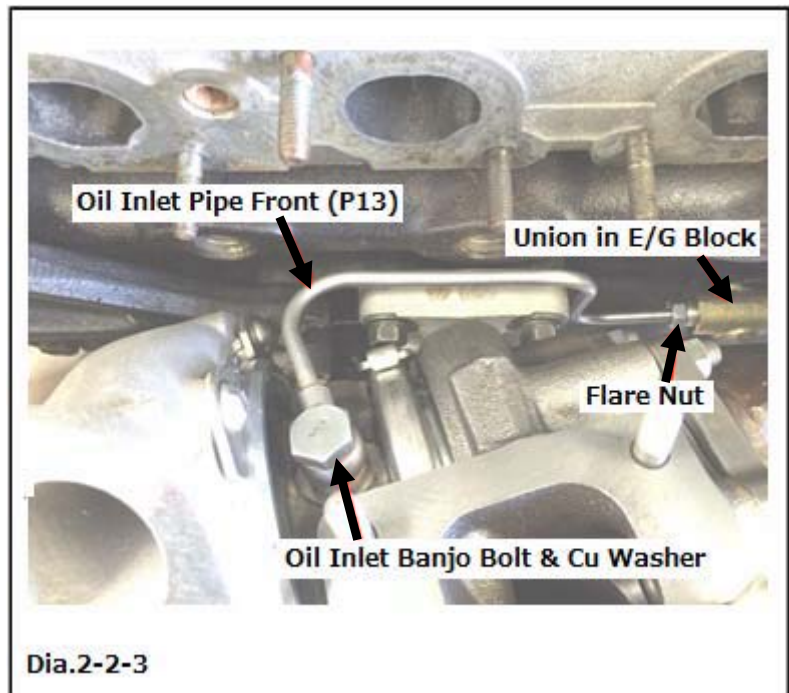

- ① **When installing the turbocharger to the exhaust manifold, insert the factory lock plates under the nuts, and tighten the nuts; then, bend the plate.**
- ② **Reuse the factory nuts and washers (6 pcs each) for the cylinder head side and the factory gasket between the turbocharger and exhaust manifold.**

- (10) Tighten the Oil Inlet Pipe's union installation part (flare nut) in the engine block side. (Dia.2-2-3)

Tightening Torque N·m(kgf·m)
T=17.6 –23.5 (1.8-2.4)

- (11) Tighten those hose bands in the upper and lower side of the Oil Outlet Hose.(Dia.2-2-4)

Tightening Torque N·m(kgf·m)
T=3.7 –4.9 (0.38-0.5)

- (12) Insert the Water Hose to the Water Inlet Banjo Pipe. Secure the hose with the factory hose bands.(Dia.2-2-4)

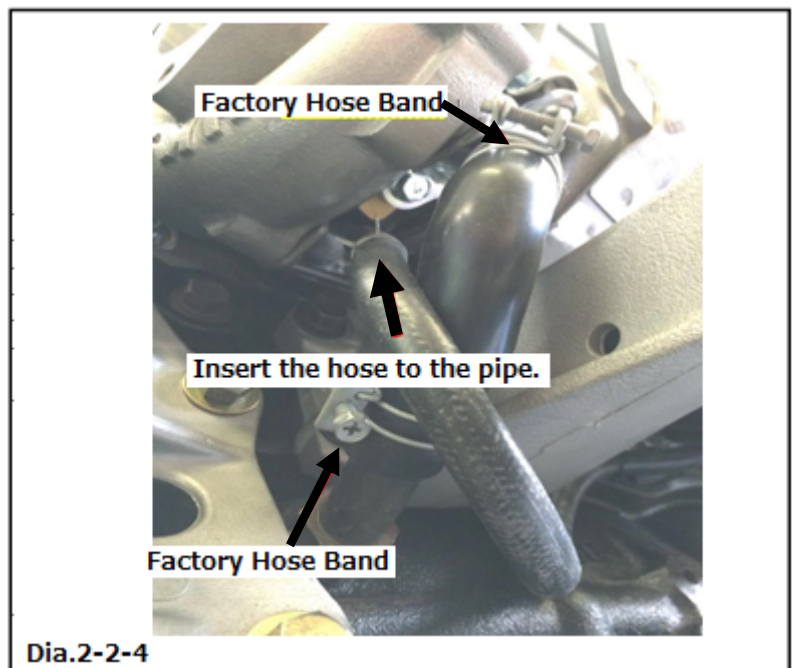

- ① **When connecting the Water Hose from the front Turbocharger, route the hose underneath the engine mount.**
- ② **Make sure the Oil Outlet Hose is not bent to prevent the oil leakage from the turbocharger.**

3. REINSTALLATION OF FACTORY PARTS

3-1. Reinstallation of Exhaust Manifold Cover

- (1) Reinstall the exhaust manifold cover to both front and rear. (Install the ground wire together to the front side.)
(Dia.3-1-1)

Tightening Torque N·m (kgf·m)
T=3.7-4.9 (0.38-0.5)

- (2) Reinstall the outlet tube as shown in Dia.3-1-1 using the following provided part.

- Gasket Chamber Pipe (P5).

Tightening Torque N·m (kgf·m)
T=15.7-20.6 (1.6-2.1)

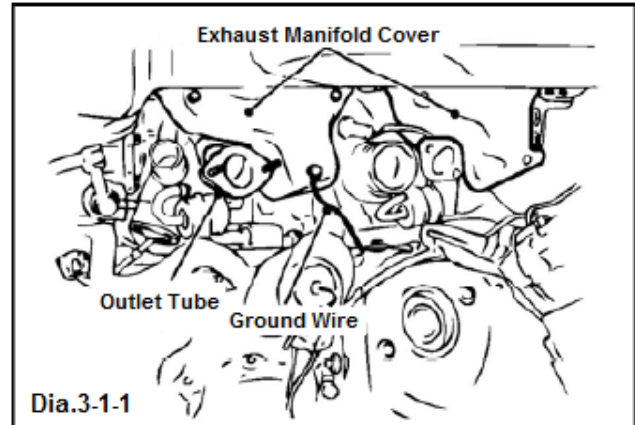

3-2. Reinstallation of Turbocharger Bracket

- (1) Reinstall the turbocharger bracket to both front and rear turbochargers.
Tightening Torque N·m (kgf·m) T=15.7-20.6 (1.6-2.1)

3-3. Reinstallation of Water Return Tube

- (1) Temporarily install the water return tube to both front and rear turbochargers.
(Dia.3-3-1)
The installation angle of the turbocharger is different; therefore, the water return tube comes to the front as shown in Dia. 3-3-1.

- (2) Bend the pipe while pushing the water return tube toward the cylinder head.
Tighten the factory M8 bolt.

- (3) Completely tighten the flare nuts in 4 positions.

Tightening Torque N·m (kgf·m)
T=29.4-40.25 (3.0-4.1)

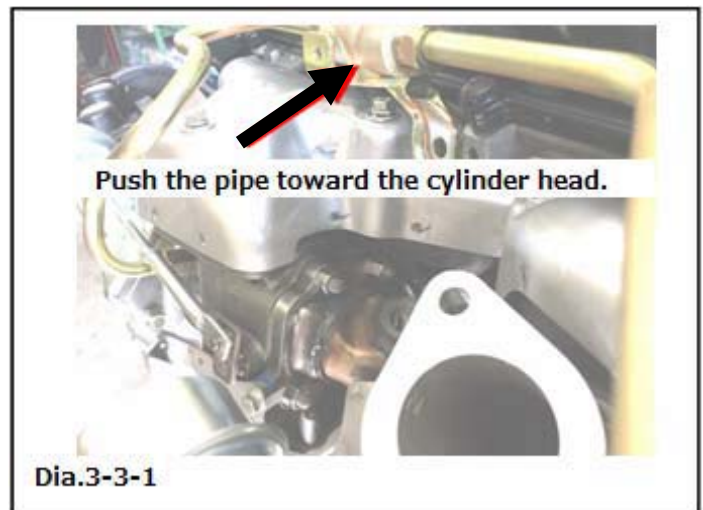

If the water return tube may come into contact with the actuator rod, loosen the M8 bolt securing the bracket, and adjust the actuator rod position so adequate clearance between the tube and rod is secured.

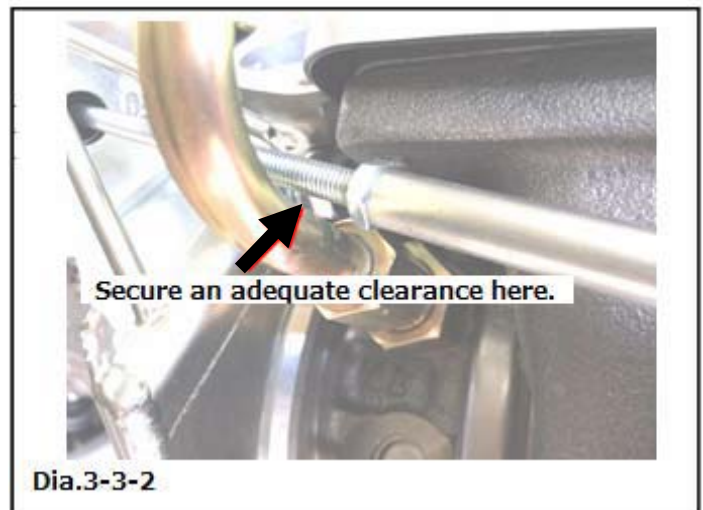

3-4. Piping of Actuators

- (1) Install the provided Rubber Cap 6mm (P8) and Tie Wrap(S) (P19) to the vacuum hose as shown in Diagram 3-4-1.

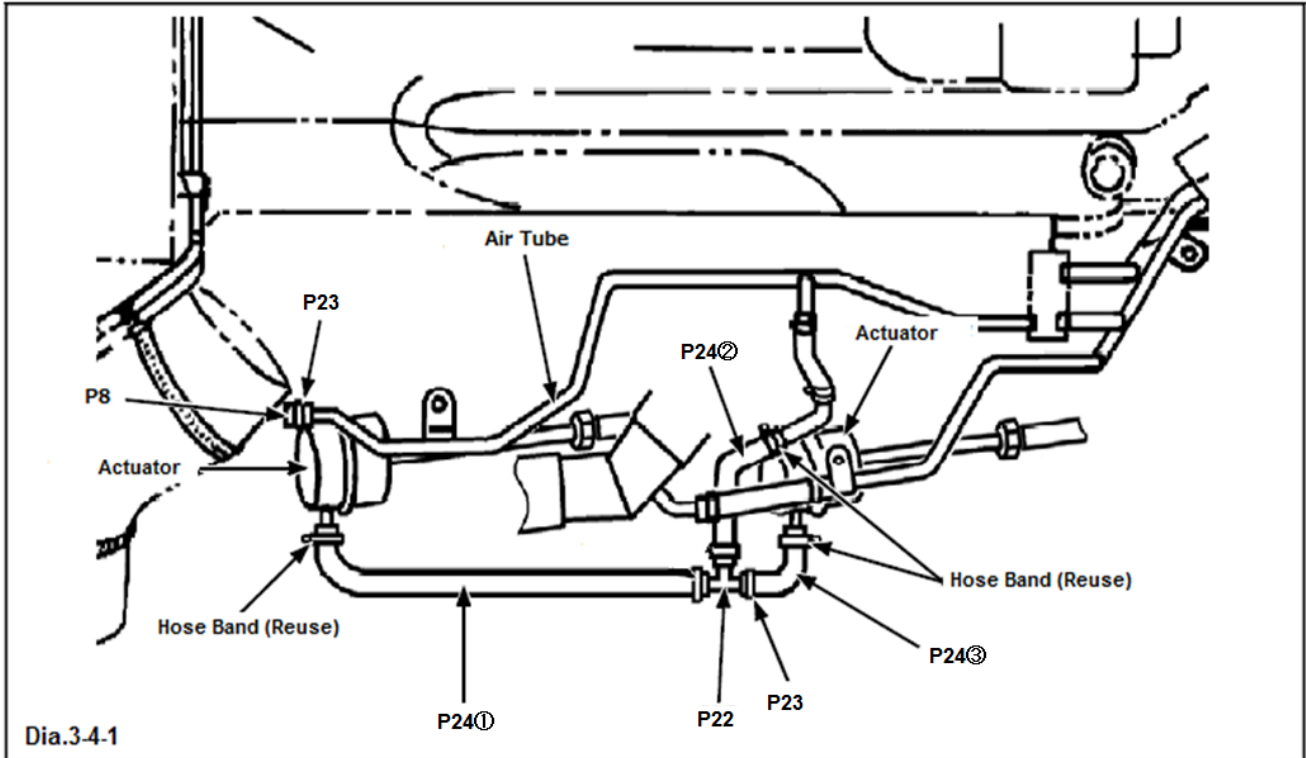

- (2) Cut the provided Oil Resistant Hose (P20) to the following lengths:

- ① 280mm
- ② 140mm
- ③ 80mm

- (3) Connect these hoses using the T-fitting (P18) and Tie Wraps (S) (P19) as shown in Diagram 3-4-1.

- (4) Remove the coupler since the factory boost control valve is not used.

3-5. Reinstallation of O2 Sensor

- (1) Reinstall the O2 sensors to the front and rear extensions. (Dia.3-5-1)

Tightening Torque N·m (kgf·m)
T=40.2-50.0 (4.1-5.1)

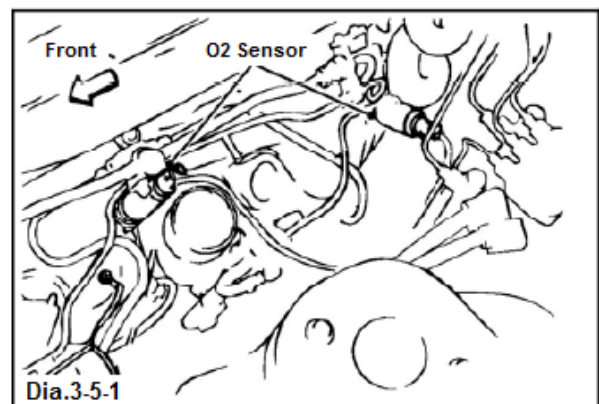

3-6. Reinstallation of Chamber Pipe

- Reinstall the chamber pipe using the following provided part and factory bolts and nuts. (Dia.3-6-1)

- Gasket Chamber Pipe(P5 x 2)
- Factory bolt x 2
- Factory nut x 3

Tightening Torque N·m (kgf·m)
 $T=15.7-20.6$ (1.6-2.1)

- Install the chamber hose using the hose band. (Dia.3-6-1)
- Connect 2 connectors. (Dia.3-6-1)
- Connect 2 air hoses. (Dia.3-6-1)

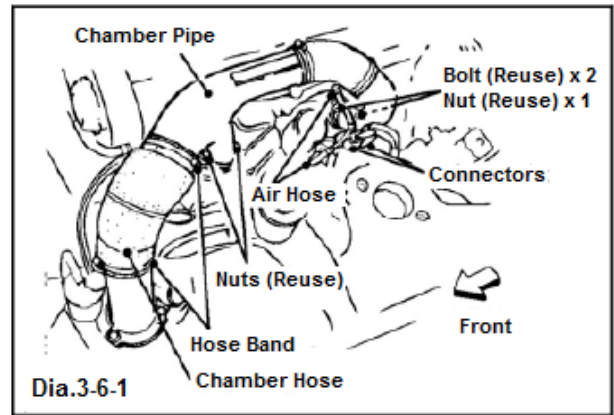

3-7. Reinstallation of Strut Tower Bar

- Reinstall the front strut tower bar using 2 factory nuts for both left and right sides. (Dia.3-7-1) (BCNR33, BNR32)

Tightening Torque N·m (kgf·m)
 $T=39.2-59.3$ (4.0-5.5)

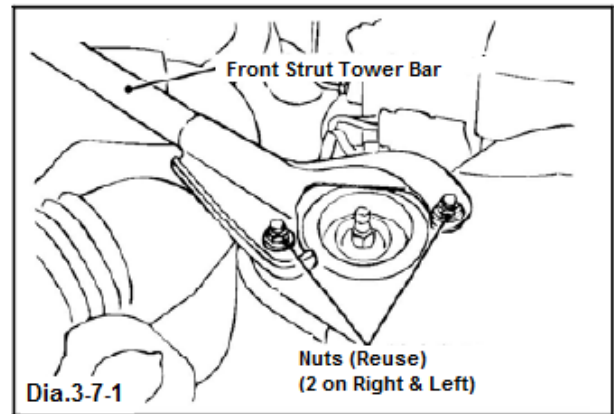

3-8. Reinstallation of Suction Hose

- Reinstall both front and rear suction pipes using the following provided parts. (P6 X 2). (Dia.3-8-1)
- Reinstall both front and rear suction hoses using the hose bands. (Dia.3-8-1)

3-9. Reinstallation of Recirculation Tube

- Connect the recirculation tube to the hose using a hose band. (Dia.3-8-1)
- Reinstall the recirculation tube to the body using a factory bolt..

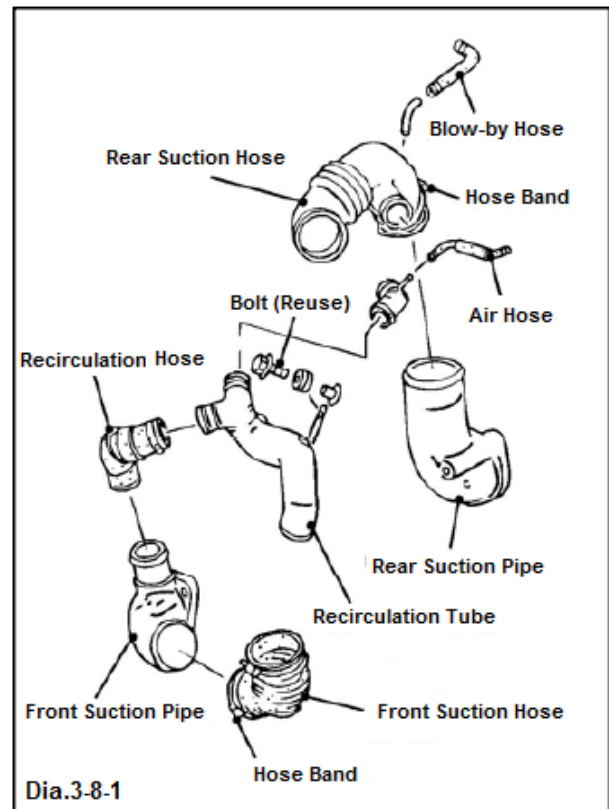

3-10. Reinstallation of Air Hose and Blow-by Hose

- (1) Reinstall the air hose and blow-by hose using the hose bands. (Dia.3-10-1)

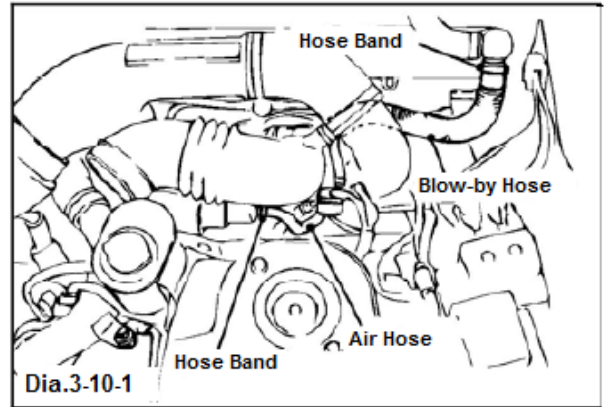

3-11. Reinstallation of Air Cleaner

3-11-1. Reinstallation of Air Cleaner (BNR32)

- (1) Reinstall the air cleaner case using 2 factory bolts both inside and outside of the case. (Dia.3-11-1-1)
- (2) Reinstall the air cleaner. (Dia.3-11-1-1)
- (3) Reinstall the air cleaner cover. Secure the cover using 4 clips. (Dia.3-11-1-1)

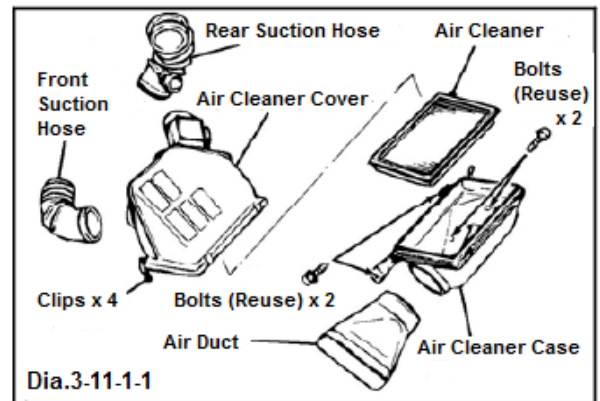

- (4) Reconnect the connector to the front airflow meter. (Dia.3-11-1-2)
- (5) Reinstall the front airflow meter to the front suction hose using a hose band. (Dia.3-11-1-2)

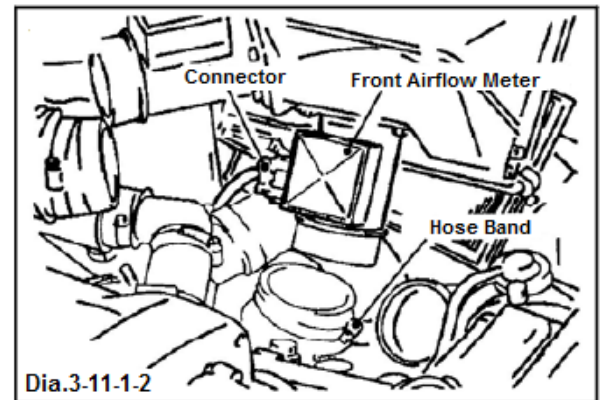

- (6) Reconnect the connector to the rear airflow meter. (Dia.3-11-1-3)
- (7) Reinstall the rear airflow meter using a hose band. (Dia.3-11-1-3)

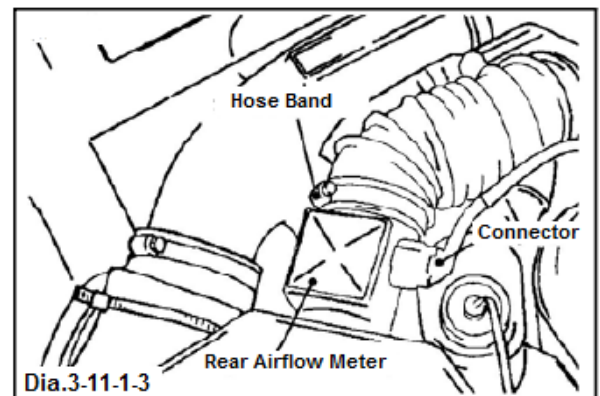

3-11-2. Reinstallation of Air Cleaner (BCNR33 & BNR34)

- (1) Reinstall the air cleaner case using 2 factory bolts. (Dia.3-11-2-1)
- (2) Reconnect the connectors to both front and rear airflow meters. (Dia.3-11-2-1)
- (3) Reinstall the front and rear suction hoses to the airflow meters using the hose bands. (Dia.3-11-2-1)

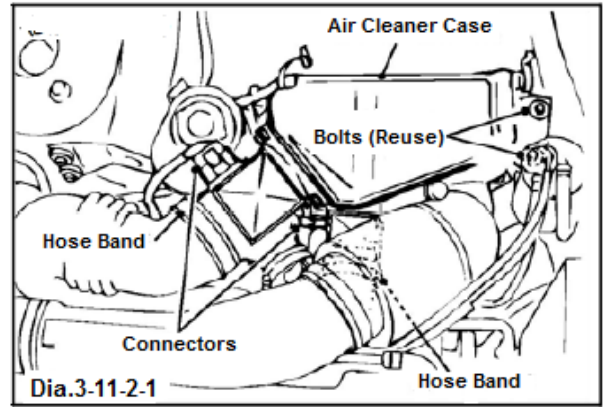

- (4) Reinstall the air cleaner. (Dia.3-11-2-2)
- (5) Reinstall the air cleaner cover. Secure the cover using 4 clips. (Dia.3-11-2-2)
- (6) Reinstall 2 factory bolts. (Dia.3-11-2-2)

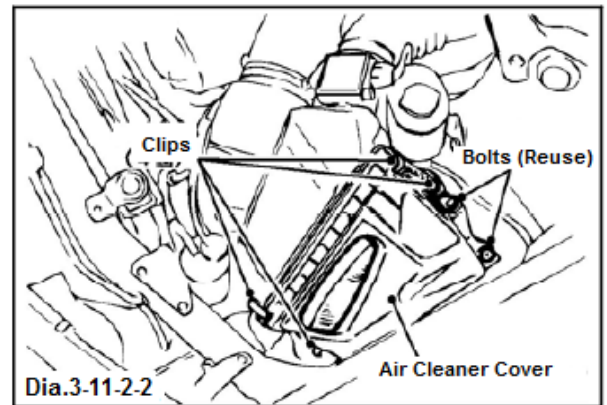

- (7) Pull the left fender side's air duct in the direction of the arrow and fit it closely to the air cleaner cover. (Dia.3-11-2-3)
- (8) Reinstall the air intake side's air duct using 2 factory clips. (Dia.3-11-2-3)

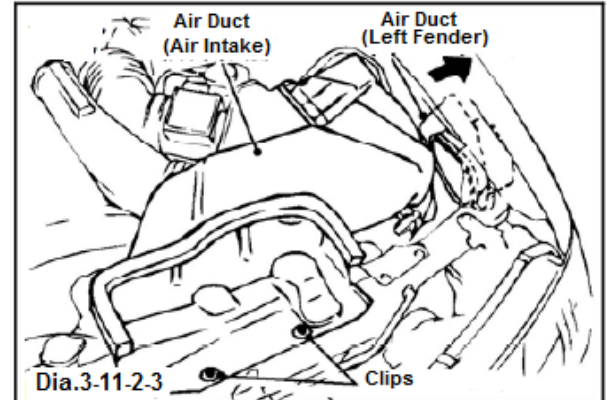

3-12. Reinstallation of Front Pipe

- (1) Reinstall the front pipe using the following provided parts. (Dia.3-12-1)
 - P3: Gasket Front Pipe 65mm x 2
 - P4: Gasket Universal Exhaust Sys 75mm x1
 - Factory bolts on the CAT side x 2

Tightening Torque N·m (kgf·m)

$$T=4.3-5.9 (0.44-0.60)$$

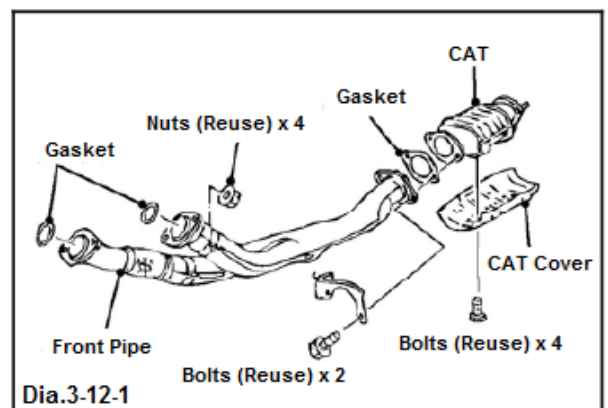

3-13. Reinstallation of Under Cover

3-13-1. Reinstallation of Under Cover (BNR32)

- (1) Reinstall the under cover using 13 factory screws. (Dia.3-13-1)

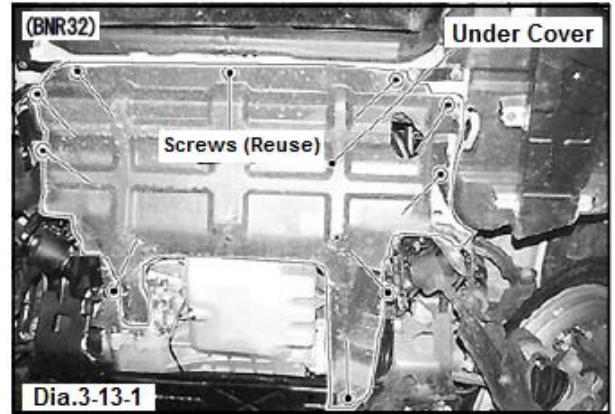

3-13-2. Reinstallation of Under Cover (BCNR33 & BNR34 Std.)

- (1) Reinstallation of the under cover using 10 factory screws. (Dia.3-13-2)

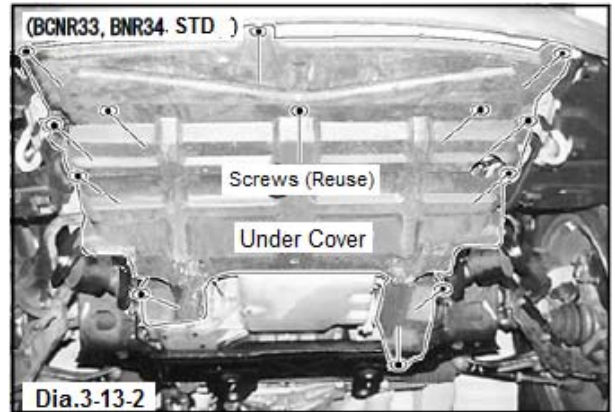

3-13-3. Reinstallation of Front Diffuser (BNR34 V-spec.)

- (1) Reinstall the front diffuser using 17 factory bolts. (Dia.3-13-3)

Tightening Torque N·m (kgf·m)

T=5.1-6.4 (0.52-0.66)

- (2) Reconnect the negative cable to the battery terminal.
- (3) Refill the coolant. Remove the air.
- (4) Refill the engine oil.
 - It is recommended to use HKS engine oil.

※ After the installation process is complete, check all items listed in the “Confirmation after Installation” section of the Instruction Manual.

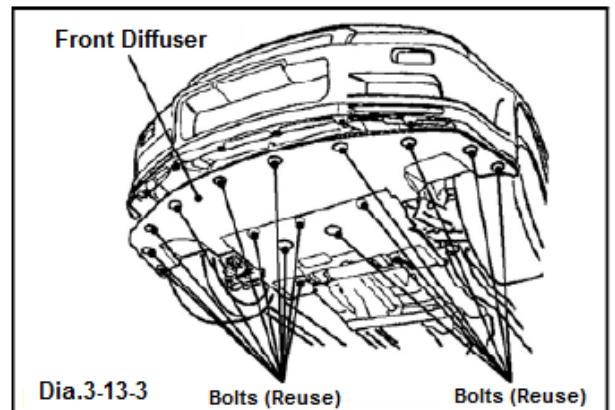

NOTE

- It is recommended to use HKS engine oil.

※ After the installation process is complete, check all items listed in the “Confirmation after Installation” section of the Instruction Manual.

CAUTION

- After installing this product, resetting by a fuel controller such as an HKS F-Con is required due to the engine output increase. Upgrade the pump, injectors, and/or head gasket if necessary.
- Adjust the boost pressure according to the engine specifications. Improper adjustment of the boost pressure may cause damage to the engine.



HKS Co., Ltd

7181,kitayama,fujinomiya-city,shizuoka-prefecture,418-0192,JAPAN

<http://www.hks-power.co.jp/>