

GTIII-RS SPORT TURBINE KIT INSTALLATION MANUAL



Installation must be done by a professional.
Read this manual prior to the installation.

Always have access to this manual as well as a factory service manual.

※ Make sure the vehicle is applicable to this kit.

NAME OF PRODUCT	SPORT TURBINE KIT
PART NUMBER	11004-AT004
APPLICATION	TOYOTA MARKII · CHASER · CRESTA (JZX100 / JZX110) CROWN (JZS171)
ENGINE	1JZ-GTE (VVT-i)
YEAR	TOYOTA MARKII · CHASER · CRESTA (JZX100): 1996/09 – 2001/06 MARK II (JZX110): 2000/11 – 2004/04 CROWN (JZS171): 2001/08 – 2003/12
REMARKS	<p>【 NOTE 】</p> <ul style="list-style-type: none"> ● In order to install this product to JZX110 or JZS171, the following factory part is required: 15491-88410 Turbo Oil Outlet Hose ● Settings of fuel and ignition using HKS F-Con or a similar device are required. ● The actuator's set boost pressure is 88.2kPa (0.9kgf/cm²). ● The engine reinforcement and fuel volume increase may be required when increasing the boost pressure. ● Without using a blow-off valve, air may blow back to the suction when throttle is released. ● HKS Racing Suction Kit (70020-AT106) and Super Power Flow Kit (70019-AT104) can be used with this product. ※φ100 Suction Adapter cannot be used with this product. ● In order to use φ100 Suction Adapter, the factory air tube No.1 must be replaced with a suction pipe and air cleaner. A suction pipe and air cleaner must be prepared separately.

REVISION OF MANUAL

Rev. Number	Date	Manual Number	Details
3-3.01	2017/04	E04211-T42080-00	1 st Edition
3-3.02	2018/04	E04211-T42081-00	2 nd Edition

NOTICE



This manual assumes that you have and know how to use the tools and equipment necessary to safely perform service operations on your vehicle. This manual assumes that you are familiar with typical automotive systems and basic service and repair procedures. Do not attempt to carry out the operations shown in this manual unless these assumptions are correct. Always have access to a factory repair manual. To avoid injury, follow the safety precautions contained in the factory repair manual.

ATTENTION













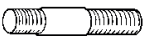
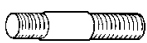
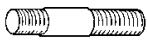



- This manual indicates items you need to pay attention to in order to install this product safely and lists precautions to avoid any possible damage and/or accidents.
- This product is an automobile part. Do not use for any other purposes.
- HKS will not be responsible for any damage caused by incorrect installation and/or use, or use after modification and/or dismantling of this product.
- This product was designed based on installation onto a specific factory vehicle.
- The specifications of this product are subject to change without notice.
- The instructions are subject to change without notice. Make sure to refer to the most recent instructions.











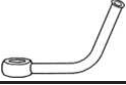





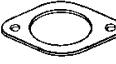



SAFETY PRECAUTIONS

The following precautions for use of this product are to prevent possible accidents and/or injuries and for proper use.

 WARNING	Indicates risk of serious injury and/or possible death.
 CAUTION	Indicates risk of damage to people or large-scale damage to property. (Large-scale damage is the damage caused by a product defect. Ex. Damage to a vehicle, burnout, etc.)

Parts List

No.	Description	QT	Image	Remarks
P1	Turbocharger Assembly	1		GTIII-RS
P2	Extension	1		
P3	Turbocharger Oil Outlet Pipe	1		
P4	Stud Bolt M10 10-7-25	4		
P5	Stud Bolt M10 10-6-20	3		
P6	Stud Bolt M8 7-10-14	7		
P7	Flat Washer M8	2		
P8	Spring Washer M8	2		
P9	Hexagon Bolt M9 L=20	2		
P10	Self-lock Nut M8	5		
P11	Hexagon Bolt M6 L=15	2		
P12	Oil Inlet Hose	1		
P13	Elbow F-F PT1/8	1		
P14	Oil Inlet Banjo 12mm PT1/8	1		
P15	Oil Inlet Banjo Bolt	1		"I" in the hex part. With Orifice
P16	Oil Line Adapter PT1/8 AN4	1		
P17	Oil Inlet Banjo 12mm AN4	1		
P18	Oil Inlet Banjo Bolt	2		With no letter in the hex part. (Turbine Side) Without Orifice
P19	Cu Washer 12mm	4		

P20	Water Pipe A	1		Long (for body side)
P21	Water Pipe B	1		Long (for engine block side)
P22	Water Banjo Bolt	2		
P23	Cu Washer 14mm	4		
P24	Water Hose 10mm	1		L=1500
P25	Hose Band #4	4		
P26	Extension Outlet Gasket	1		
P27	Catalyzer Outlet Gasket	1		
P28	Exhaust Manifold Outlet Gasket	1		
P29	O2 Sensor Gasket	1		
P30	Oil Outlet Pipe Gasket	1		
P31	Turbine Outlet Gasket	1		
P32	Corrugated Tube	1		
P33	Tie Wrap (L)	3		L=250
P34	Tie Wrap (M)	3		
P35	100mm Suction Adapter	1		
P36	Pin	2		
P37	Hex Socket Head Cap Bolt	6		M4
P38	Spring Washer M4	6		
P39	Installation Manual	1		
P40	Instruction Manual	1		

1. REMOVAL OF FACTORY PARTS

Before installation, disconnect the negative cable from the battery, and prepare new engine oil and coolant. Use blank caps and/or waste cloth if necessary. Use this instruction manual and the manufacturer's service manual as a reference.

- (1) Lift up a vehicle and remove the undercover.
- (2) Drain the engine coolant.
- (3) Remove the part ① to ⑯ shown in the diagram below.

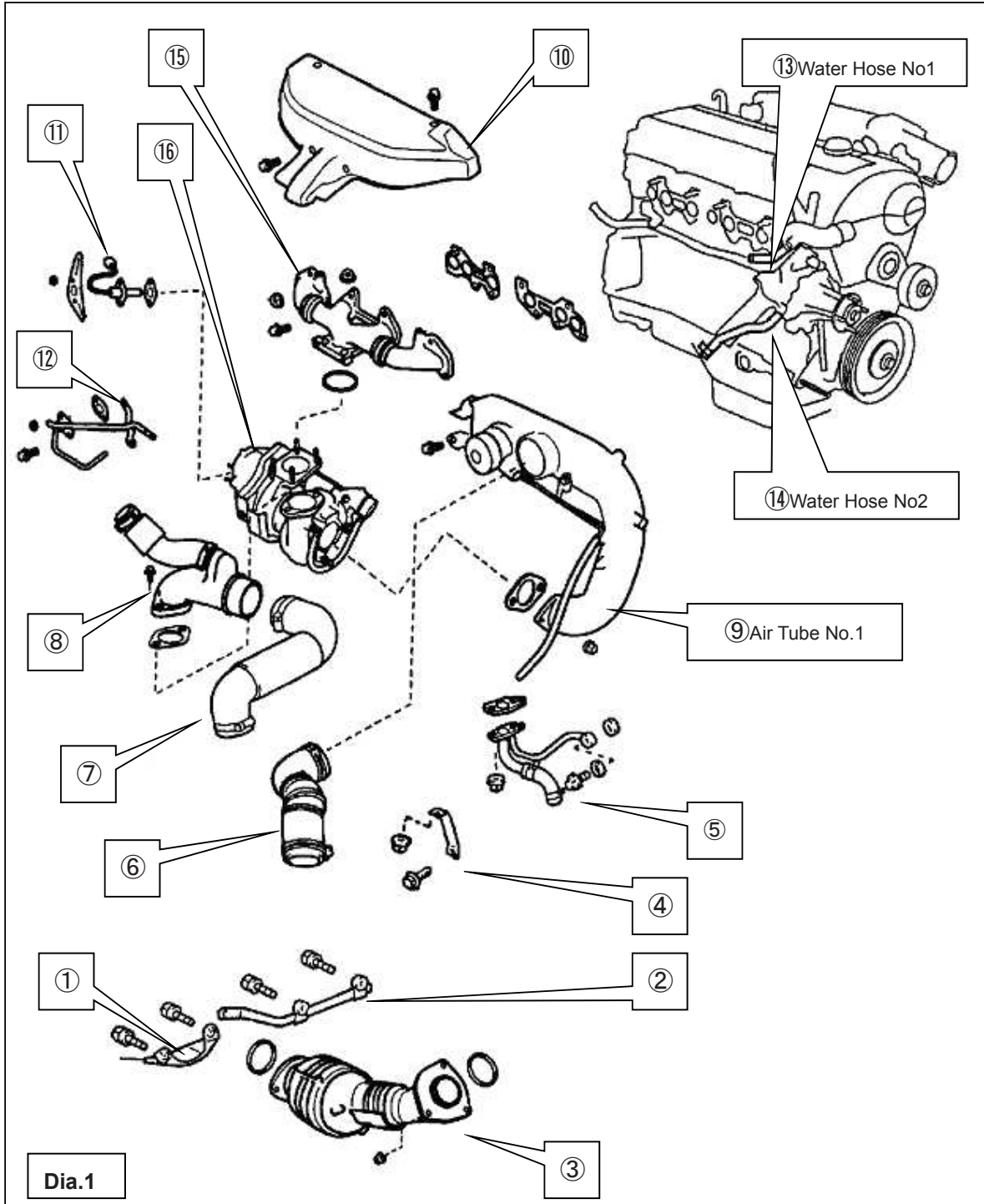

- (1) Install 3 parts (P13, P14, and P16) shown in Diagram 3 to the cylinder block using 2 parts (P18 and P19) shown in Diagram 4.

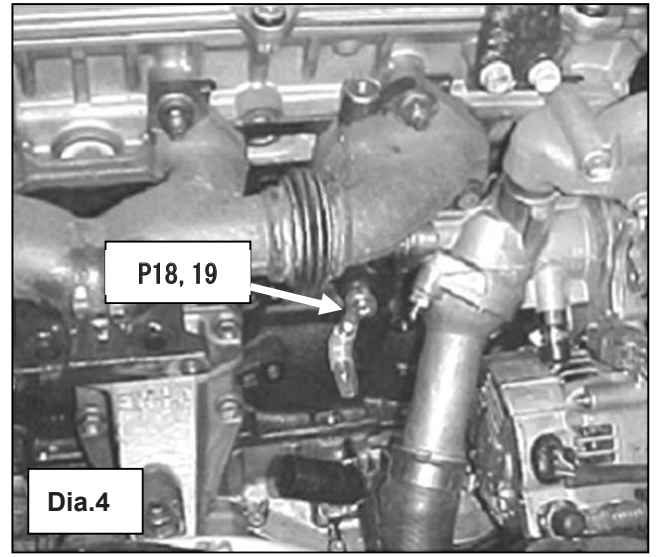
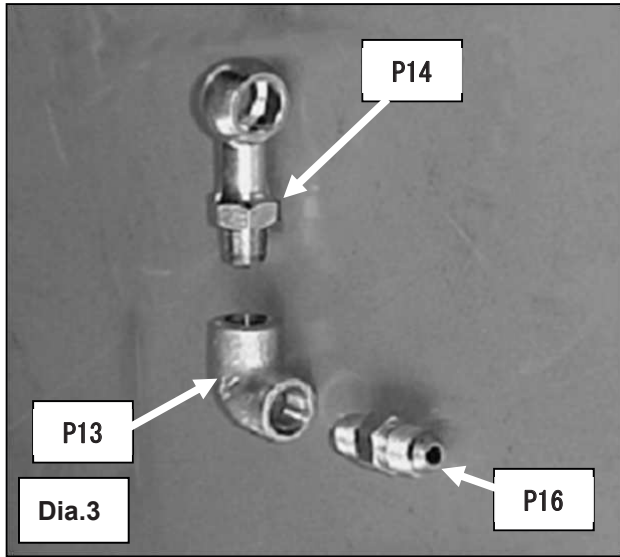

- P13 Elbow F-F PT1/8 x 1
- P14 Oil Inlet Banjo 12mm PT1/8 x 1
- P18 Oil Inlet Banjo Bolt (With no letter in the hex part.) x 1
- P16 Oil Line Adapter PT1/8 AN4 x 1
- P19 Cu Washer 12mm x 2

- (2) Cut the Water Hose (P24) to (A) 550mm and (B) 500mm.

- P24 Water Hose x 1

- (3) Prepare the Water Pipe A (P20) and Water Pipe B (P21) to the Turbocharger Assembly. Make sure to install them to the correct side.

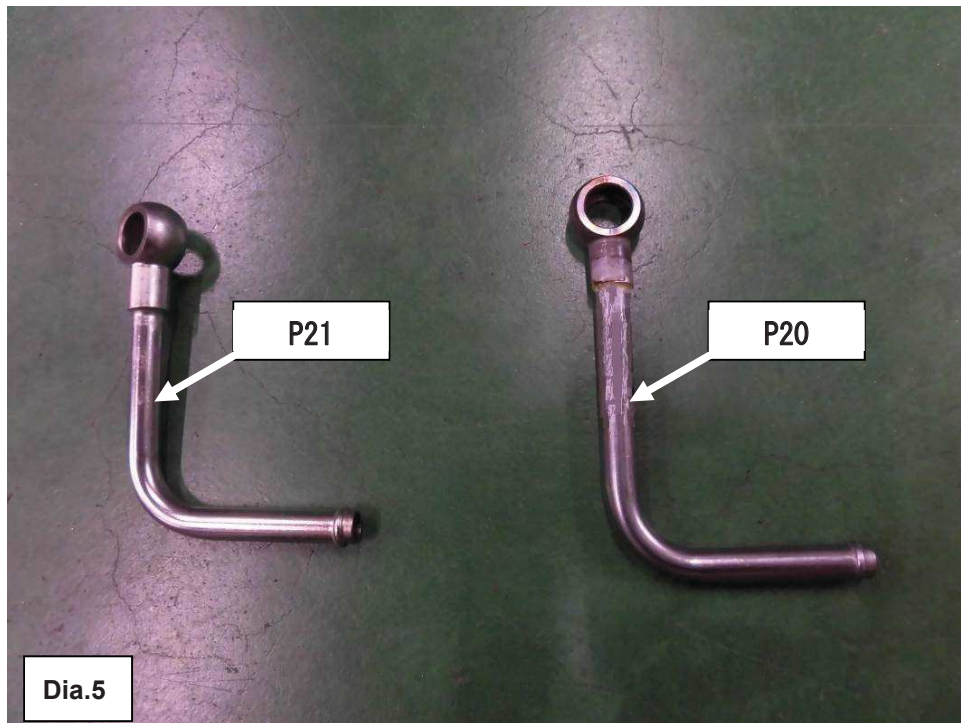

- (4) Install the Water Pipe A (P20) to the Turbocharger Assembly using one Water Banjo Bolt (P22) and two Cu Washer 14mm as shown in Diagram 6. Make sure to install the pipe in a correct orientation.

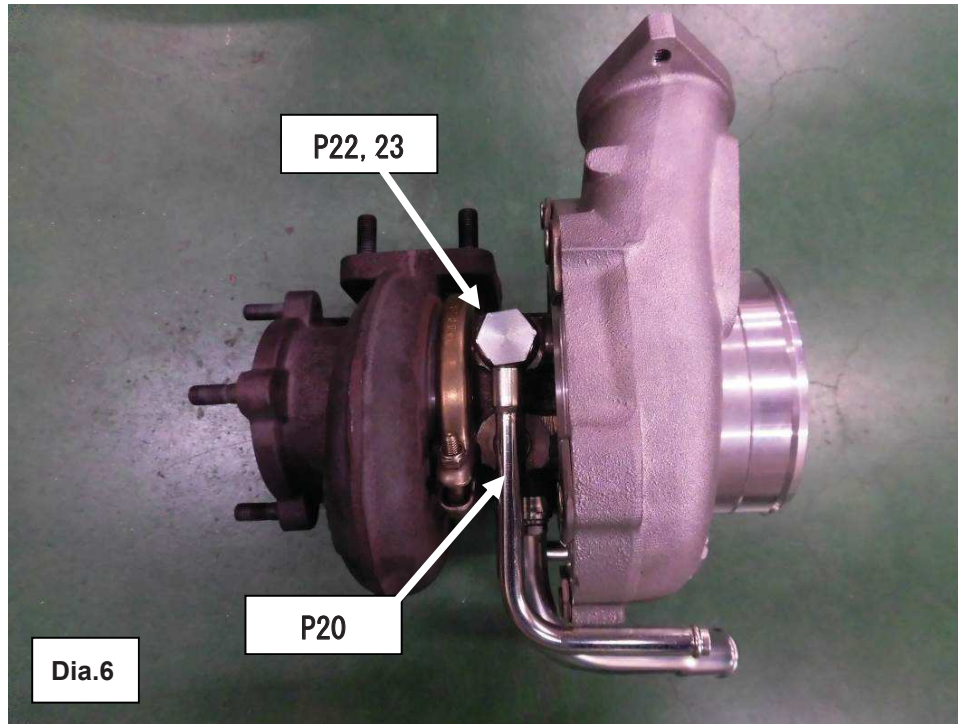

- (5) Install the Water Pipe B (P21) to the Turbocharger Assembly using one Water Banjo Bolt (P22) and two Cu Washer 14mm as shown in Diagram 7. Make sure to install the pipe in a correct orientation.

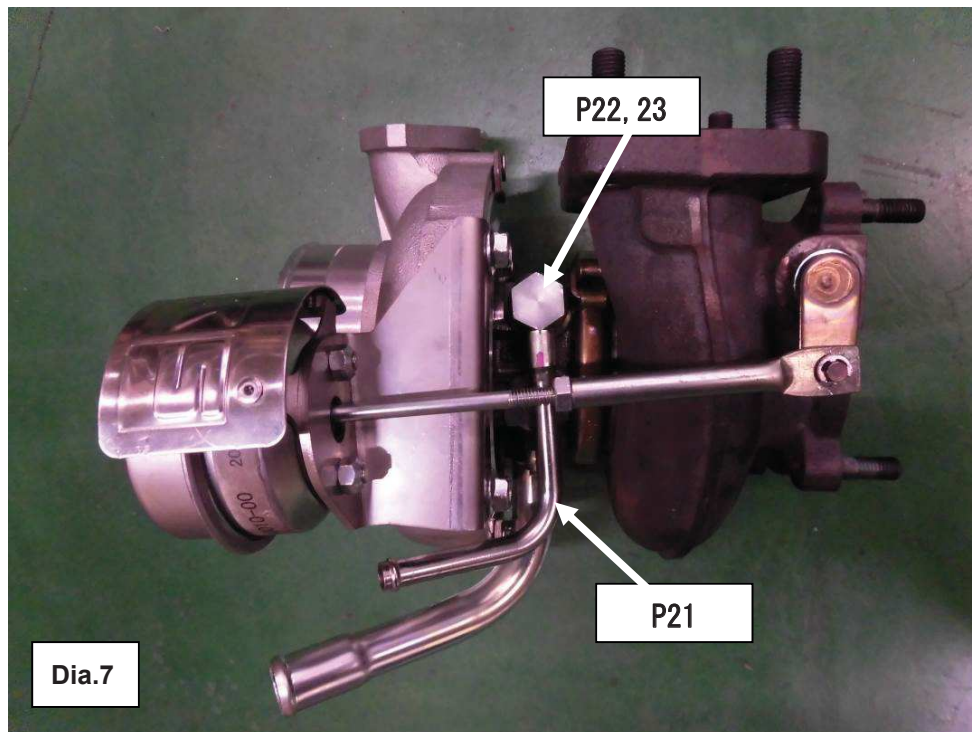

NOTE

- ※ Make sure to install the Water Pipe A and Water Pipe B so they don't come in contact with the compressor housing.

- P20 Water Pipe A x 1

- P21 Water Pipe B x 1
- P22 Water Banjo Bolt x 2
- P23 Cu Washer 14mm x 4

(6) Connect the 550mm Water Hose (A) to the Water Pipe A (P20), and the 500mm Water Hose (B) to the Water Pipe B (P21). Secure those hoses using the provided Hose Band #4.

- P24 Water Hose (A) and (B)
- P25 Hose Band #4 x 2

(7) Install the Oil Inlet Hose (P12) to the Turbocharger using the provided parts (P17, P18, and P19) as shown in Diagram 8..

NOTE

※ Before installing the Oil Inlet Hose, pour a small amount of the engine oil to the Turbocharger to prevent an initial lubrication failure at engine start.

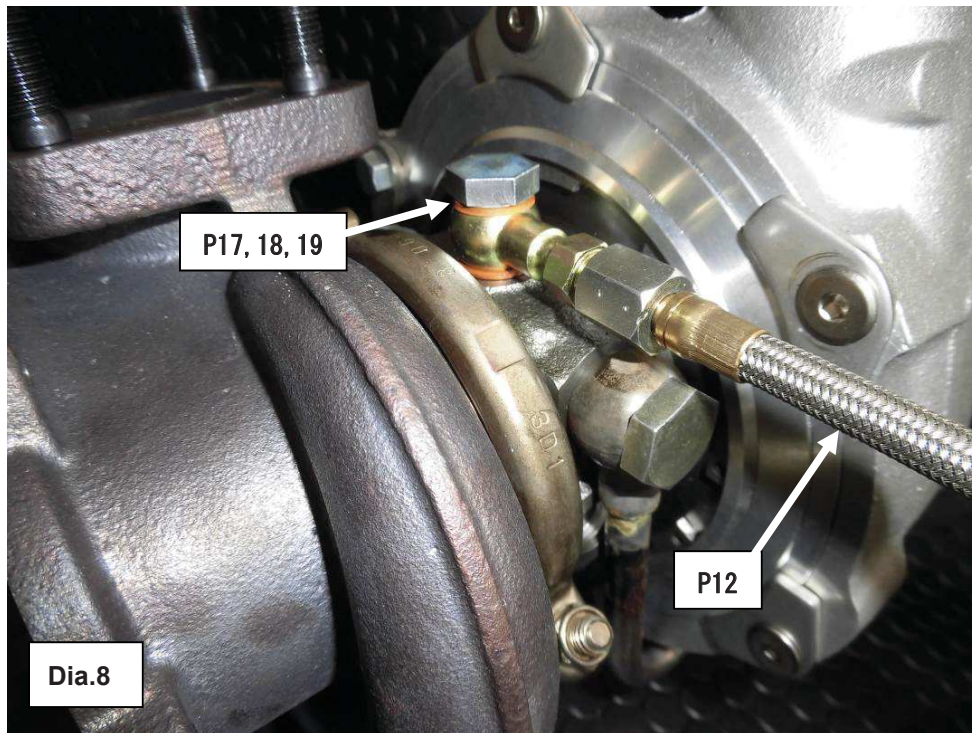

- P12 Oil Inlet Hose x 1
- P17 Oil Inlet Banjo 12mm AN4 x 1
- P18 Oil Inlet Banjo Bolt (With no letter in the hex part.) x 1
- P19 Cu Washer 12mm x 2

- (8) Insert the Oil Outlet Pipe Gasket (P30) between the Oil Outlet Pipe (P3) and the Turbocharger Assembly. Install the Oil Outlet Pipe to the Turbocharger Assembly using the provided Hexagon Bolt M6 L=15 (P11) as shown in Diagram 9.

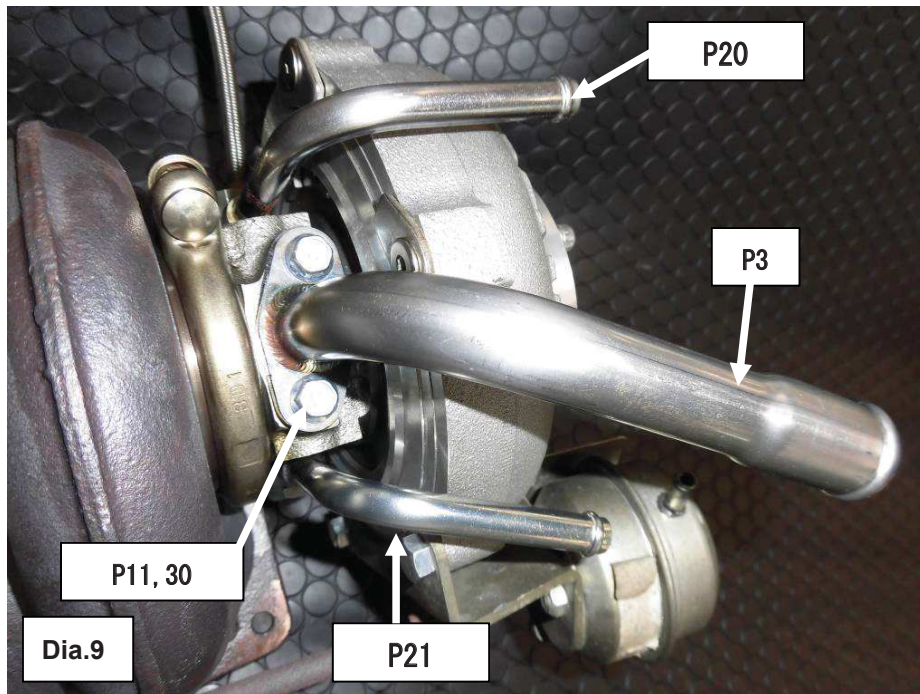

- P3 Oil Outlet Pipe x 1
- P11 Hexagon Bolt M6 L=15 x 2
- P30 Oil Outlet Pipe Gasket x 1

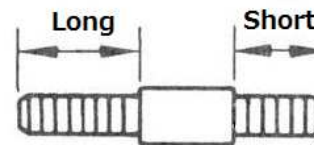

- (9) Install the Stud Bolts (P4 and P6) to the Turbocharger Assembly as shown in Diagram 10.

NOTE ※The shorter threaded portion must be installed to the turbocharger side.

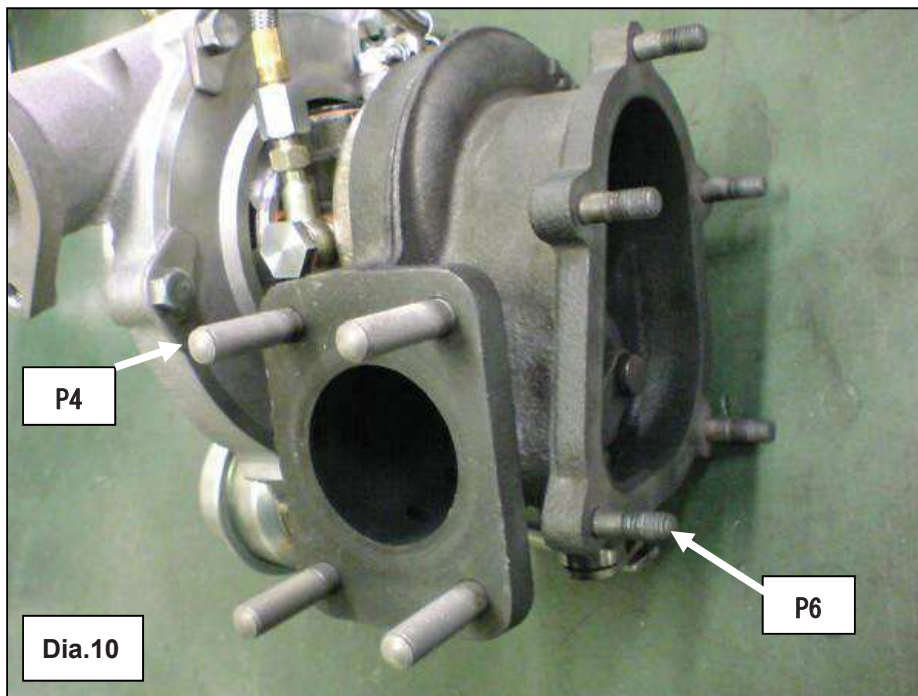

- P4 Stud Bolt M10 10-7-25 x 4
- P6 Stud Bolt M8 7-10-14 x 5

(10) Insert the Turbine Outlet Gasket (P31) between the Extension (P2) and the Turbocharger Assembly. Install the Extension using the Self-lock Nut M8 (P10) as shown in Diagram 11.

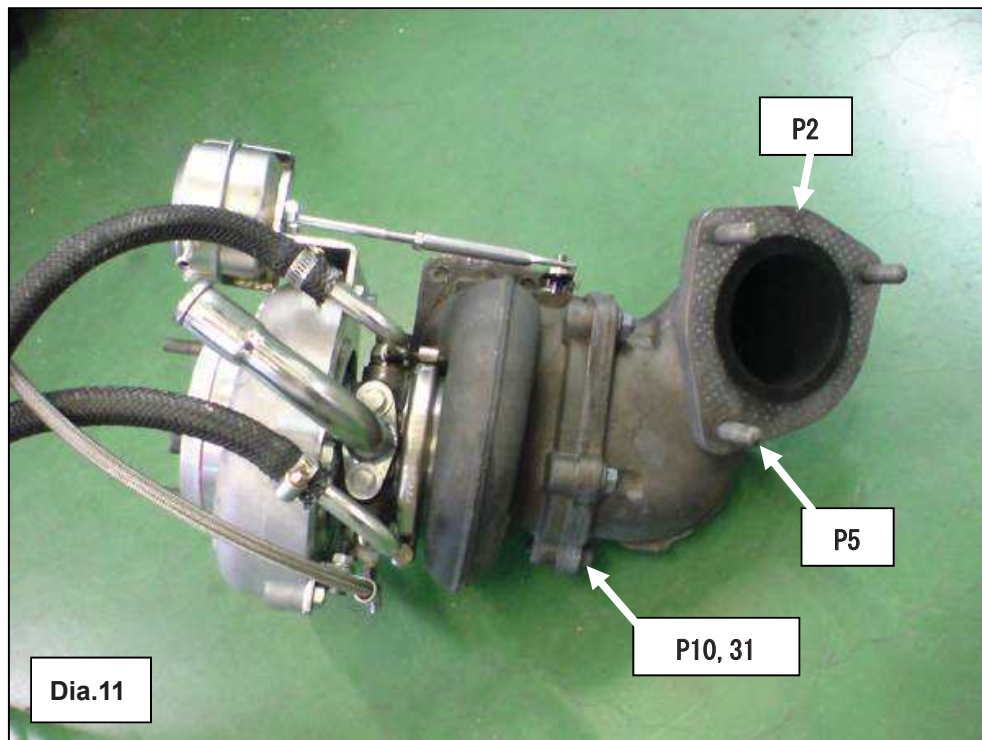

- P2 Extension x 1
- P10 Self-lock Nut M8 x 5
- P31 Turbine Outlet Gasket x 1

(11) Install the Stud Bolts (P5) to the Extension as shown in Diagram 11.

- P5 Stud Bolt M10 10-6-20 x 3

(12) Install the Stud Bolt (P6) to the intake flange of the Turbocharger's compressor as shown in the diagram below.

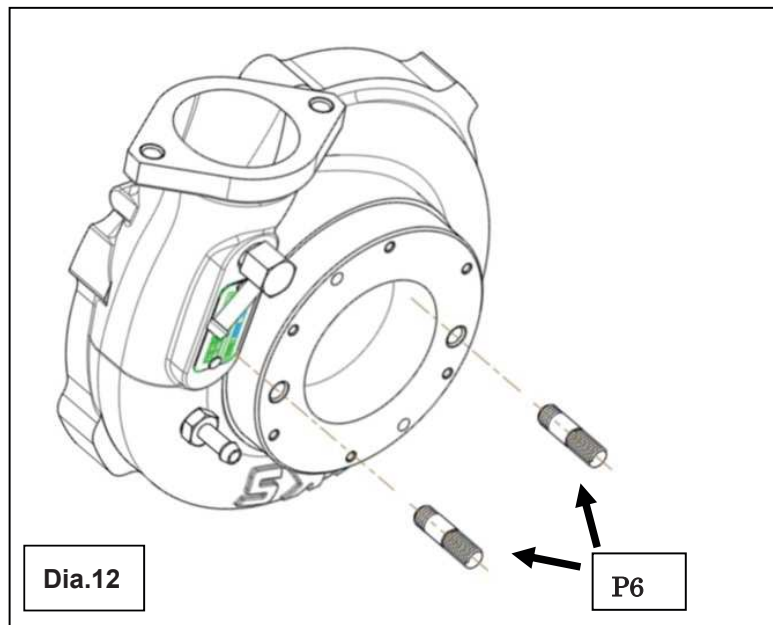

- P6 Stud Bolt M8 7-10-14 x 2

※If the 100mm Suction Adapter (P35) is required to be installed, skip (12) and proceed to (13).

(13) Install the 100mm Suction Adapter (P35) to the intake flange of the Turbocharger's compressor using the provided parts (P36, P37, and P38) as shown in Diagram 13.

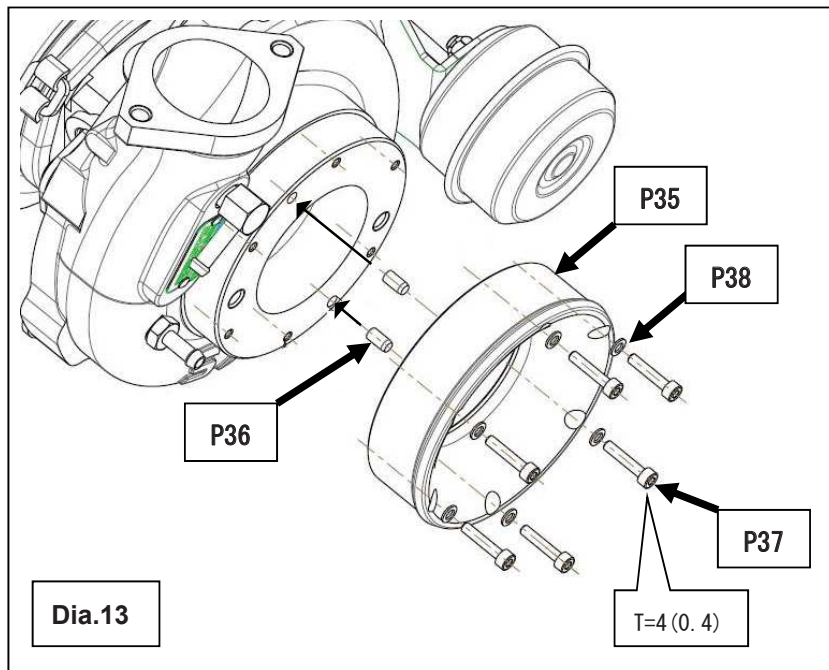

- P35 100mm Suction Adapter x 1
- P36 Pin x 2
- P37 Hexagon Socket Head Cap Bolt x 6
- P38 Spring Washer M4 x 6

(14) Place the Turbocharger Assembly to the position shown in Diagram 14.

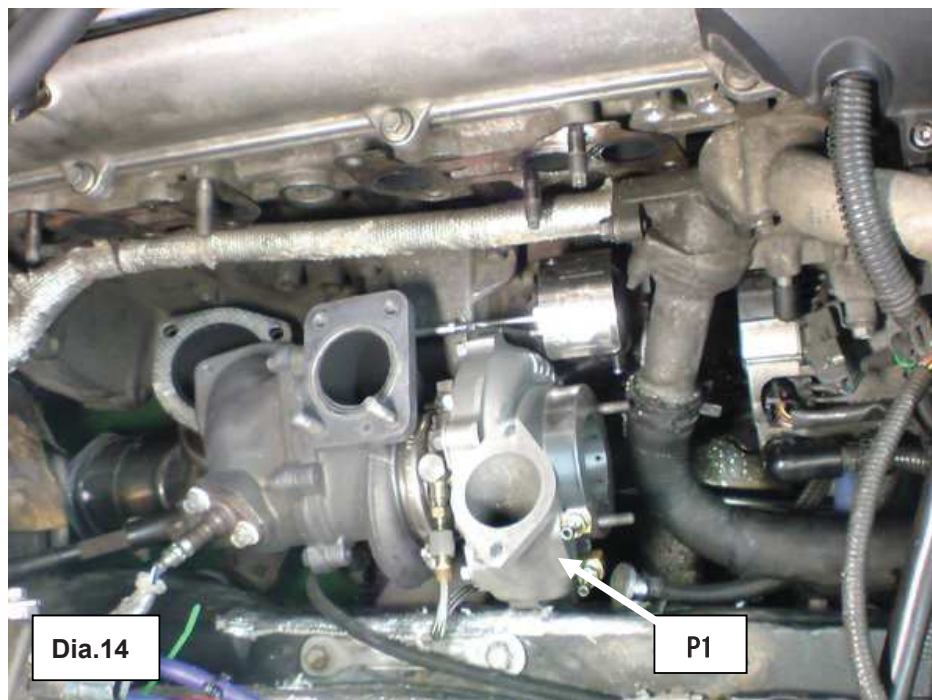

(15) Temporarily reinstall the exhaust manifold to the engine. Install the Turbocharger Assembly, and make sure it does not come in contact with the engine mount. Install the catalyzer, and make sure its position is not misaligned. If necessary, loosen the nuts of the Turbocharger, and adjust the position. Also, to eliminate unnecessary contact, shave a portion of the engine mount after removing the Turbocharger and/or exhaust manifold.



CAUTION

As shown in Diagram 15, the oil return pipe and water pipe are very close to the engine mount. Make sure they don't come in contact with the engine mount. If neglected, leakage of water and/or oil may be caused resulting in a damage of the engine.

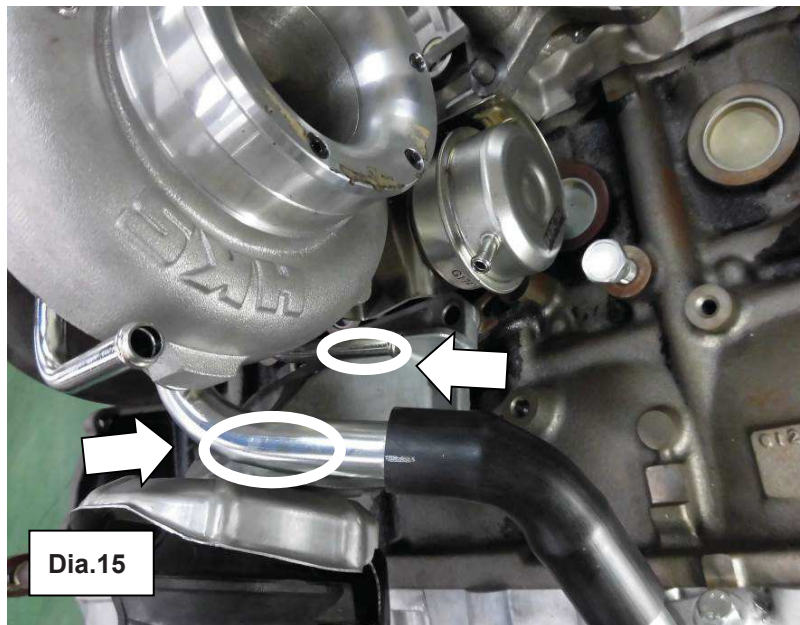

- (16) Remove the catalyzer and Turbocharger Assembly from the exhaust manifold, and install the Exhaust Manifold Outlet Gasket (P28).

- P28 Exhaust Manifold Outlet Gasket x 1

- (17) Install the exhaust manifold to the engine using the factory bolts and nuts.

- (18) Install the Turbocharger Assembly to the exhaust manifold using the factory nuts.

NOTE ※Make sure the oil return pipe and water pipe don't come in contact with any other part of the vehicle.

- (19) Install the O2 Sensor (P29) to the Extension using the following provided parts.

- P7 Flat Washer M8 x 2
- P8 Spring Washer M8 x 2
- P9 Hexagon Bolt M8 L=20 x 2

- (20) Connect the Oil Inlet Hose from the Turbocharger Assembly to the Oil Line Adapter (P16) installed to the cylinder block in 2.(1) as shown in Diagram 16.



CAUTION

When installing the Oil Inlet Hose, do not use a sealing tape and/or liquid gasket. These materials may be clogged resulting in a damage of the Turbocharger Assembly.

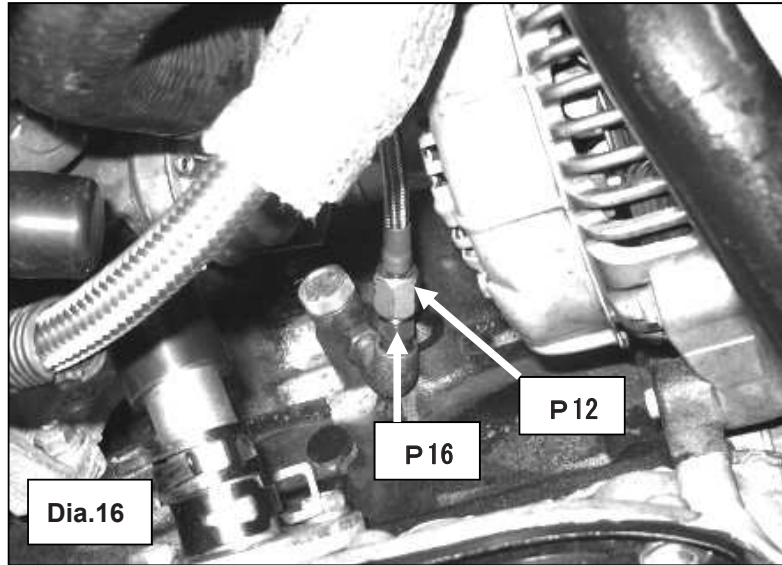

(21) Secure the Oil Inlet Hose with the provided Tie Wraps so it does not come in contact with high temperature parts such as exhaust parts. Wrap the provided corrugated tube around the parts that may come in contact with the body, wire, hose, etc. to protect those parts.

- P32 Corrugated Tube x 1
- P33 Tie Wrap (L) x 2
- P34 Tie Wrap (M) x 2

(22) Connect the Turbocharger Oil Outlet Pipe to the oil return pipe of the cylinder block using the factory oil outlet hose and hose clip.

NOTE

For JZX110 and JZS171, Toyota genuine turbo outlet hose is required to connect the pipes.
(15491-88410: Turbo Outlet Hose)

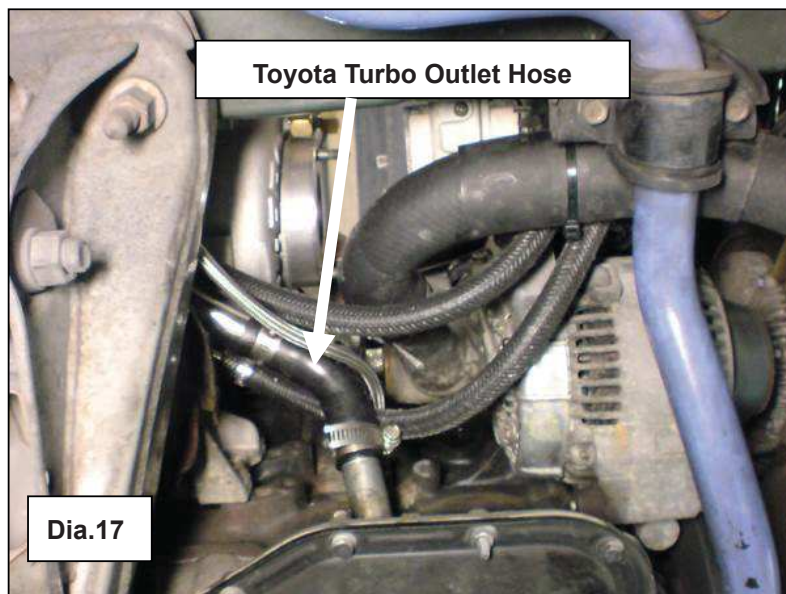

- (23) Connect the Water Hose A to the pipe connected to the water hose No.1 (13 in Dia.1), and Water Hose B to the pipe connected to the water hose No.2 (14 in Dia.1) using the provided Hose Band #4. (Refer to Dia.1 and Dia.18)

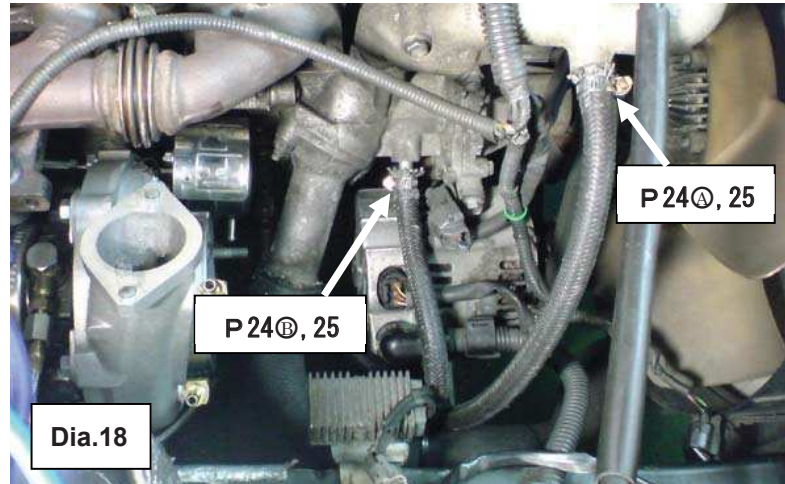

- P25 Hose Band #4 x 2

- (24) Secure the Water Hoses to the radiator hose using the provided Tie Wraps so it does not come in contact with any other parts of the vehicle.

- P33 Tie Wrap (L) x 1
- P34 Tie Wrap (M) x 1

- (25) Cut off the shaded portion of the heat insulator so it does not come in contact with the Turbocharger.

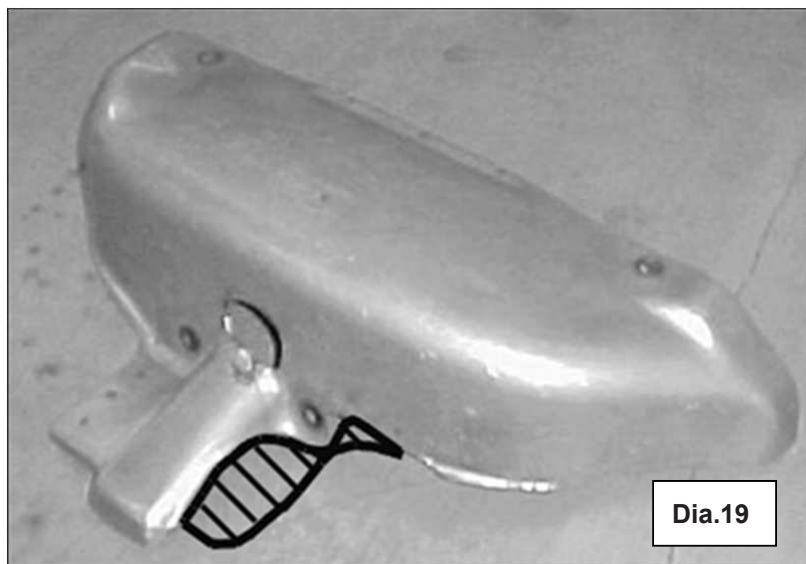

3. REINSTALLATION OF FACTORY PARTS

- (1) Reinstall the removed factory parts “1” to “3” and “6” to 12”using the opposite of the removal procedures.
- (2) Reinstall the removed undercover.
- (3) Refill the coolant and bleed the air out.
- (4) Refill the engine oil.
- (5) Reconnect the negative cable to the battery.

4. CONFIRMATION AFTER INSTALLTION

- (1) After the installation process is complete, check all items listed in the “Confirmation after Installation” section of the Instruction Manual.
- (2) Resetting of fuel and ignition using HKS F-Con or a similar device are required due to the engine output increase. Upgrade the fuel pump and/or injector’s capacity if necessary.
- (3) Check the spark plugs’ condition regularity and replace them if necessary.
- (4) Make sure the boost pressure is set to 78.4 to 88.2kPa (0.8-0.9kgf/cm²) using a meter. The boost pressure may slightly vary depending on the vehicle’s specification(s) and/or the other products installed on the vehicle.
- (5) Oil may leak from the turbocharger causing white smoke from the exhaust system if the oil pressure from the engine is too high or depending on the driving environment.
In this case, the oil volume may be improper due to the specification difference(s).
Excessive white smoke from the exhaust system continues even after performing running-in after the turbocharger is replaced, replace P18 Oil Inlet Banjo Bolt (With no letter in the hex part.) with P15 Oil Inlet Banjo Bolt with Orifice (“I” in the hex part) referring to 2 (5) on page 8.



HKS Co., Ltd.

7181 Kitayama, Fujinomiya, Shizuoka 418-0192, JAPAN

<http://www.hks-power.co.jp/>