

# GTⅢ SINGLE FULL TURBINE KIT TURBO LESS KIT INSTALLATION MANUAL



**Installation must be done by a professional.**

**Read this manual prior to the installation.**

Always have access to this manual as well as a factory service manual.

※ Make sure the vehicle is applicable to this kit.

NAME OF PRODUCT	GTⅢ SINGLE FULL TURBINE KIT / TURBO LESS KIT
PART NUMBER	11003-AN018 / 14020-AN012
APPLICATION	NISSAN SILVIA S14 • S15
ENGINE	SR20DET
YEAR	<ul style="list-style-type: none"> <li>• 1993/10–1996/09</li> <li>• 1996/06-1998/12(ABS fitted vehicle)</li> <li>• 1999/01-2002/08</li> </ul>
REMARKS	<p><b>【NOTE】</b></p> <ul style="list-style-type: none"> <li>● This product is for competition only. It cannot be used on general public roads.</li> <li>● After installation, be sure to reset the fuel and ignition system.</li> <li>● This product does not include a suction pipe and an air cleaner, so be sure to prepare it separately.</li> <li>● This product does not contain any heat shields and heat insulators, so please prepare separately.</li> <li>● This product is exclusively for vehicles equipped with a pre-installed inter cooler kit. (13001-AN006,13001-AN011,13001-AN012)</li> </ul>

## REVISION OF MANUAL

Rev. Number	Date	Manual Number	Details
3-3.01	2019/08	E04211-N37190-00	1st Edition
3-3.02	2020/08	E04211-N37191-00	Parts List revised. Instruction revised.
3-3.03	2020/09	E04211-N37192-00	Parts List revised. Instruction revised.

## CONTENTS

NOTICE / ATENTION / SAFETY PRECAUTIONS .....	1
PARTS LIST .....	2
1. REMOVAL OF NOMAL PARTS .....	5
2. MODIFY AND REARRANGEMENT OF NORMAL PARTS .....	6
3. KIT PARTS INSTALLATION .....	8
4. INSTALLATION OF NORMAL PARTS .....	20
5. BOOST SETTING .....	21

## NOTICE

This manual assumes that you have and know how to use the tools and equipment necessary to safely perform service operations on your vehicle. This manual assumes that you are familiar with typical automotive systems and basic service and repair procedures. Do not attempt to carry out the operations shown in this manual unless these assumptions are correct. Always have access to a factory repair manual. To avoid injury, follow the safety precautions contained in the factory repair manual.

## ATTENTION

- This manual indicates items you need to pay attention to in order to install this product safely and lists precautions to avoid any possible damage and/or accidents.
- This product is an automobile part. Do not use for any other purposes.
- HKS will not be responsible for any damage caused by incorrect installation and/or use, or use after modification and/or dismantling of this product.
- This product was designed based on installation onto a specific factory vehicle.
- The specifications of this product are subject to change without notice.
- The instructions are subject to change without notice. Make sure to refer to the most recent instructions.

## SAFETY PRECAUTIONS

The following precautions for use of this product are to prevent possible accidents and/or injuries and for proper use.















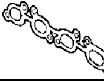







**WARNING** Indicates risk of serious injury and/or possible death.























**CAUTION** Indicates risk of damage to people or large-scale damage to property.  
(Large-scale damage is the damage caused by a product defect.  
Ex. Damage to a vehicle, burnout, etc.)









# PARTS LIST

NO.	DESCRIPTIONS	QTY	IMAGE	REMARKS
1	GTIII-RS Turbocharger Assembly	1		Only For 11003-AN018
2	Exhaust Manifold	1		
3	Extension (Turbo Outlet)	1		
4	O <sub>2</sub> Sensor Plug Bolt	1		
5	Gasket Exhaust Manifold	1		
6	Gasket T-25 Turbocharger Flange	1		
7	Gasket Turbocharger Outlet	1		
8	Stud Bolt M8-1.25 13-9-16	8		
9	Self-lock Nut M8-1.25	8		
10	Gasket Front Pipe $\phi$ 70 Tri	1		
11	Gasket Bypass Outlet	1		
12	Stud Bolt M10-1.25 10-7-28	3		
13	Wastegate Outlet Pipe	1		
14	Wastegate	1		
15	Base Bypass	1		
16	Gasket Base Bypass	1		
17	Cap Bolt M6-1.0 L=16	1		For Wastegate
18	Cap Bolt M6-1.0 L=20	3		For Wastegate
19	Hose Clamp $\phi$ 6	4		For Wastegate
20	Oil Resistant Hose $\phi$ 6 L=2000	1		For Wastegate

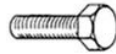
## PARTS LIST

NO.	DESCRIPTIONS	QTY	IMAGE	REMARKS
21	PT Elbow	2		For Wastegate
22	Water Plug $\phi 6$	3		For Wastegate $\times 2$ For Chamber pipe $\times 1$
23	Chamber Pipe	1		
24	Silicon Hose $\phi 50\text{-}\phi 60$ L=70	1		
25	Silicon Hose $\phi 50$ L=70	1		
26	Horse Band #36	4		
27	Inlet Banjo	1		Turbocharger Oil Line
28	Banjo Bolt M12-1.25	1		Turbocharger Oil Line
29	Copper Washer $\phi 12$	3		For Banjo $\times 2$ For Engine Block $\times 1$
30	Inlet Hose L=600	1		
31	Nipple Oil Line	1		
32	Bolt Oil Inlet Hose	1		For Engine Block
33	Oil Outlet Pipe	1		
34	Gasket Oil Outlet	1		
35	Water Resistant Hose $8\phi$ L=1500 mm	1		Water Line
36	Hose Nipple M14- $\phi 8$	1		Water Line
37	Banjo Bolt M14-1.5	3		Water Line
38	Banjo Pipe	3		Water Line
39	Copper Washer $\phi 14$	7		For Water Line
40	Horse Band #4	4		

## PARTS LIST

NO.	DESCRIPTIONS	QTY	IMAGE	REMARKS
41	Power Steering Pipe	1		
42	Air Conditioner Hose Stay	1		
43	Flange Nut M8-1.25	1		
44	Bolt M8-1.25 L=20	3		
45	Plain Washer M8	3		
46	Spring Washer M8	3		
47	Flange Bolt M6-1.0 L=15	2		Oil Outlet Pipe
48	Tie Wrap Medium (L=150)	10		
49	Instruction Manual	1		General
50	Installation Manual	1		Full Turbine Kit

\* To purchase individual part, please contact the dealer.

# 1. REMOVAL OF FACTORY PARTS

Disconnect the negative cable from the battery terminal before installation.  
Use this instruction manual and the manufacturer's service manual as a reference.

- (1) Remove the undercover.
- (2) Drain the coolant.
- (3) Remove the front exhaust pipe.
- (4) Disconnect the airflow meter connector.
- (5) Disconnect the O<sub>2</sub> sensor coupler.
- (6) Remove the parts ① to ⑪.(Fig.1-6)

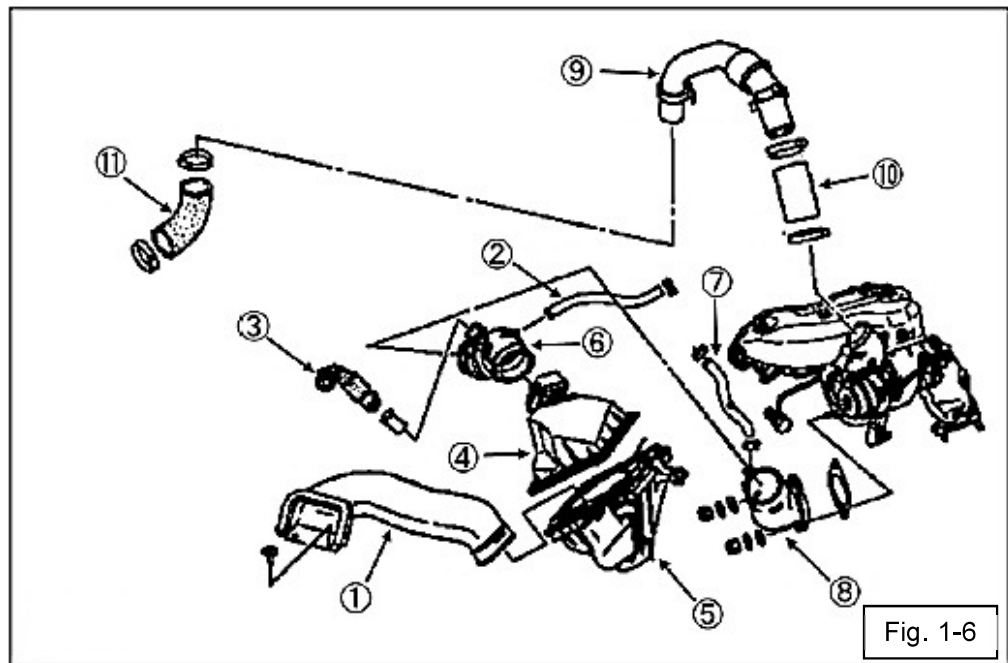

- (7) Remove the parts ① to ⑫.(Fig.1-7)

Use the O<sub>2</sub> sensor① again.

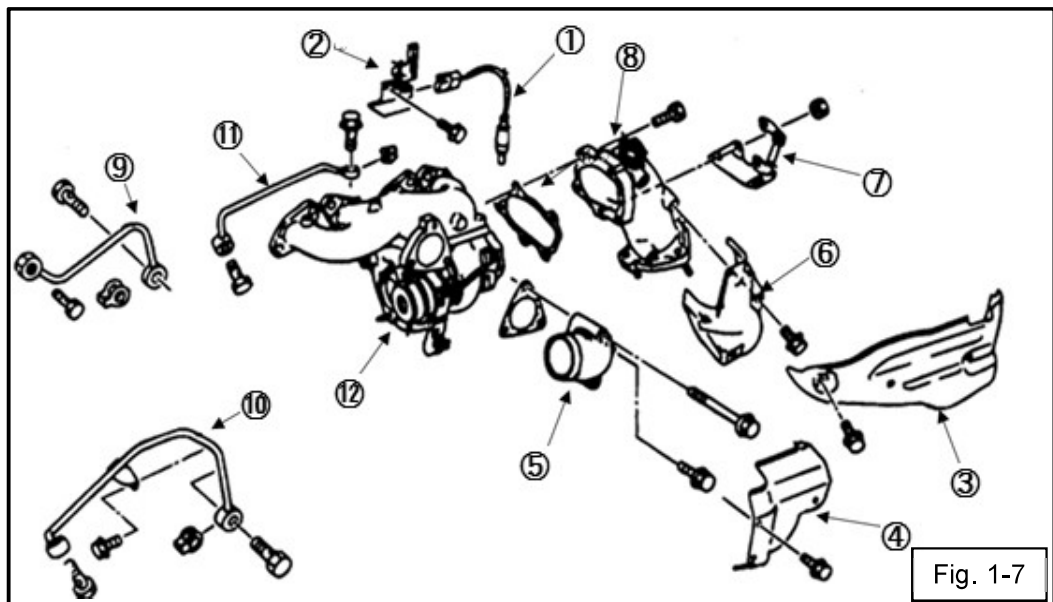

- (8) Remove the supercharging pressure control solenoid.

## 2. MODIFY AND REARRANGEMENT OF NORMAL PARTS

- (1) Remove the power steering fluid from the power steering tank.
- (2) Remove the hose A and B from the power steering tank. (Fig. 2-2)

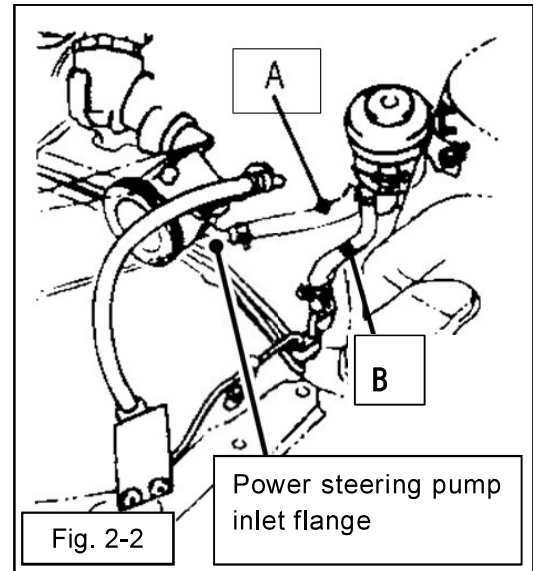

- (3) Place the hose B across over the air conditioner pipe. In this case, please reuse the normal hose band. (Fig. 2-3)

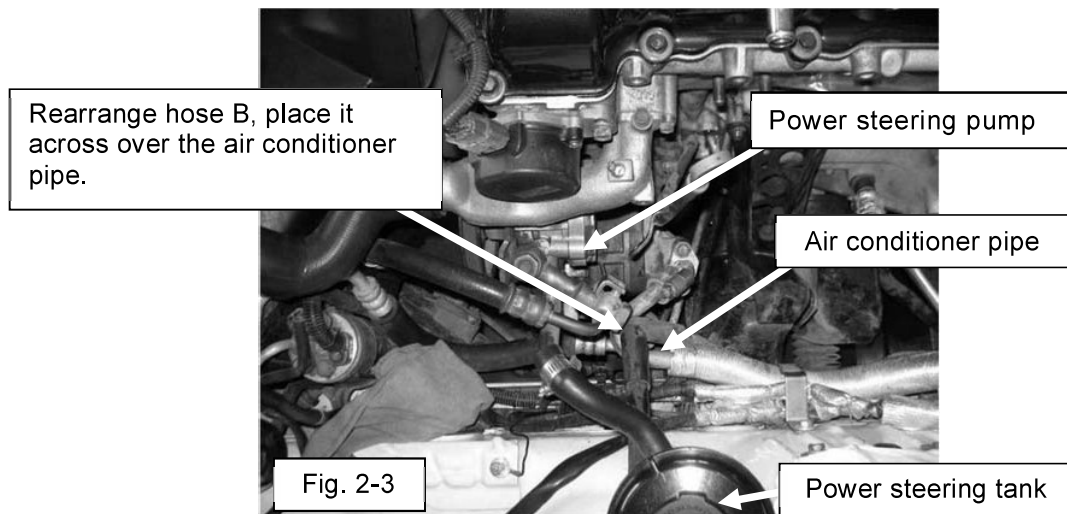

- (4) Cut the hose A removed in (2) as shown in the figure 2-4. (Fig. 2-4)

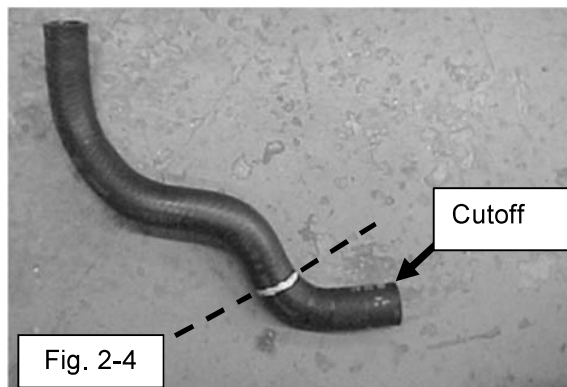

- (5) Remove the power steering pump inlet flange. (Fig. 2-2)
- (6) Install the supplied power steering pipe instead of the inlet flange removed in (5) using M8 bolts, plain washers and spring washers. (Fig. 2-7)

- (7) Connect the power steering pipe and the power steering tank using with the hose A which modified in 2-(4) and a normal hose band. (Fig. 2-7)

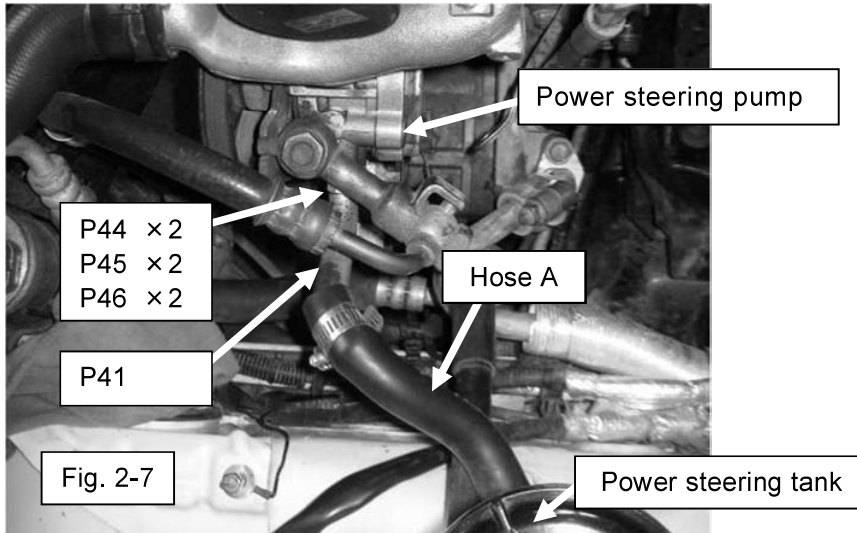

- (8) Preventing the heat to the air conditioner hose, heater hose, other hoses and harnesses by using with heat shield and/or heat insulator. (Note: Heat shield and Heat insulator is not included in this kit) (Fig. 2-8)

- (9) Remove the clip that holds the harness to the body. (Fig. 2-9-1)

Bend the air conditioner hose to the body side as figure 2-9-2.  
 Make sure that it does not interfere with the air conditioner hose when mounting the exhaust manifold. (Fig. 2-9-2)

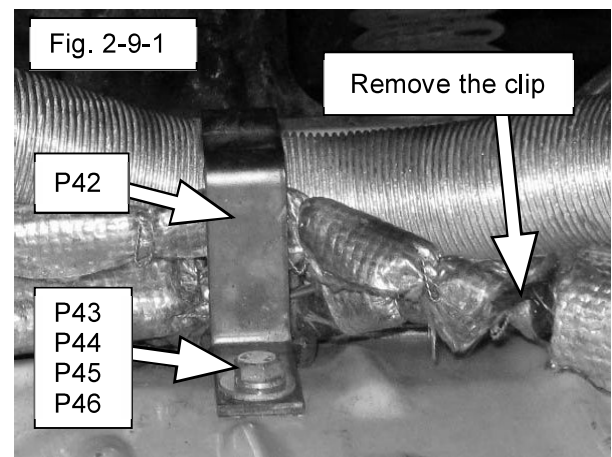
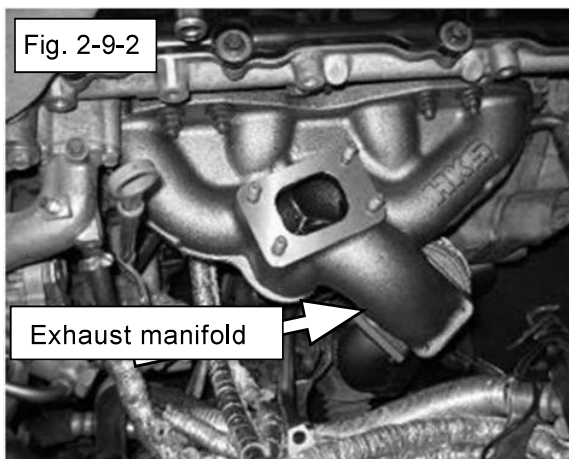
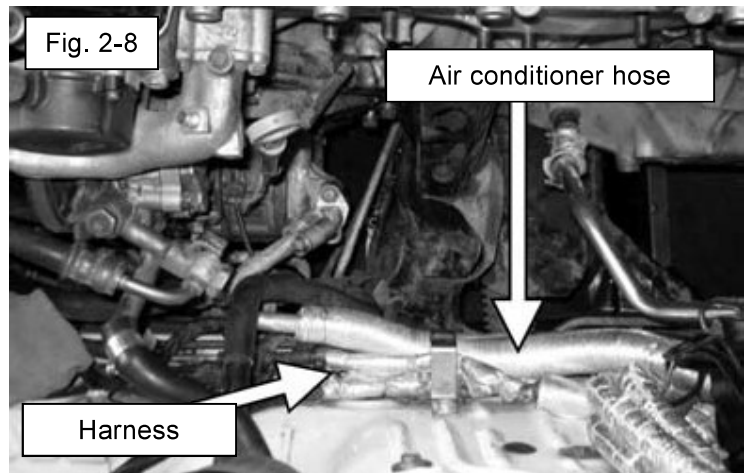

- (10) Attached the air conditioner hose stay to the hole which removed the clip in (9) using with M8 bolt, plain washer, spring washer, and flange nut. (Fig. 2-9-1)



- (11) When installing on S14, preventing the heat to the power transistor and the harness by using the heat shield materials. (Fig. 2-11)

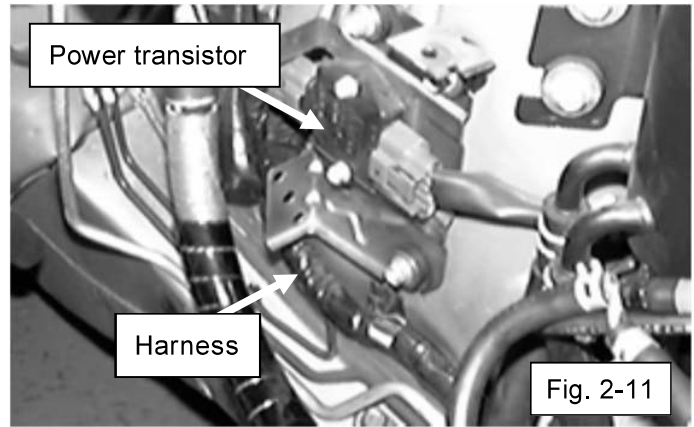

### 3. KIT PARTS INSTALLATION

- (1) Assemble the oil inlet hose. (Fig. 3-1)

#### CAUTION

Do not use sealing tape or liquid gasket when assembling the oil line.

Air blow the parts before assembly.

It may block the oil line of the turbocharger body and in the worst case it may damage the turbocharger.

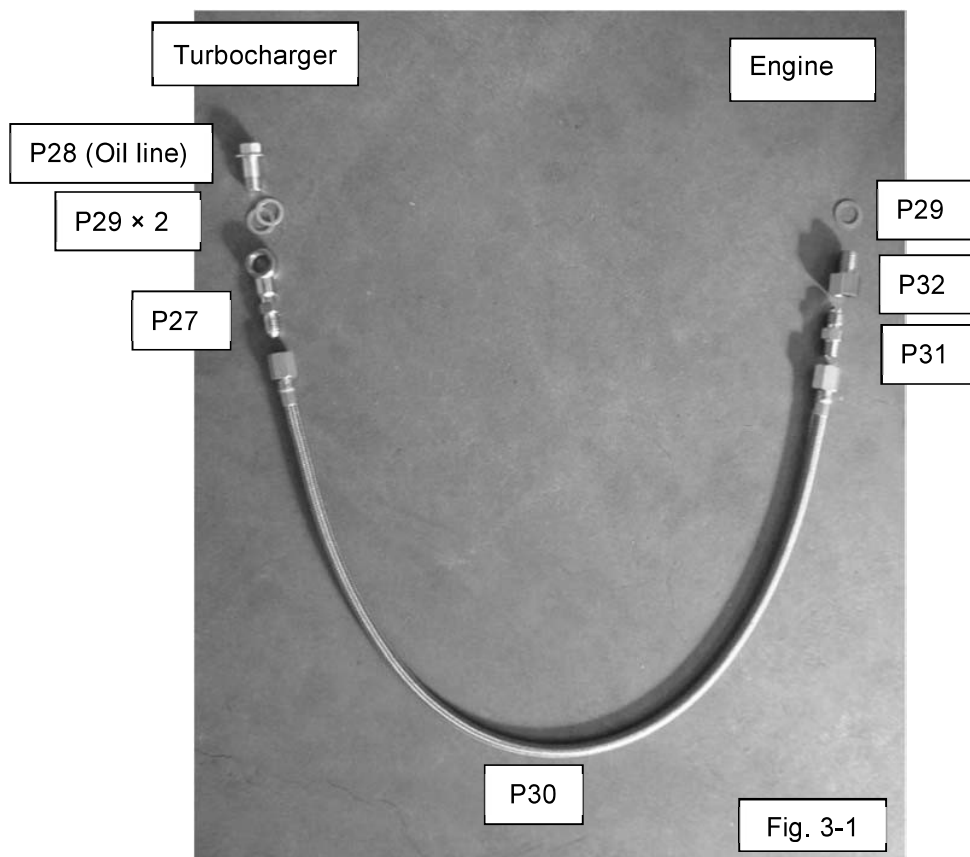

(2) Wrap a heat shield on the assembled oil inlet hose preventing the heat. (Fig. 3-2)

 **WARNING**

- Keep the oil line away from high temperature exhaust parts. If neglected, oil line may be damaged, and it may cause oil leakage; in the worst case, it may cause a vehicle fire.
- When securing the Oil Inlet Hose, make sure the hose is not subjected to unnecessary force, and the staked part of the Oil Inlet Hose is not bent tightly. If neglected, it may cause damage to the Oil Inlet Hose and oil leakage; in the worst case, it may cause a vehicle fire.

**Tightening Torque N·m {kgf·m}**

T= 11±1.7 {1.13±0.17}

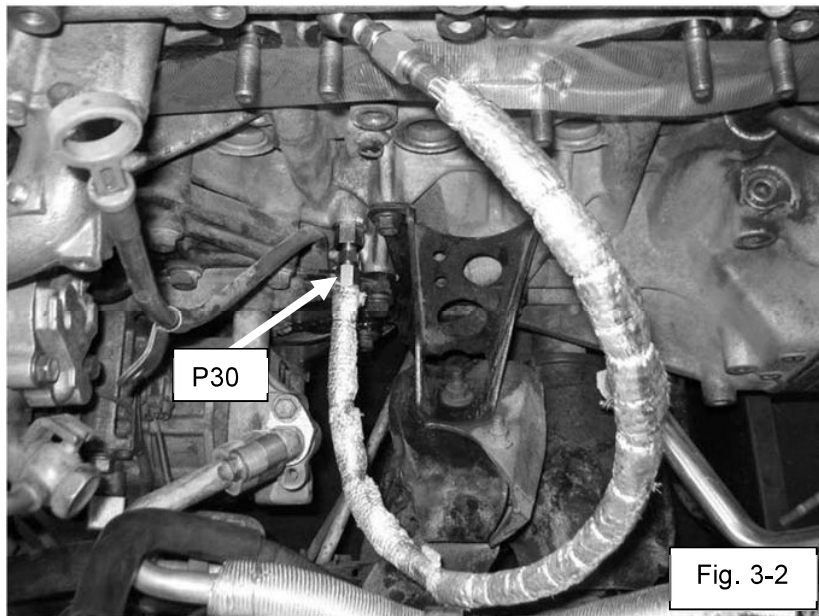

(3) Attach the oil outlet pipe to the engine using the factory hose and the factory band. (Fig. 3-3)

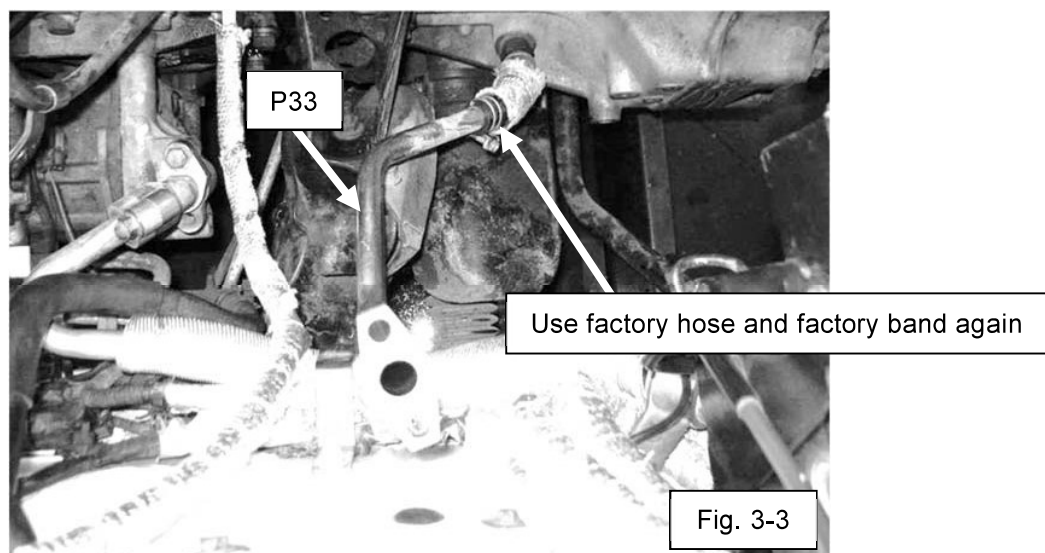

- (4) Assemble the water inlet hose. (Fig. 3-4)

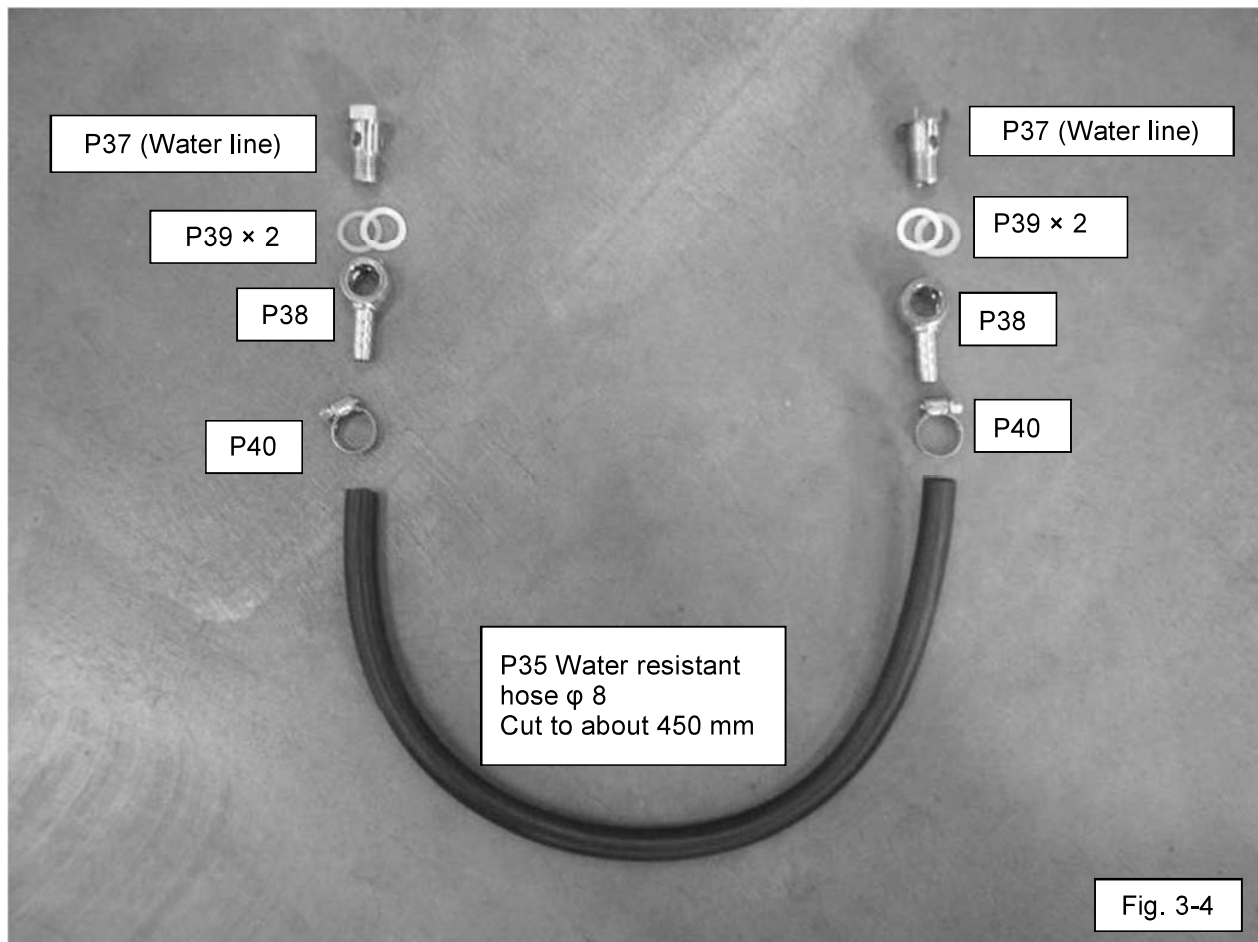

- (5) Wrap a heat shield on the assembled water inlet hose preventing the heat. (Fig. 3-5)

**Tightening Torque N·m {kgf·m}**

T= 36±5.4 {3.65±0.55}

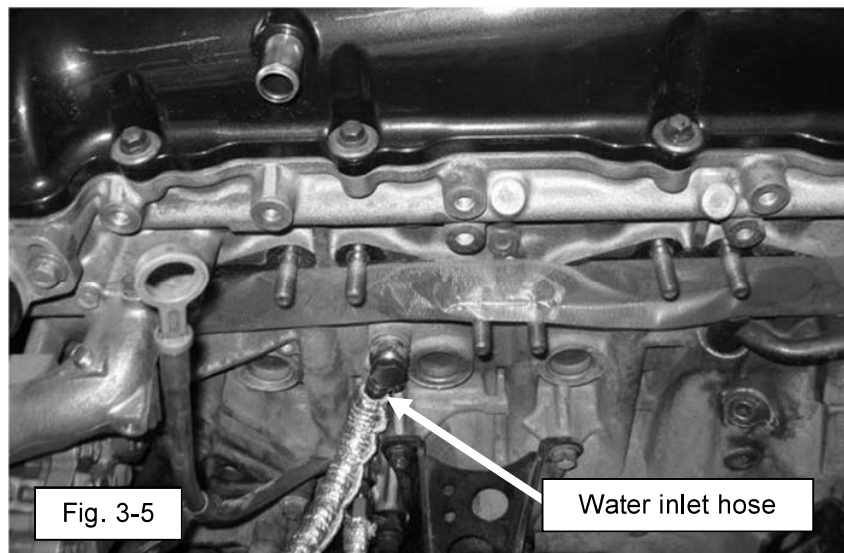

(6) Assemble the water outlet hose. (Fig. 3-6)

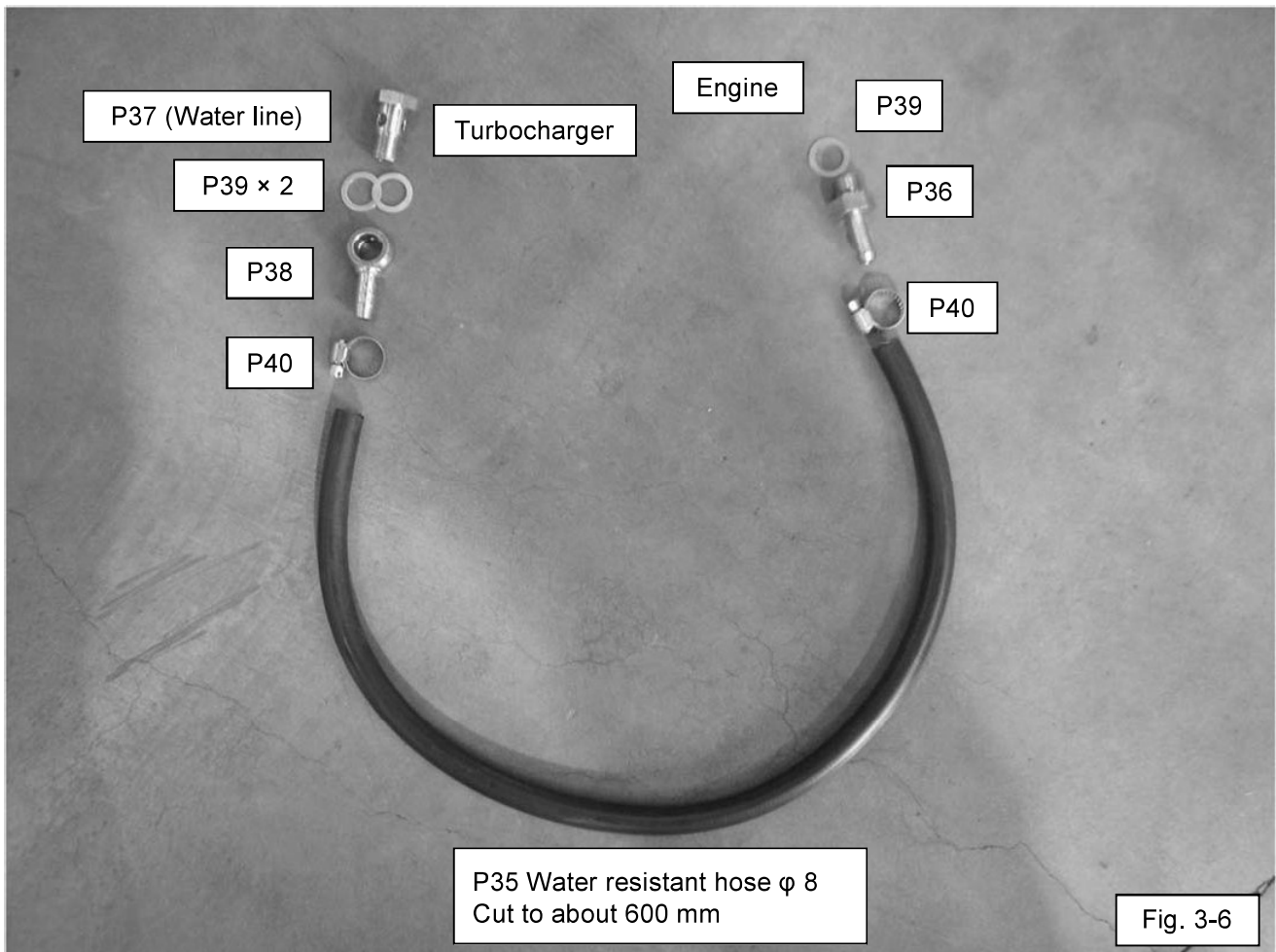

(7) Wrap a heat shield on the assembled water outlet hose preventing the heat. (Fig. 3-7-1 and 3-7-2)

**Tightening Torque N·m {kgf·m}**

T= 36±5.4 {3.65±0.55}

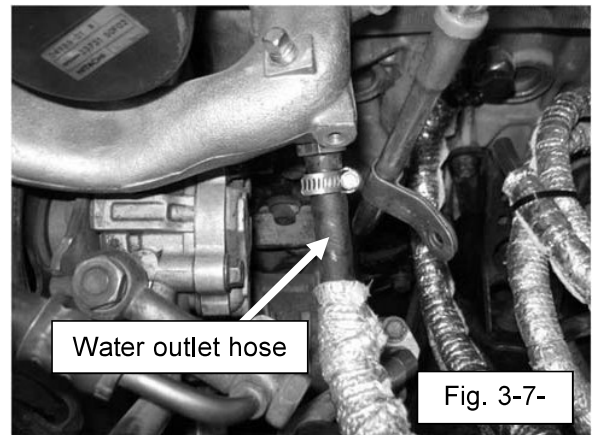
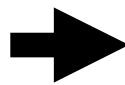
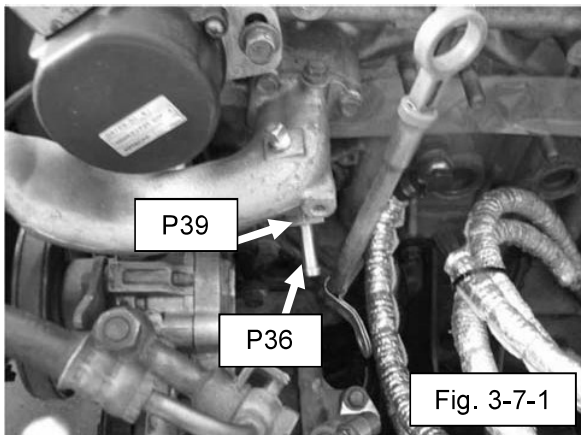

## <Overall configuration around turbocharger>

Fig. 3- Overall structure



(8) Install the M8 stud bolts on the exhaust manifold. (Fig. 3-8-1)

*Note: Attach the shorter thread of the stud bolt to the exhaust manifold.* (Fig.3-8-2)

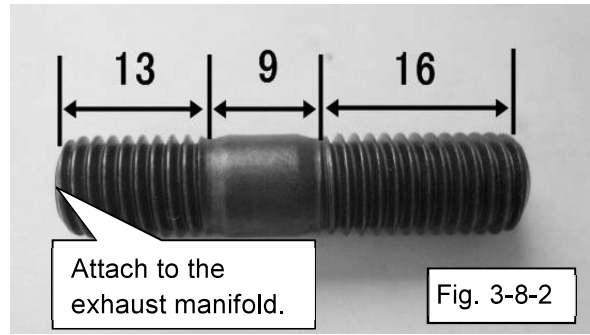
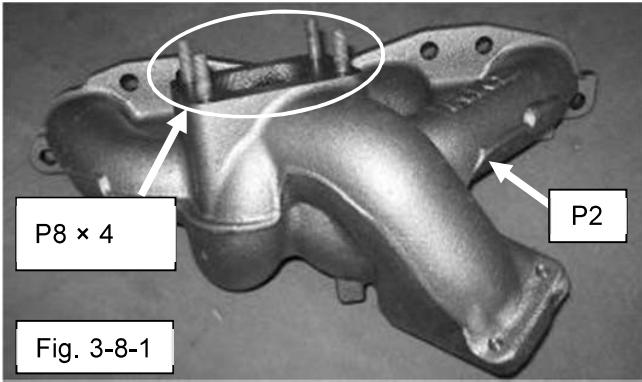

(9) Install the PT elbows and the  $\phi 6$  hose nipples on wastegate. (Fig. 3-9)

Apply sealing tape or liquid gasket to the thread of PT1/8 screw.

Liquid gasket: ThreeBond TB1207C

**Tightening torque: N·m{kgf·m}**

T=6.4±1.4 {0.65±0.15}

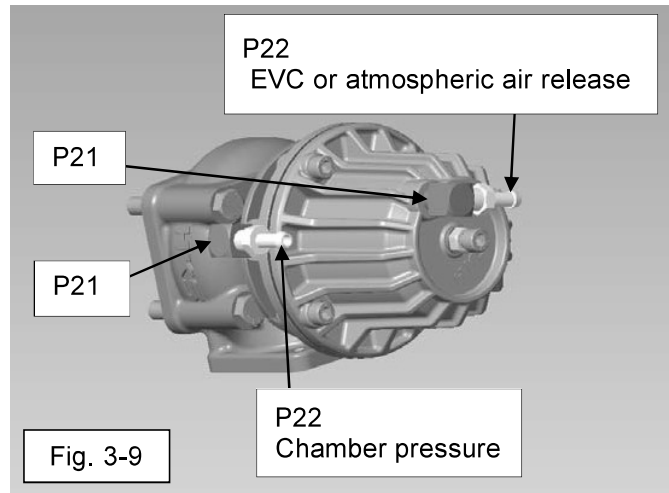

(10) Install the Wastegate on the exhaust manifold. (Fig. 3-10-1)

Meet each other.

*Note: each side has different width.*

(Fig. 3-10-2)

**Tightening Torque N·m {kgf·m}**

T= 16.2±3.2 {1.65±0.33}

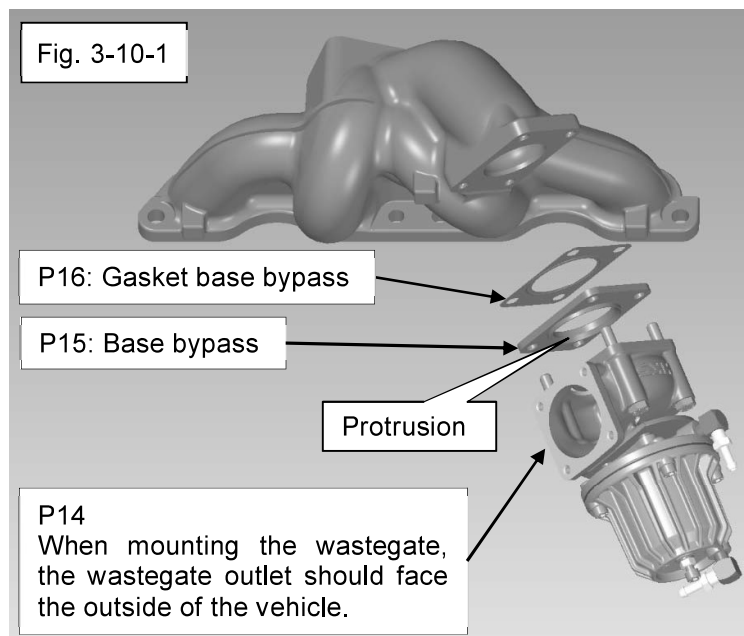
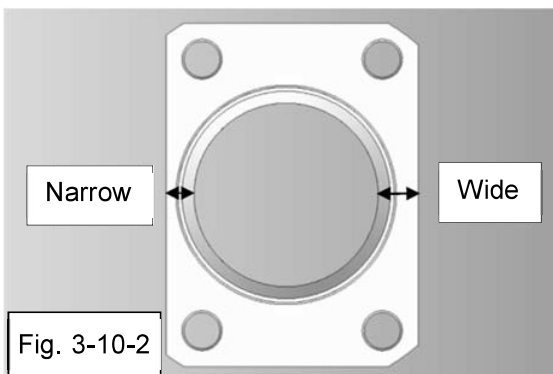

(11) Install the exhaust manifold on the engine. (Fig. 3-11-1 and 3-11-2)

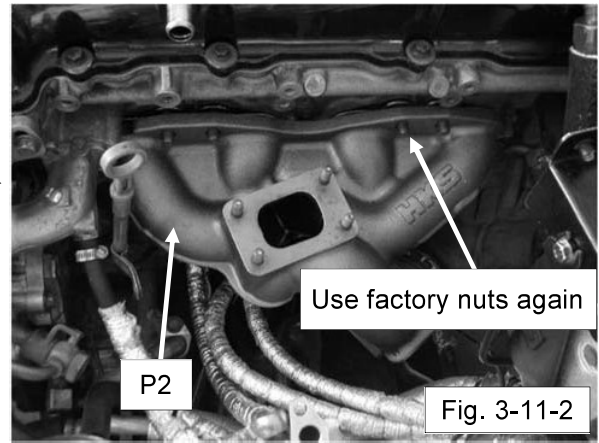
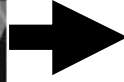
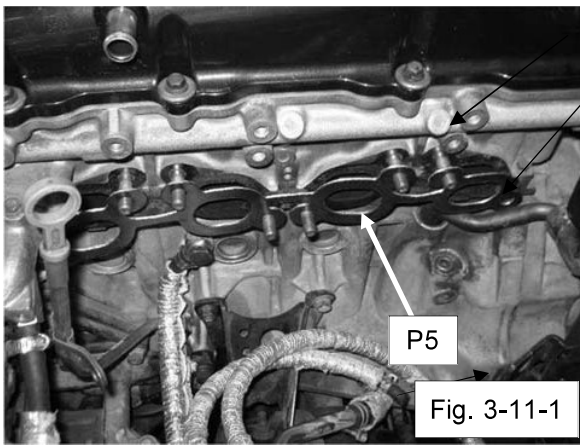

(12) Attach the wastegate outlet pipe to the wastegate. (Fig. 3-12-1 and 3-12-2)

**⚠ WARNING**

High heat exhaust gas discharged from the wastegate outlet pipe.  
Never place any flammable materials near the wastegate outlet pipe preventing the risk of fire.

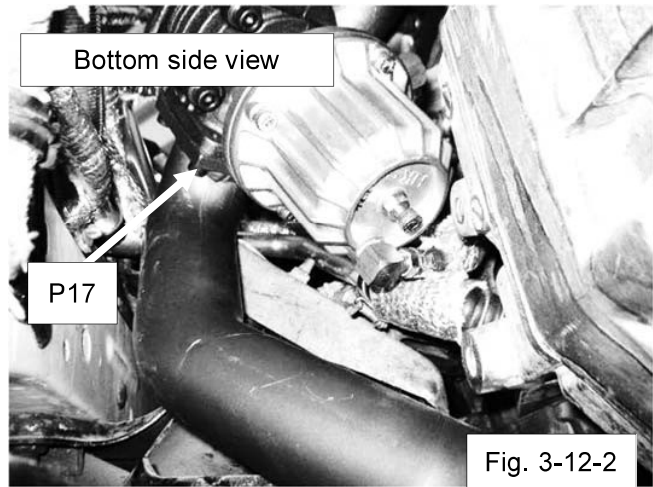
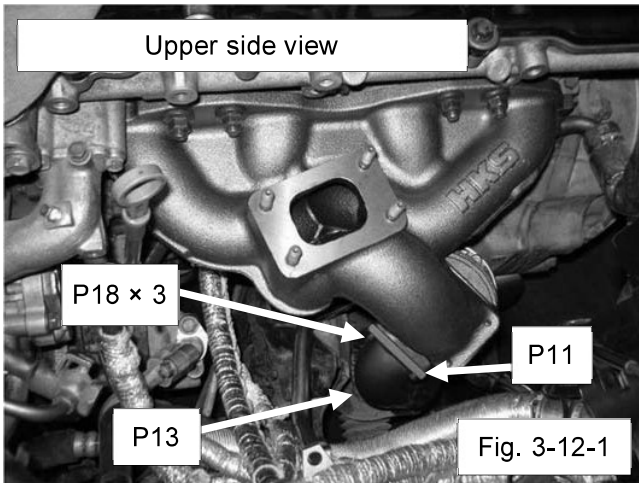

**Tightening Torque N·m {kgf·m}**

T= 7.7±1.5 {0.79±0.15}

(13) Tighten together with the wastegate outlet pipe stay and the extension outlet flange. 3-(22). (Fig. 3-13)

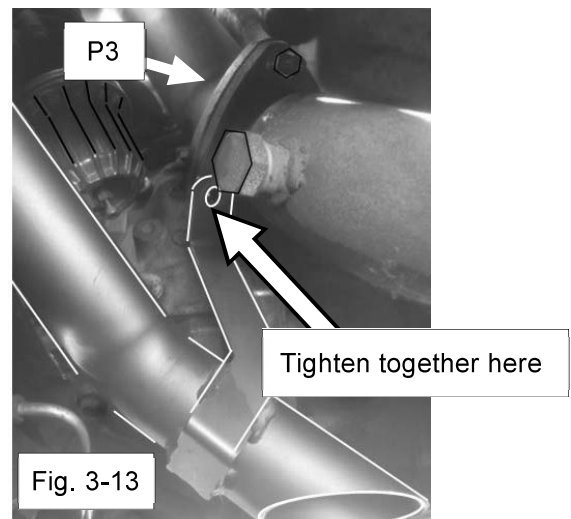

- (14) Attach the M8 stud bolts to the turbocharger body, and install a gasket T25 turbo flange on the exhaust manifold. (Fig. 3-14-1 and 3-14-2)

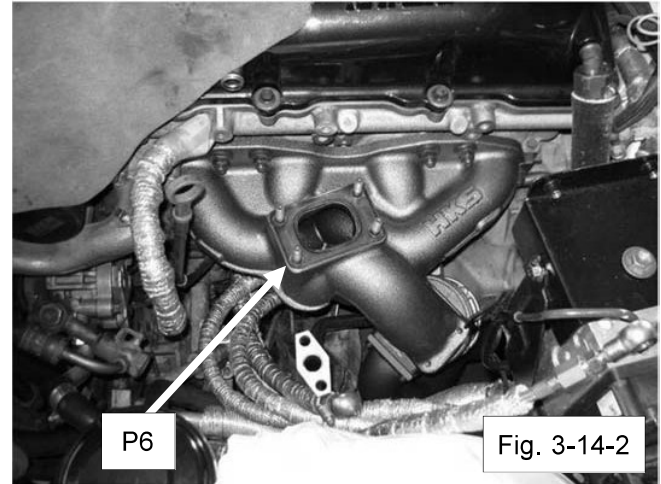
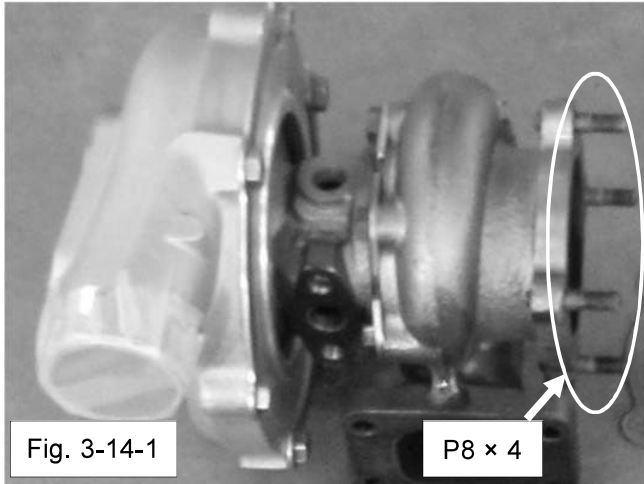

- (15) Install the turbocharger body on the exhaust manifold. (Fig. 3-15)

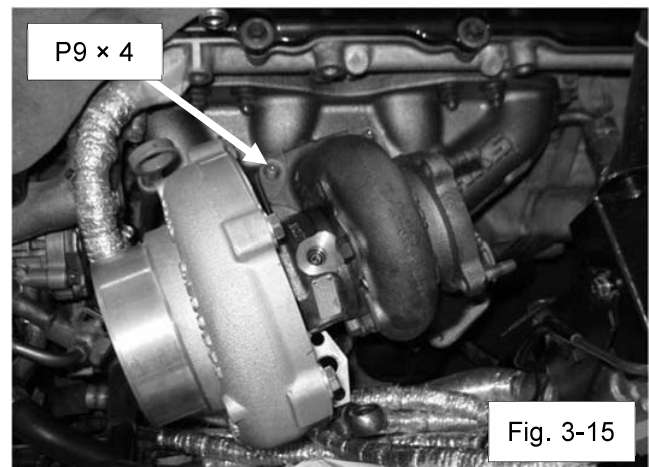

- (16) Loosen the V-band coupling holding the turbocharger exhaust housing and adjust the center housing angle. (Fig. 3-16)



## CAUTION

If the V-band is over-loosed, the turbine wheel will touch with the turbine housing. Make sure the turbine shaft rotates by hand.

After adjusting the angle, retighten as follows.

Applying anti-seizure agent to screw head. Tighten as specified torque.

Tap the coupling the circumference of the coupling gently, more than 3 times with plastic hammer.

Retighten as specified torque.

### **Tightening Torque N·m {kgf·m}**

M6 thread type:  $T= 8.3\pm 0.5$  { $0.85\pm 0.05$ }

M8 thread type:  $T=15.7\pm 1.0$  { $1.60\pm 0.10$ }



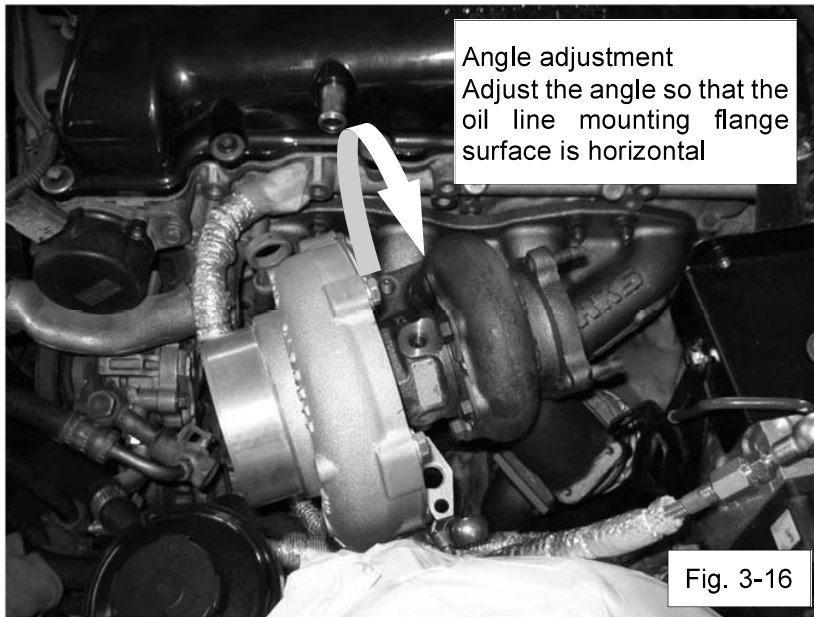

Fig. 3-16

(17) Attach the oil outlet pipe to the turbocharger body. (Fig. 3-17)

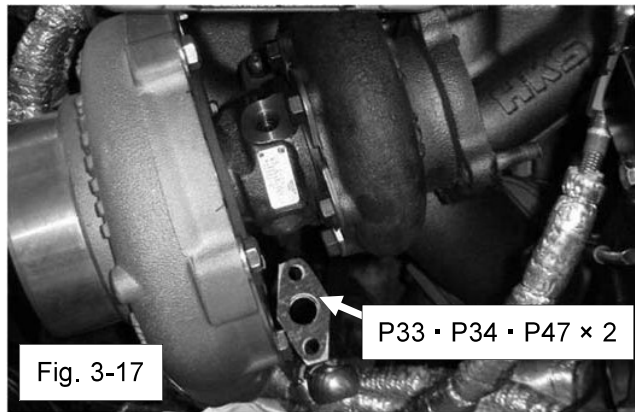

Fig. 3-17

(18) Attach the water inlet hose to the turbocharger body. (Fig. 3-18)

**Tightening Torque N·m {kgf·m}**

T= 36±5.4 {3.65±0.55}

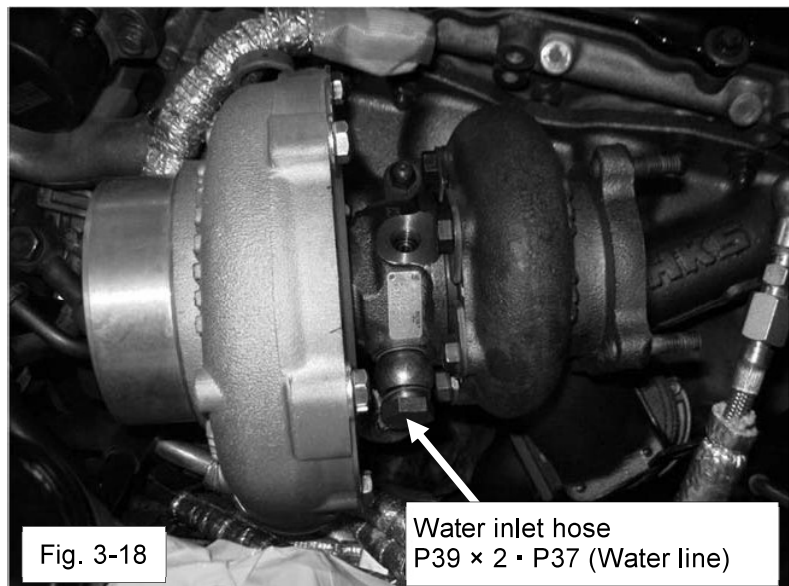

Fig. 3-18

(19) Attach the oil inlet hose to the turbocharger body. (Fig. 3-19)

 **WARNING**

- Keep the oil line away from high temperature exhaust parts. If neglected, oil line may be damaged, and it may cause oil leakage; in the worst case, it may cause a vehicle fire.
- When securing the Oil Inlet Hose, make sure the hose is not subjected to unnecessary force, and the staked part of the Oil Inlet Hose is not bent tightly. If neglected, it may cause damage to the Oil Inlet Hose and oil leakage; in the worst case, it may cause a vehicle fire.

• Inlet hose (P30)

**Tightening Torque N·m {kgf·m}**

T= 11±1.7 {1.13±0.17}

• Banjo Bolt (P28)

**Tightening Torque N·m {kgf·m}**

T= 24.5 ± 4.9 {2.5 ± 0.5}

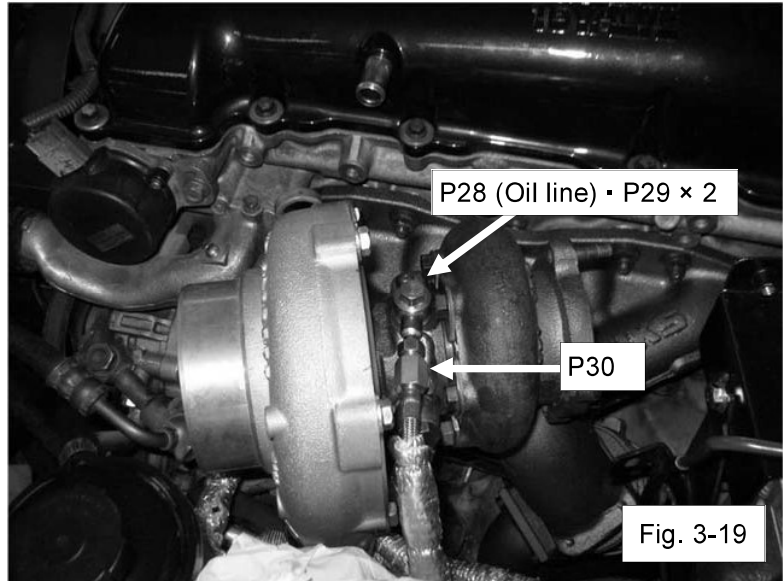

(20) Attach the water outlet hose to the turbocharger body. (Fig. 3-20)

**Tightening Torque N·m {kgf·m}**

T= 36±5.4 {3.65±0.55}

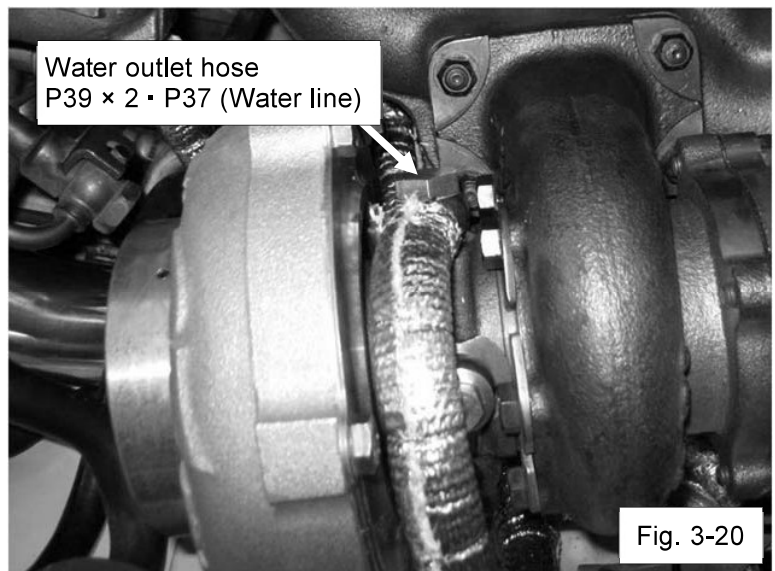

(21) Attach the M10 stud bolts and the O<sub>2</sub> sensor plug bolt to the extension (turbo outlet). (Fig. 3-21)

Note: Attach the shorter thread of the stud bolt to the extension.

- O<sub>2</sub> sensor plug bolt (P4)

**Tightening Torque N·m {kgf·m}**

T= 50 ± 10 {5.1 ± 1}

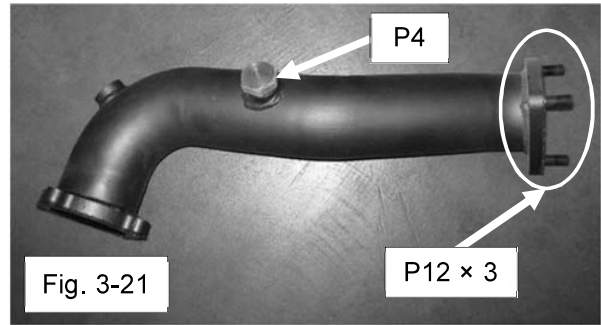

(22) Attach an extension (turbo outlet) to the turbocharger body. (Fig. 3-22-1 and 3-22-2)

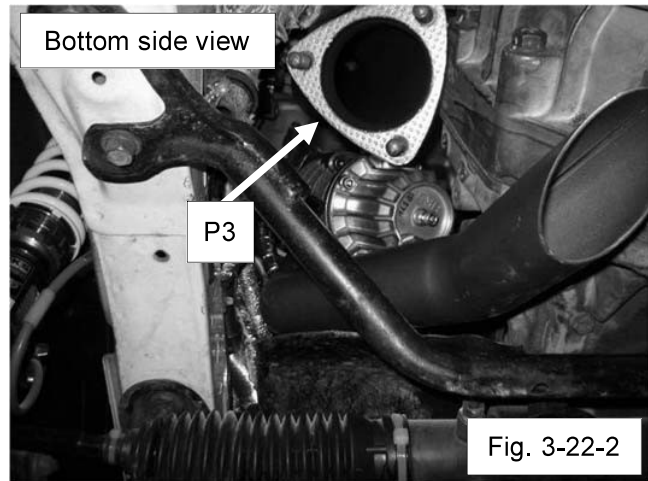
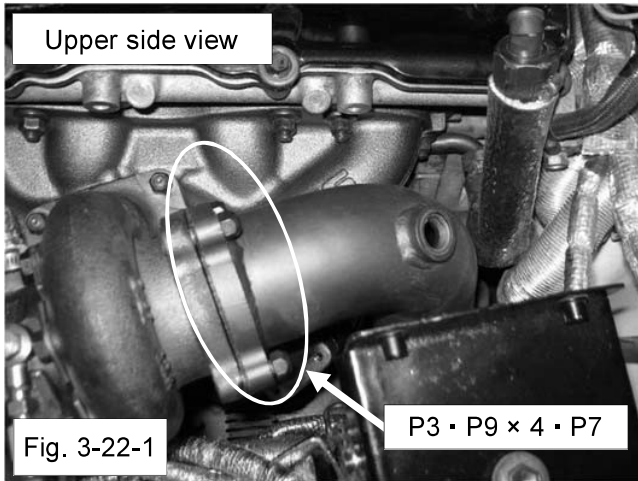

(23) Adjust the angle of the compressor housing with slightly loosen the bolts 6 pcs. (Fig. 3-23)

**CAUTION**

If the bolt is over-loosed, the compressor wheel will touch with the compressor housing. Make sure the turbine shaft rotates by hand.

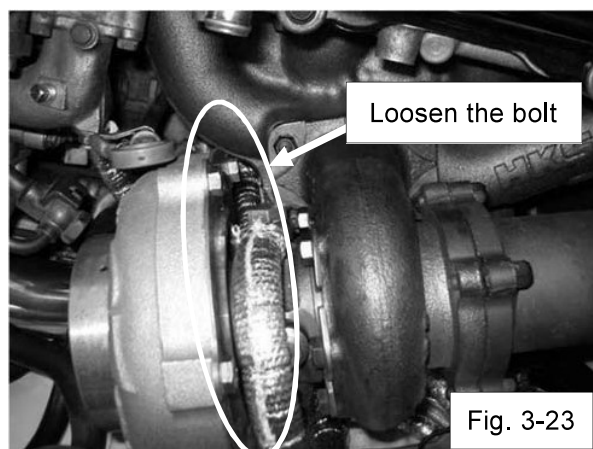

(24) Install and place the chamber pipe with rotating the compressor housing. (Fig. 3-24)

Note: As the fitting connection part of the chamber pipe and the compressor outlet may not be fitted. If not fitted, modify the chamber pipe and install the proper fitment.

Avoid to contact the chamber pipe and the power steering pipe/body, put the shock absorber material between them.

Retighten it after adjusting the angle. Refer to the below.

**Tightening Torque N·m {kgf·m}**

M8 thread: T=13.0±0.5 {1.30±0.05}

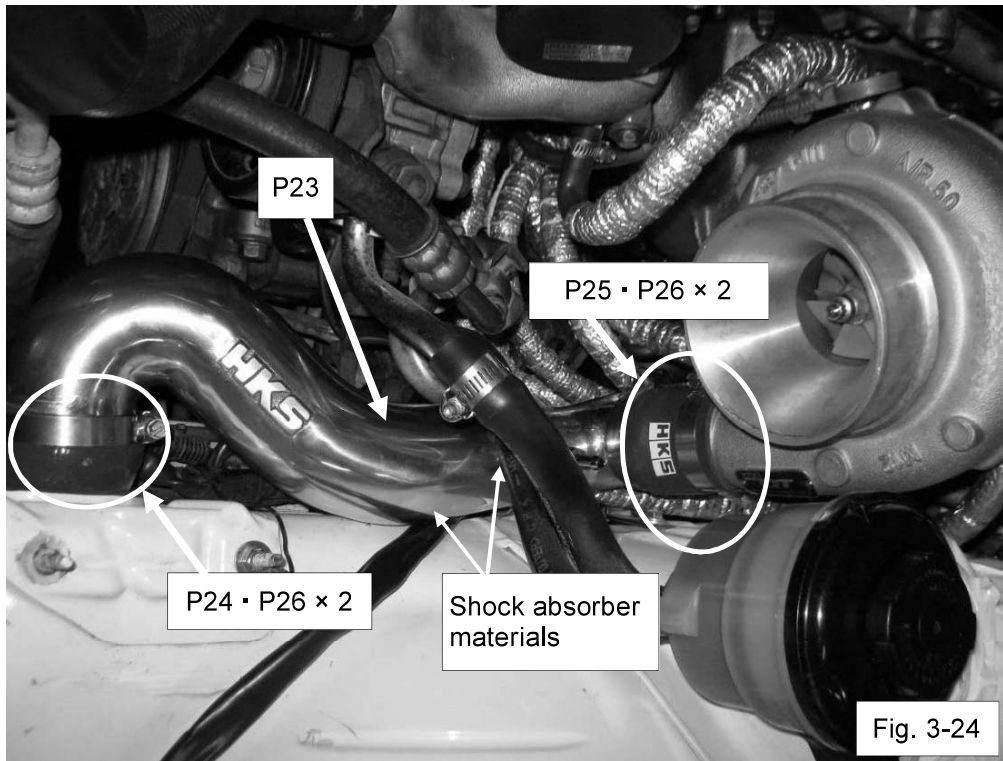

(25) Attach the  $\phi 6$  hose nipple to the chamber pipe, and connect it with the wastegate chamber pressure inlet and oil resistant hose  $\phi 6$ . (Fig. 3-25-1 and 3-25-2)

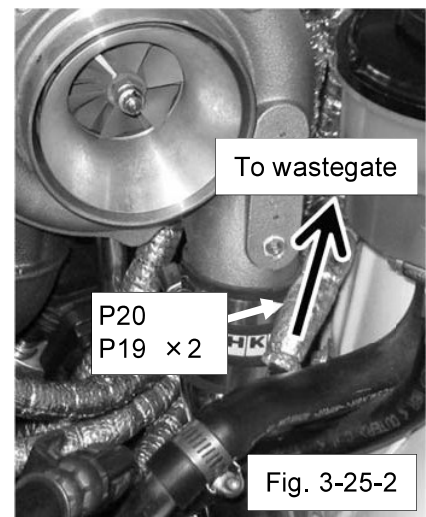
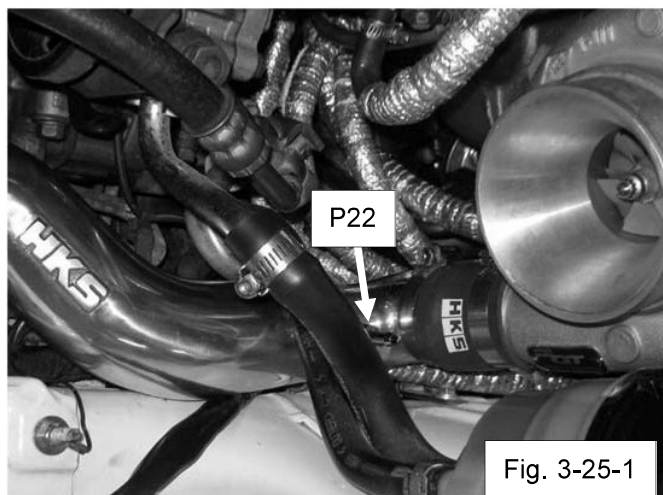

- (26) When installing it to the vehicle with ABS, make sure to protect ABS unit from the heat.  
<Recommendation>  
- For heat shield -  
Optional parts: 1499-RA039 Heat insulator for GT special full turbine kit (Fig. 3-26)

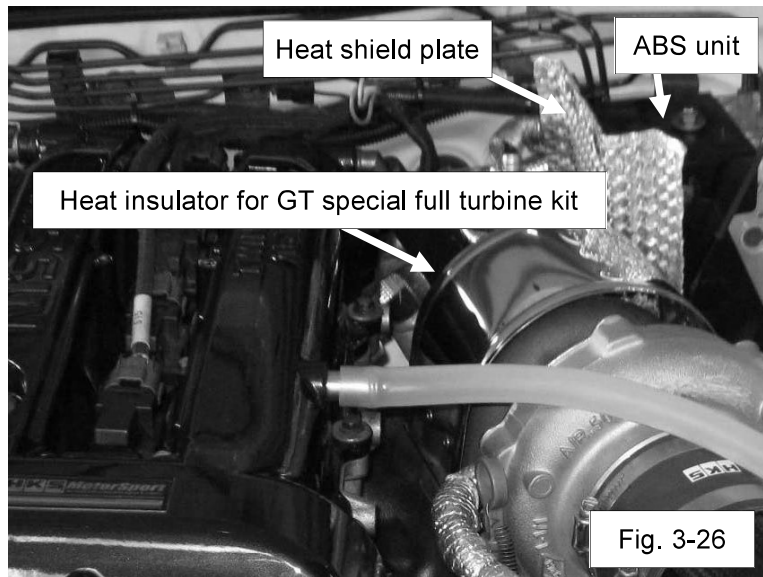

## 4. INSTALLATION OF NORMAL PARTS

- (1) Install the front pipe.
- (2) Attach the O<sub>2</sub> sensor (figure 1-7①) on the extension (turbo outlet).

**Tightening Torque N·m {kgf·m}**

$$T = 50 \pm 10 \{5.1 \pm 1\}$$

- (3) Attach the O<sub>2</sub> sensor connector.
- (4) Refill cooling water.
- (5) Refill power steering fluid
- (6) Reconnect the negative cable to the battery terminal.
- (7) Release the air of the cooling water and power steering fluid.
- (8) Reinstall the undercover.

*Note: After finish all installation process, please check all items with “Confirmation after Installation” page in Instruction Manual.*

## 5. BOOST SETTING

### 5-1.OPTION PARTS LIST

- (1) For higher boost pressure, use with HKS EVC and/or spring the wastegate spring with higher boost setting.
- (2) The following is the list of HKS EVC and wastegate springs that are available to use with this product.

No.	Code No.	Product	QTY	Remarks
1	45003-AK013	EVC7	1	
2	45003-AK009	EVC-S	1	
3	1405-RA035	Special Wastegate Spring	1	Boost Setting: 78.5-107.9kPa {0.8-1.1kgf/cm <sup>2</sup> } Identification paint color: Yellow
4	1405-RA036	Special Wastegate Spring	1	Boost Setting: 107.9-137.3kPa {1.1-1.4kgf/cm <sup>2</sup> } Identification paint color: Purple

Note: The Wastegate assembly included with this kit includes 1405-RA035.  
The actual boost pressure setting may vary depending on the vehicle's specification.

## 5-2.SPRING REPLACEMENT

(1) Hold the wastegate by a press or a similar tool toward the directions that arrows indicate in figure 5-2-1.

### Advice

Hold the wastegate through the bolts by the patch plate.

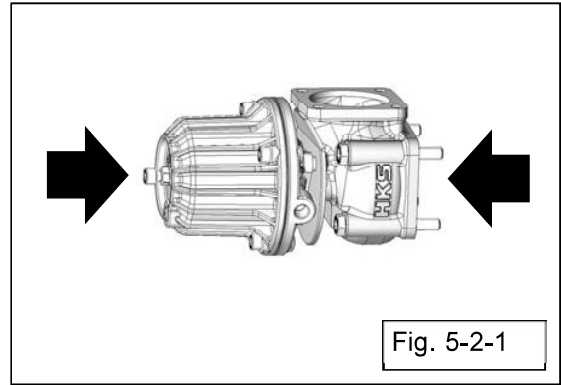

Fig. 5-2-1

## ⚠ CAUTION

- Without holding the wastegate with a press or a similar tool, spring may fly out and may cause serious injury.
- Make sure not to apply excessive force to the wastegate by a press or a similar tool.

(2) Remove the four cap bolts. (Fig.5-2-2)

(3) Slowly loosen the press holding the wastegate and remove the spring from the wastegate while being carefully not to let the spring fly out.

(4) Replace the spring, and reassemble the wastegate by a reverse procedure.

Tightening Torque: N · m(kgf · m)  
 $T = 7.7 \pm 1.5 (0.79 \pm 0.16)$

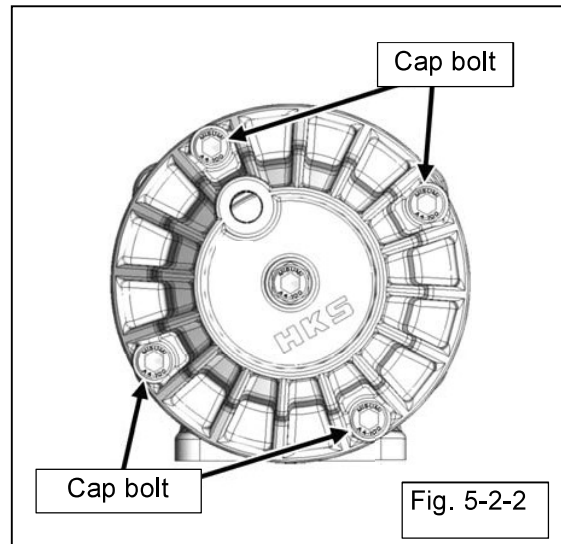

Fig. 5-2-2

### Advice

- The wastegate lower for contact to the wastegate upper temporarily attach the all screw bolts.  
 (The all screw bolts are not included this kit.)
- Attach the bolts on the wastegate upper and lower after contact.
- Tighten the opposing side bolts evenly to the tightening torque.

## WASTEGATE REPAIR PARTS LIST

No.	Code No.	Product	QTY	Remarks
1	14009-AK003	Gasket, Base Bypass II	1	2pcs/set
2	14009-AK005	Gasket, Bypass Out	1	2pcs/set
3	1499-RA057	Bellophragm	1	



HKS Co., Ltd.  
7181 Kitayama, Fujinomiya, Shizuoka 418-0192, Japan  
<http://www.hks-power.co.jp/>