



GT2 SUPERCHARGER Installation Manual

【For Authorized Dealers installing the HKS GT2 Supercharger:】

Give this manual to the end user.

Product	GT2 Supercharger
Manual Number	E04215-K00030-00 Ver.3-3.01

NOTICE

This manual assumes that you have and know how to use the tools and equipment necessary to safely perform service operations on your vehicle. This manual assumes that you are familiar with typical automotive systems and basic service and repair procedures. Do not attempt to carry out the operations shown in this manual unless these assumptions are correct. Always have access to a factory service manual. To avoid injury, follow the safety precautions contained in the factory service manual.

SAFETY PRECAUTIONS

- HKS will not be responsible for any and all damage to the vehicle's engine or other supplemental devices through the use of this product.
- There may be a noise (similar to a power steering pump with air in the lines) coming from the Supercharger unit right after the engine is started, or during idling. This is normal, as the noise should go away once the HKS Traction Fluid warms up (approx. 2-3 minutes).
- If the engine is started after the vehicle is stored for extended periods of time at lower than -20°C (-4°F), the viscosity of the HKS Traction Fluid will be thicker, and the engine may not start smoothly. (If this kit is used in cold climates where temperature is lower than -20°C (-4°F), HKS Traction Fluid must be used, which is sold separately. See Sec.7 Maintenance.)
- Make sure the temperature of the HKS Traction Fluid is less than 80°C (176°F) at the entrance of the Supercharger. If it's above 80°C (176°F), the Supercharger unit may become damaged.
- Make sure the maximum impeller speed is less than the designated rpm limit (refer to Table 1 below). If the impeller speed is operated at a higher speed, it may damage the Supercharger unit.
- Make sure the Supercharger is installed to rotate in the correct direction. The regular Supercharger should rotate clockwise while facing the front of the pulley. L-type rotate counterclockwise while facing the front of the pulley (see Diagram 1, the arrow indicates the rotation direction).

MODEL	MAX IMPELLER SPEED
	rpm
GTS4015HP	110,000
GT2-7040	110,000
GT2-7040L	110,000
GTS8555	100,000

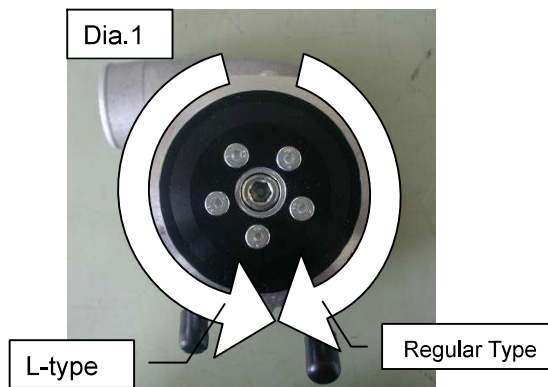

- When installing the Supercharger unit, make sure the side with the label is facing upward and the fittings are facing downward (see Diagram 2-1). Also, the angle of the upper part of the unit must be within $\pm 15^\circ$. If the angle exceeds $\pm 15^\circ$, the Supercharger may become damaged (see Diagram 2-2). The compressor housing can be installed in any direction; however, the bolts must be tightened securely to the tightening torque specified in Diagram 2-2.

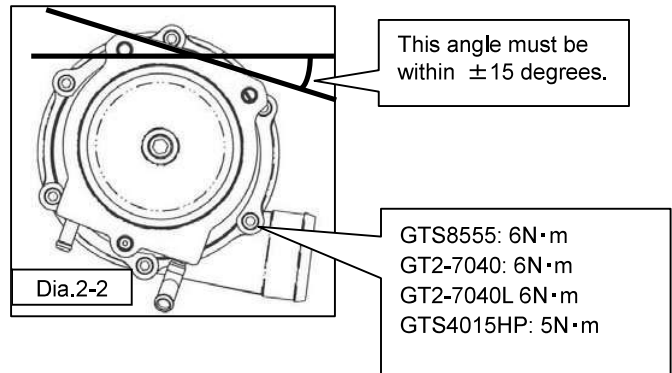
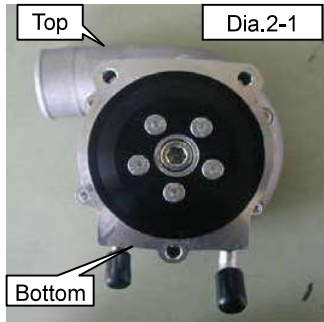

1. Parts List

No.	Part Number	Description	Qt	Remarks
1		Supercharger Unit	1	GTS4015HP
		Supercharger Unit	1	GT2-7040/GT2-7040L
		Supercharger Unit	1	GTS8555
2		Oil Tank Assembly	1	
3		Oil Cooler	1	
4	12002-AK029	GT S/C TRACTION FLUID I (800ml)	1	
5	12002-AK018	Inlet Pipe Gasket	1	GTS4015HP
	12002-AK013	Inlet Pipe Gasket	1	GT2-7040/GT2-7040L
	12002-AK014	Inlet Pipe Gasket	1	GTS8555
6	12002-AK015	Oil Filter Element	1	
7	12002-AK016	Hose 8mm L=3000	1	
8	12002-AK017	Hose 10mm L=2500	1	
9		Hose Clamp 8mm	4	1 mounted on S/C unit, 3 in bag
10		Hose Clamp 10mm	4	1 mounted on S/C unit, 3 in bag
11		Hexagon Cap Bolt	5	
12	18005-AK011	Hose Clamp #48	2	To mount the Oil Tank Assy.
13		Silicone Hose 70mm L=20	2	To mount the Oil Tank Assy.
14		Bracket	2	To mount the Oil Tank Assy.

※These parts must be used when installing the GT2 Supercharger.

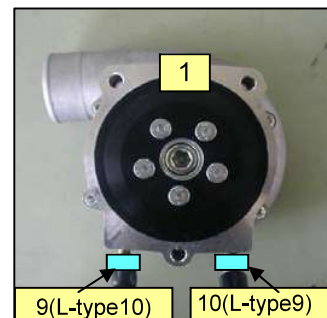
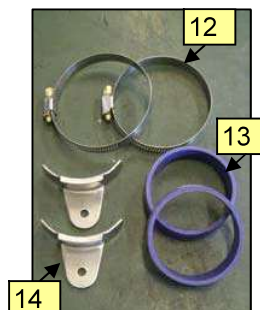
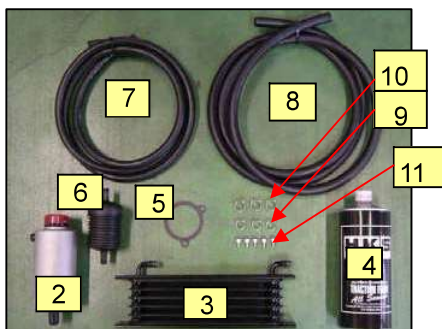

2. Pulley Belt

- For proper installation, use the appropriate pulley belt for each specific Supercharger application (refer to Table 2 below).

Table2

MODEL	Recommended Belt
GTS4015HP	5PK(5 Rib)
GT2-7040/GT2-7040L	7PK(7 Rib)
GTS8555	8PK(8 Rib)

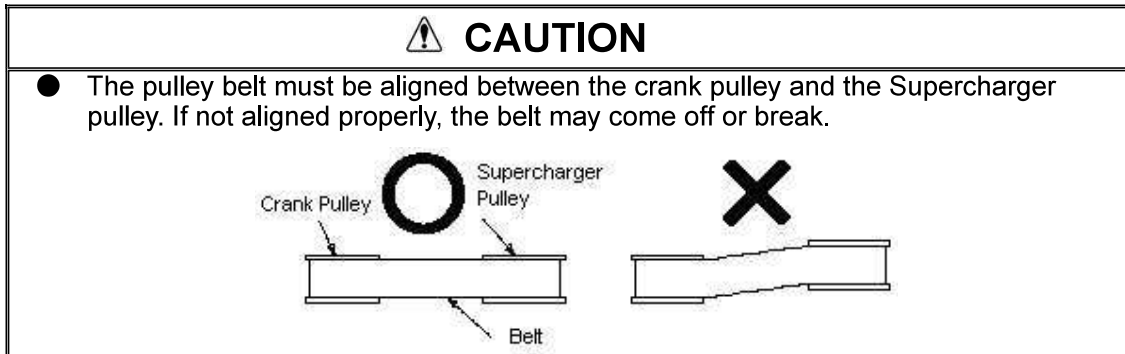

3. Oil Tank

The oil tank must be mounted so that the distance between the bottom of the oil tank and the upper side of the Supercharger unit is within 60cm (23.6"). If the distance is more than 60cm (23.6"), it may cause an oil volume shortage and damage to the Supercharger.

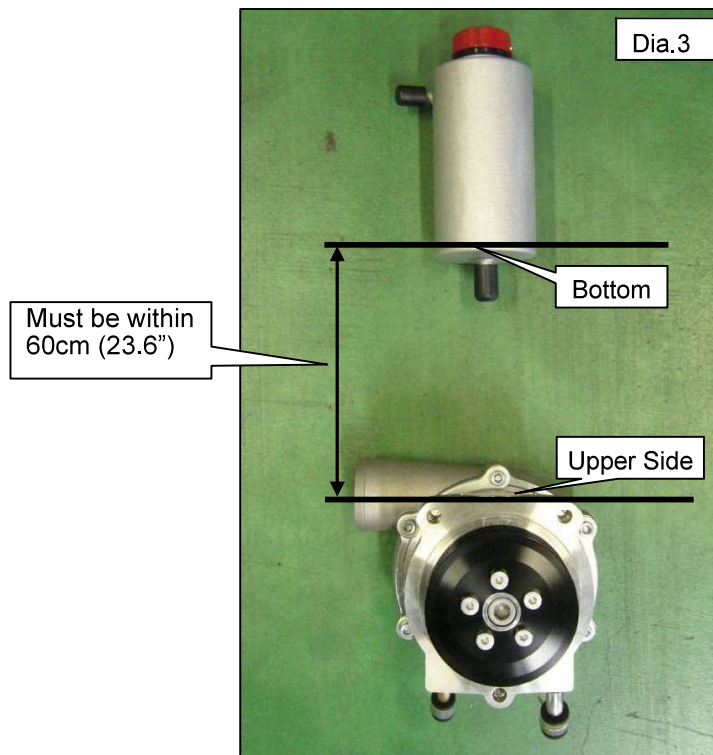

4. Hose Connections

- (1) The arrows in Diagram 4 indicate the flow of traction fluid.
- (2) Place the oil filter element in the position shown in Diagram 4.
- (3) Use the 10mm hoses to connect the oil tank, oil filter, and Supercharger as shown in Diagram 4. The total length of the two 10mm hoses must be less than 4m (157"). If the hose length is longer than 4m (157"), it may cause an oil volume shortage and damage to the Supercharger.

Use the 8mm hoses to connect the Supercharger, oil cooler, and oil tank as shown in Diagram 4. The total length of two 8mm hoses must be less than 4m (157"). If the hose length is longer than 4m (157"), it may cause an oil volume shortage and damage to the Supercharger.

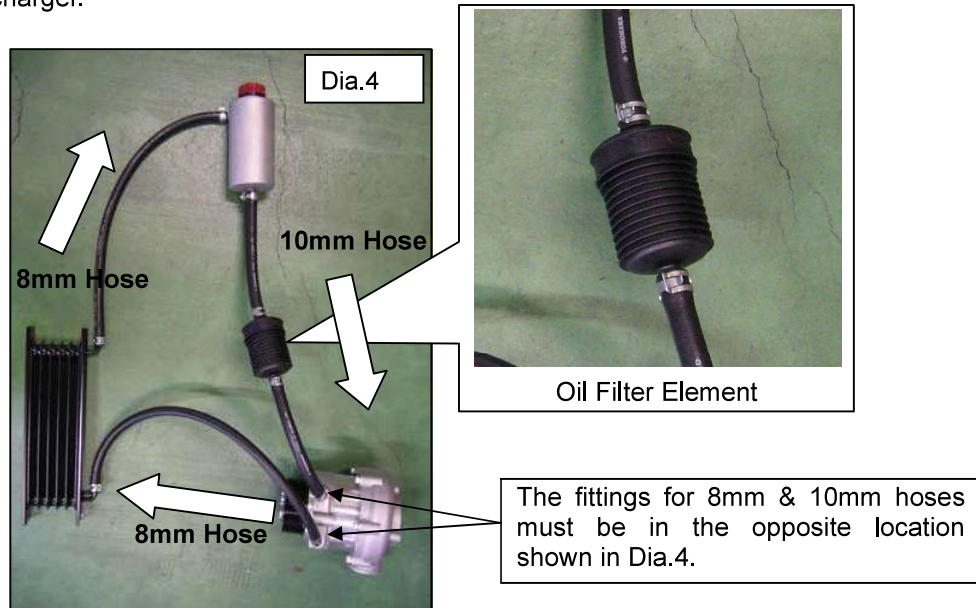

CAUTION

- The Supercharger unit is made with precision components. If any foreign objects should become mixed with the oil, the Supercharger may become damaged. Make sure the hoses and/or fitting ends are covered to prevent foreign objects from getting inside the hoses, tank and/or cooler.
- Due to the special HKS Traction Fluid, the provided hoses must be used. Non-specified hoses can deteriorate or become damaged.

5. Filling the HKS Traction Fluid

Make sure there are no foreign objects in the Oil Tank. Pour the HKS Traction Fluid to the level of ① in Diagram 5.

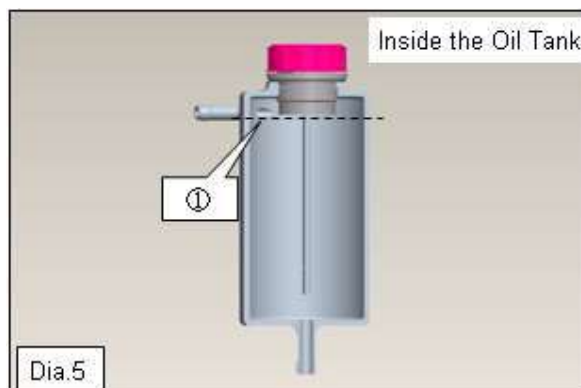

6. Confirmation after Installation

Check the following after the installation process is complete.

(1) Check the following before starting the engine:

	Confirmation	Check
1	Make sure the traction fluid hose layout is correct.	
2	Make sure the HKS Traction Fluid is not leaking.	
3	Make sure the installed parts do not come in contact with any other parts.	
4	Make sure the belt tension is correct.	
5	Make sure all bolts (especially the bolts that secure a pulley) are tightened properly.	
6	Make sure the HKS Traction Fluid is filled to the specified level in the Oil Tank assembly. (Dia.5)	
7	Make sure hoses are not kinked or bent.	
8	Make sure all hose clamps are tightened securely.	
9	Make sure all bolts and nuts are tightened securely.	
10	Make sure all installed components are properly secured.	

(2) Prepare approximately 80cc (2.7 oz) of the HKS Traction Fluid in a beaker/small container, and start the engine.

(3) Immediately after starting the engine, perform the following:

1. Make sure that the oil level in the oil tank starts to decline and the HKS Traction Fluid returns to the oil tank.
2. Add the HKS Traction Fluid from the beaker/small container so the oil tank does not get empty.

CAUTION: Make sure the oil tank does not overflow.

NOTE

- There may be a noise (similar to a power steering pump with air in the lines) coming from the Supercharger unit right after the engine is started, or during idling. This is normal, as the noise should go away once the HKS Traction Fluid warms up (approx. 2-3 minutes).

(4) Start the engine. Once the engine reaches its normal operating temperature, check the following.

CAUTION: Do not raise the engine RPM until the engine reaches its normal operation temperature, let it idle.

	Confirmation	Check
1	Make sure the HKS Traction Fluid returns to the oil tank.	
2	Make sure the traction fluid and air are not leaking from the fluid lines and/or piping.	
3	Make sure there is no excessive stress on hoses.	
4	Make sure the installed parts do not come in contact with any other parts.	

- (5) After checking the above items, keep the RPM stable at 2000rpm for about 10 seconds. Shut the engine off and check the HKS Traction Fluid level. The oil level needs to be at level ① (See Dia.6). If it is not, make the proper adjustment.

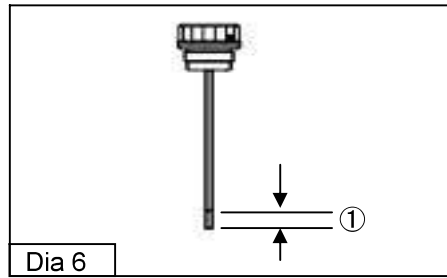

- ※ If there is a surplus of the HKS Traction Fluid remaining in the bottle, put the cap on and store it in a safe location. Always store the HKS Traction Fluid in its original bottle to prevent any oil composition change.

7. Maintenance

Periodically inspect the following parts and replace if necessary:

Inspection / Replacement		
1	HKS Traction Fluid	Replacement is not necessary. Add oil only if needed.
2	Oil Filter	Replace every 5 years.

○Parts that require inspection

1. HKS Traction Fluid

- The HKS Traction Fluid was designed specifically for the HKS GT2 Supercharger. Do not use any other types of oil. Use of other brands of the traction oil can lead to damage to the HKS GT2 Supercharger.

 CAUTION
The HKS Traction Fluid does not need to be replaced. However, periodically check the oil level prior to driving. If the oil level is low, add the HKS Traction Fluid as necessary.

- The HKS Traction Fluid can be purchased through an Authorized HKS Dealer using the part number below.

Part Name	Part Number
GT S/C TRACTION FLUID I (800ml)	12002-AK029

- If this kit is used in cold climate where temperature is lower than -20°C (-4°F), the following HKS Traction Fluid must be used. (Sold separately.)

Part Name	Part Number
GT S/C TRACTION FLUID II (800ml)	12002-AK030

 CAUTION
● When changing the traction fluid, make sure to follow the procedures described in section 4 to 7 after the fluid was drained from the oil tank, oil cooler and hoses.

- Replace the Oil Filter Element every 5 years after installing the HKS GT2 Supercharger. The Oil Filter Element can be purchased through an Authorized HKS Dealer using the part number below.

Part Name	Part Number
Oil Filter Element	12002-AK015

○ Check the Traction Fluid Level

- After idling, keep the RPM stable at 2000rpm for about 10 seconds. Shut the engine off and check the HKS Traction Fluid level. The fluid level needs to be at level ① (See Dia.6). If it is not, make the proper adjustment.

2. Belt

Belts are consumable parts. On a regular basis, check all belts for cracks, tears, and correct tension.

CAUTION

- Make sure the belt is correctly aligned with the grooves on the pulley. If it is not aligned properly, it may damage the belt.
- To avoid possible belt slippage, make sure no oil or coolant gets on the belt.

Inspection Before Driving

- Check the following before driving the vehicle with the installed Supercharger.
- If any problems are found after inspection, consult your Authorized HKS Dealer/installer.

Entry Method	No Problem	<input checked="" type="checkbox"/> Exchange	<input type="checkbox"/> ×	Adjust	A	Tighten	T
--------------	------------	--	----------------------------	--------	---	---------	---

Inspection Item	
1	<p><u>Supercharger Check</u></p> <div style="border: 1px solid black; padding: 5px; margin: 10px 0;"> <p style="text-align: center;"> WARNING</p> <ul style="list-style-type: none"> ▪ When checking the Supercharger, avoid touching any moving belts and keep all loose clothing away. ▪ Touching a moving belt or allowing loose clothes to come in contact with a belt can lead to severe injury. </div> <p>Compare the operating sound currently against initial installation. Check for increased sound levels or unusual noises. <input type="checkbox"/></p> <p>Compare the sound of the air cleaner against initial installation. Check for increased intake sound levels or unusual noises. <input type="checkbox"/></p> <p>Check the HKS Traction Fluid level. Has the oil level excessively decreased? <input type="checkbox"/></p>
2	<p><u>Traction Fluid Hose Inspection</u></p> <p>Check for the HKS Traction Fluid leaks coming from the oil hoses or loose hose clamps. <input type="checkbox"/></p> <p>Locations: <input type="checkbox"/></p> <ul style="list-style-type: none"> ▪ Connection at the Supercharger <input type="checkbox"/> ▪ Connection at the oil cooler <input type="checkbox"/> ▪ Connection at the oil tank <input type="checkbox"/> ▪ Connection at the oil filter element <input type="checkbox"/> <p>Check for damage to the hoses due to interference with other parts. <input type="checkbox"/></p> <p>Check for cracks or cuts in the hoses. <input type="checkbox"/></p> <p>Check if the HKS Traction Fluid is filled to the marked level on the oil level gauge. <input type="checkbox"/></p>
3	<p><u>Belt Inspection</u></p> <p>Check for cracks or tears on the belt. <input type="checkbox"/></p>



HKS Co., Ltd.

7181 Kitayama Fujinomiya-shi Shizuoka 418-0192, Japan

<http://www.hks-power.co.jp/>