



INSTALLATION MANUAL

NAME OF PRODUCT	GT SUPERCHARGER SYSTEM																
PART NUMBER	PRO KIT (P/N: 12001-AH008, 12002-AH002)																
APPLICATION	HONDA CR-Z (DAA-ZF1)																
ENGINE	LEA-MF6																
YEAR	2010/02-2012/08																
REMARKS	<ul style="list-style-type: none"> ▪ HKS will not be responsible for any and all damage to the vehicle's engine or other supplemental devices through the use of this product. ▪ This product is best used with the following parts on the Recommended Parts List. ▪ Using this product with any other parts may result in engine damage. ▪ HKS will not be responsible for any damage caused by using this product with any other parts. ▪ High octane gasoline must be used ▪ DENSO Washer Assy (160200-5070) may be required due to the removal of the factory washer tank when installing this kit. <table border="1" style="margin-left: 40px; margin-bottom: 20px;"> <thead> <tr> <th colspan="2" style="text-align: center;">Pro Kit Designated Parts List</th> </tr> </thead> <tbody> <tr> <td style="width: 30%;">Spark Plug</td> <td>HKS Super Fire Racing M40i or NGK heat range 8 equivalent.</td> </tr> <tr> <td>Engine Oil</td> <td>HKS Engine Oil (Oil Viscosity must be 25W or higher.)</td> </tr> </tbody> </table> <table border="1" style="margin-left: 40px;"> <thead> <tr> <th colspan="2" style="text-align: center;">Pro Kit Recommended Parts List</th> </tr> </thead> <tbody> <tr> <td style="width: 30%;">Catalytic Converter</td> <td>OEM or HKS Metal Catalyzer</td> </tr> <tr> <td>Mid-Pipe</td> <td>OEM or HKS SUS Center Pipe</td> </tr> <tr> <td>Muffler/Exhaust</td> <td>OEM or HKS Silent Hi-Power Exhaust or HKS LEGA MAX Premium Exhaust</td> </tr> <tr> <td>Fuel Upgrade Parts</td> <td>HKS Fuel Upgrade Kit for GTSC</td> </tr> </tbody> </table> <ul style="list-style-type: none"> ▪ HKS will not be responsible for any damage caused by the use of this product beyond the impeller's maximum RPM limit (110,000rpm) and/or the specified engine RPM. 	Pro Kit Designated Parts List		Spark Plug	HKS Super Fire Racing M40i or NGK heat range 8 equivalent.	Engine Oil	HKS Engine Oil (Oil Viscosity must be 25W or higher.)	Pro Kit Recommended Parts List		Catalytic Converter	OEM or HKS Metal Catalyzer	Mid-Pipe	OEM or HKS SUS Center Pipe	Muffler/Exhaust	OEM or HKS Silent Hi-Power Exhaust or HKS LEGA MAX Premium Exhaust	Fuel Upgrade Parts	HKS Fuel Upgrade Kit for GTSC
Pro Kit Designated Parts List																	
Spark Plug	HKS Super Fire Racing M40i or NGK heat range 8 equivalent.																
Engine Oil	HKS Engine Oil (Oil Viscosity must be 25W or higher.)																
Pro Kit Recommended Parts List																	
Catalytic Converter	OEM or HKS Metal Catalyzer																
Mid-Pipe	OEM or HKS SUS Center Pipe																
Muffler/Exhaust	OEM or HKS Silent Hi-Power Exhaust or HKS LEGA MAX Premium Exhaust																
Fuel Upgrade Parts	HKS Fuel Upgrade Kit for GTSC																

REVISION OF MANUAL

Rev. Number	Date	Manual Number	Details
3-3.01	2015/07	E04215-H15080-00	1 st Edition
3-3.02	2016/03	E04215-H15081-00	2 nd Edition

Published in March 2016 by HKS Co., Ltd. (Unauthorized reproduction is strictly prohibited.)

NOTICE

This manual assumes that you have and know how to use the tools and equipment necessary to safely perform service operations on your vehicle. This manual assumes that you are familiar with typical automotive systems and basic service and repair procedures. Do not attempt to carry out the operations shown in this manual unless these assumptions are correct. Always have access to a factory service manual. To avoid injury, follow the safety precautions contained in the factory service manual.

ATTENTION

- This manual indicates items you need to pay attention to in order to install this product safely and lists precautions to avoid any possible damage and/or accidents.
- This product is an automobile part. Do not use for any other purposes.
- HKS will not be responsible for any damage caused by incorrect installation and/or use, or use after modification and/or dismantling of this product.
- This product was designed for installation on a specific factory vehicle.
- The specifications of this product are subject to change without notice.
- The instructions are subject to change without notice. Make sure to refer to the most recent instructions.
- This manual shows instructions for the JDM and USDM vehicles. There are some procedures shown with asterisk marks; these must be performed only for a specific type of vehicle. Make sure to perform those procedures only if they are required for your vehicle type.
- This kit includes all parts required to install to both the JDM and USDM vehicles. There are some parts that are required only for a specific type of vehicle. See the remarks of the parts list.

APPLICATION DATA

If the maximum engine output is more than 200PS, it is recommended to replace and/or modify the factory water pump pulley, A/C pulley and crank pulley to 6 rib since slippage of the 4 rib belt may occur. Refer to the application list below for the suggested 6 rib belt when replacing and/or modifying the factory pulleys.

Pulley	Outside Diameter
Water Pump Pulley	Same as the factory pulley (The width should be wider.)
A/C Pulley	127.7mm (Shave all 4 ribs on the factory pulley. Prepare a 6 rib ring and press fit the ring to the pulley.)
Crank Pulley	Same as the factory pulley (Add 2 ribs to the pulley.)

Supercharger Pulley Application List

Supercharger Pulley Diameter	※① Impeller Max RPM (at 6500rpm)	4 Rib Belt	※② 6 Rib Belt (Ref. Data)
φ100 (Boost: 0.8kgf/cm ²)	Approx. 98000	4PK1260	6PK1265
φ95 (Boost: 0.9kgf/cm ²)	Approx. 103000	4PK1250	6PK1260
φ90 (Boost: 1.0kgf/cm ²)	Approx. 109000	4PK1240	6PK1245
φ85 (Boost: 1.2kgf/cm ²)	Approx. 115500		6PK1240
φ80 (Boost: 1.4kgf/cm ²)	Approx. 122700		6PK1230

For safety precautions and product warranty liabilities, the impeller's maximum RPM should not exceed 110,000 rpm. HKS will not be responsible for any damage caused by the use of this product beyond the impeller's maximum RPM limit.

PARTS LIST

NO.	DESCRIPTION	QT	REMARKS
1	Supercharger Unit Kit	1	GTS7040
2	Oil Filter	1	
3	Oil Tank	1	
4	Traction Oil	1	
5	Oil Cooler	1	
6	Elbow Fitting	2	
7	Pulley 60mm	2	
8	Supercharger Unit Pulley	1	90mm
9	Belt	1	4PK1240
10	Intercooler	1	
11	Restrictor $\phi 27$ (For JDM Factory Fuel Spec.)	1	Hole Dia.: $\phi 27$ ※Only For JDM vehicle
12	Bypass Valve Assembly	1	
13	Air Filter	1	150mm-80mm Red
14	Hose 4mm	1	500mm
15	Hose 8mm	1	3000mm
16	Hose 10mm	1	1250mm
17	Hose 22mm	1	500mm
18	Oil Resistant Hose 10mm	1	1000mm
19	Corrugated Tube for Sensor Wiring	1	
20	Corrugated Tube 8mm	1	
21	Corrugated Tube 10mm	1	
22	Corrugated Tube 22mm	1	
23	Intercooler Inlet Pipe No.1	1	
24	Intercooler Inlet Pipe No.2	1	

PARTS LIST

NO.	DESCRIPTION	QT	REMARKS
25	Intercooler Inlet Pipe No.3	1	
26	Intercooler Outlet Pipe No.1	1	
27	Intercooler Outlet Pipe No.2	1	
28	Intercooler Outlet Pipe No.3	1	
29	Suction Pipe No.1	1	
30	Suction Pipe No.2	1	
31	Suction Adapter	1	
32	Supercharger Bracket No.1	1	
33	Supercharger Bracket No.2	1	
34	Tensioner Bracket No.1	1	
35	Tensioner Bracket No.2	1	
36	Oil Tank Bracket	1	
37	Intercooler Inlet Pipe Bracket	1	
38	Oil Cooler Bracket No.1	1	
39	Oil Cooler Bracket No.2	1	
40	Oil Cooler Bracket No.3	1	
41	Intercooler Outlet Pipe Bracket No.1	1	
42	Intercooler Outlet Pipe Bracket No.2	1	
43	Intercooler Bracket	1	
44	Suction Pipe Bracket	1	
45	Universal Pipe Bracket 50mm	3	
46	Universal Pipe Bracket 80mm	1	
47	Suction Pipe Gasket	1	
48	Silicone Hose 50mm L=20	2	

PARTS LIST

NO.	DESCRIPTION	QT	REMARKS
49	Silicone Hose 50mm L=55	4	
50	Silicone Hose 50mm L=70	1	
51	Silicone Hose 60mm L=55	1	
52	Silicone Hose 70mm L=20	2	
53	Silicone Hose 80mm L=55	1	
54	Different Dia. Silicone Hose 60-80mm	1	
55	Cushion Hose 50mm L=75	2	
56	Cushion Hose 60mm L=75	1	
57	Spacer M4 L=1.5	2	Brass
58	Spacer M8 L=5	1	
59	Spacer M8 L=10	1	※Only for USDM vehicle
60	Spacer M8 L=25	2	
61	Spacer M10 L=4	2	
62	Hose Fitting 4mm	1	
63	Hose Fitting 10mm	3	
64	Hose Clip 8mm	3	
65	Hose Clip 10mm	2	
66	Hose Clamp #4	5	
67	Hose Clamp #16	2	
68	Hose Clamp #28	16	
69	Hose Clamp #36	6	
70	Hose Clamp #40	2	
71	Hose Clamp #48	3	
72	Elbow PT1/8	1	
73	3-way Connector PT1/8	1	

PARTS LIST

NO.	DESCRIPTION	QT	REMARKS
74	Hexagon Bolt M6 L=15	8	
75	Hexagon Bolt M8 L=15	4	
76	Hexagon Bolt M8 L=20	3	
77	Hexagon Bolt M8 L=30	1	※Only for USDM vehicle
78	Hexagon Bolt M10 L=20	1	
79	Button Bolt M4 L-12	1	For Airflow Adapter
80	Cap Bolt M6 L=12	5	Low Head Type
81	Cap Bolt M6 L=15	3	
82	Cap Bolt M8 L=15	2	
83	Cap Bolt M8 L=50	2	
84	Cap Bolt M8 L=70	1	
85	Cap Bolt M10 L=20	2	
86	Cap Bolt M10 L=35	3	
87	Cap Bolt M10 L=45	1	
88	Flat Head Bolt M8 L=35	3	
89	Lock Washer M6	8	
90	Lock Washer M8	7	
91	Lock Washer M10	1	
92	Washer M6	11	
93	Washer M8	13	※For JDM vehicle, use only 12 pcs.
94	Washer M10	7	
95	Flange Nut M6	4	
96	Flange Nut M8	6	
97	Flange Nut M10	1	

PARTS LIST

NO.	DESCRIPTION	QT	REMARKS
98	Sponge Sheet	3	
99	Tie Wrap (Large)	5	
100	Tie Wrap (Medium)	10	
101	Tie Wrap (Small)	10	
102	High-Octane Decal	1	
103	Instruction Manual	1	For Supercharger Kit
104	Installation Manual	1	For Supercharger Unit Kit
105	Initialization Tool (USB Memory)	1	※Only for JDM vehicle

1. Removal of Factory Parts

Refer to this instruction manual and the factory service manual to remove the factory parts.

(1) Disconnect the negative cable from the battery.

(2) Remove the intake air tube ①.

(3) Remove the resonator chamber joint ②.

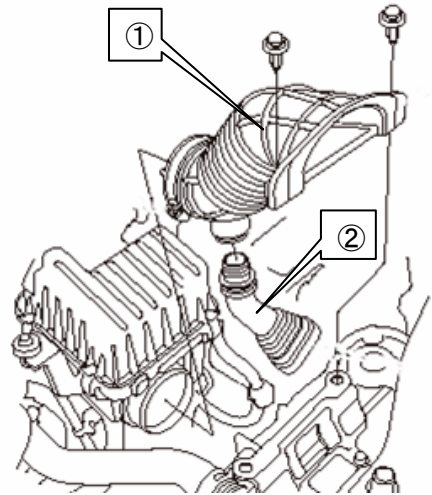

(4) Remove the air cleaner①.

(5) Disconnect the airflow sensor connector ②.

(6) Disconnect the air flow sensor ③.

NOTE

- Keep the removed bolts for later use.

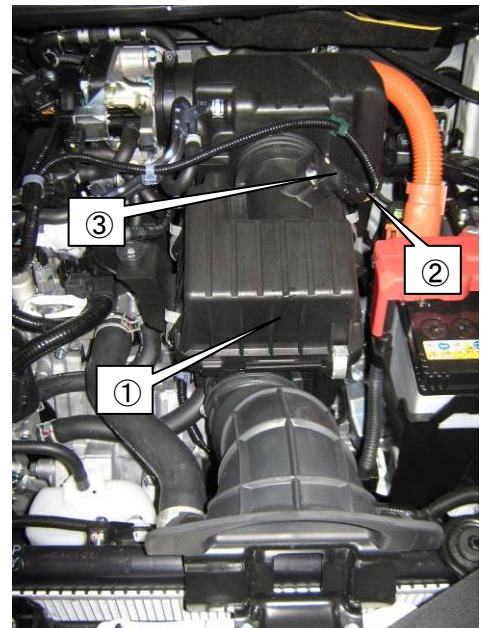

(7) Remove the left and right side splash shields.

(8) Remove the engine under cover.

(9) Remove the resonator ①.

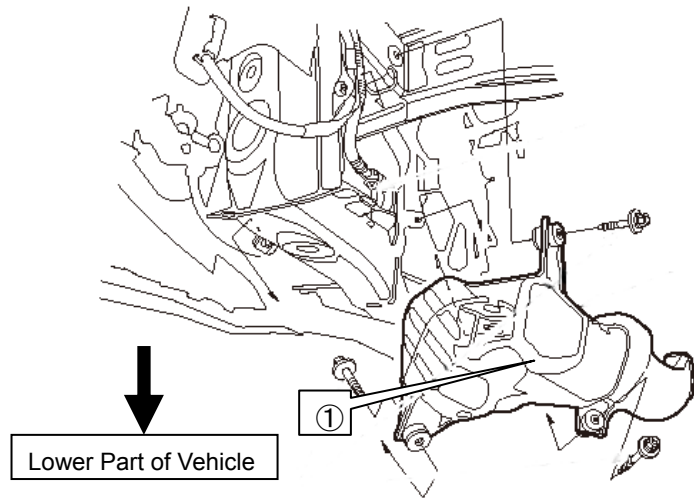

(10) Remove the front bumper side cover ①.

(11) Remove the front bumper center seal ②.

(12) Remove the front bumper ③.

(13) Remove the front bumper center upper beam ④.

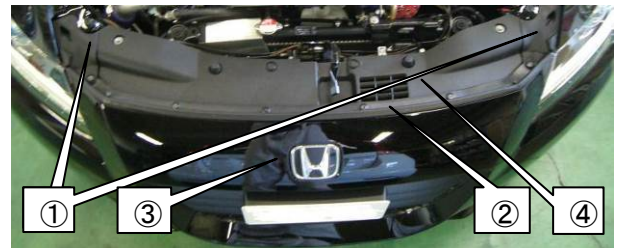

(14) Remove the front bumper air guide ①.

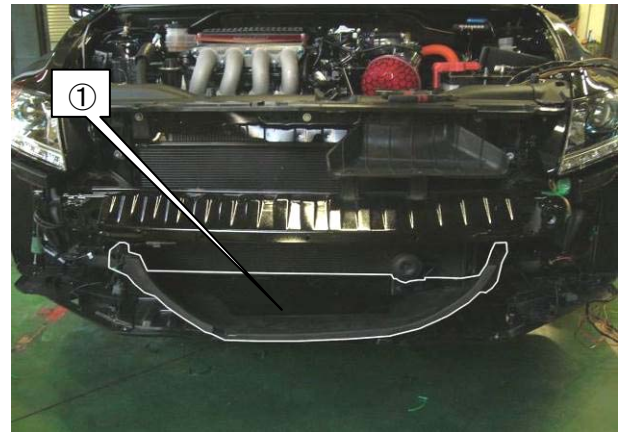

(15) Remove the right side headlight.

(16) Disconnect the hose and connector from the pump, and remove the washer tank ①.

NOTE

- Prepare a replacement such as DENSO 160200-5070 Washer Assy.



(17) Reinstall the headlight in a later step.

(18) Turn the auto tensioner pulley counterclockwise, and remove the belt. When turning the auto tensioner, use a tool ① such as Honda factory tool or box spanner. Place the tool as shown in the diagram on the right.

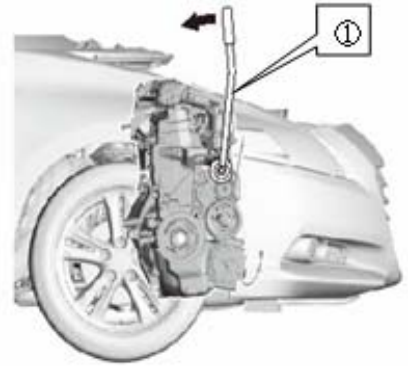

(19) Remove the auto tensioner.

(20) Remove the bolt ②.

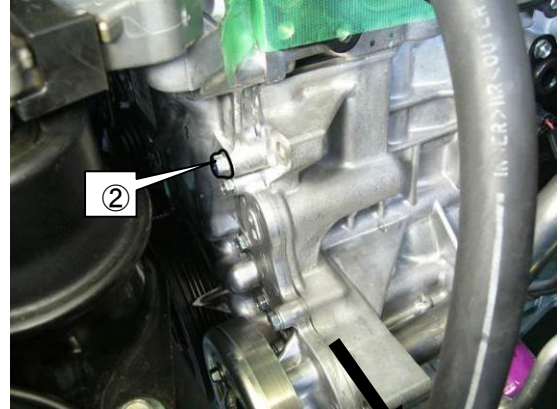
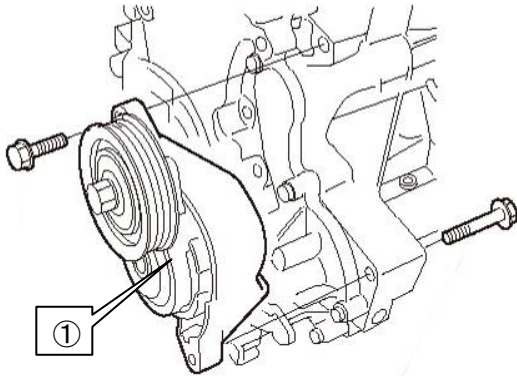

Vehicle's Front

(21) Remove the intake manifold ①.

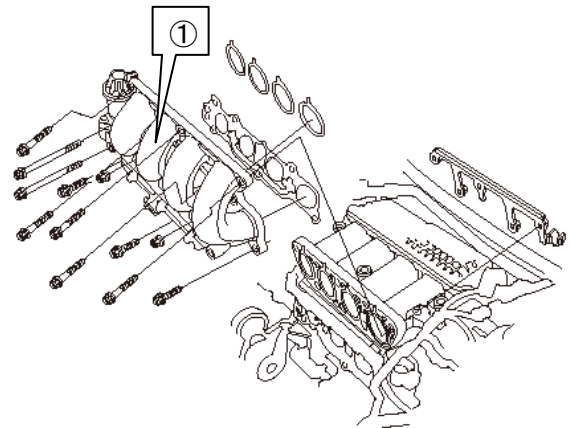

2. Installation of Oil Cooler

PARTS LIST

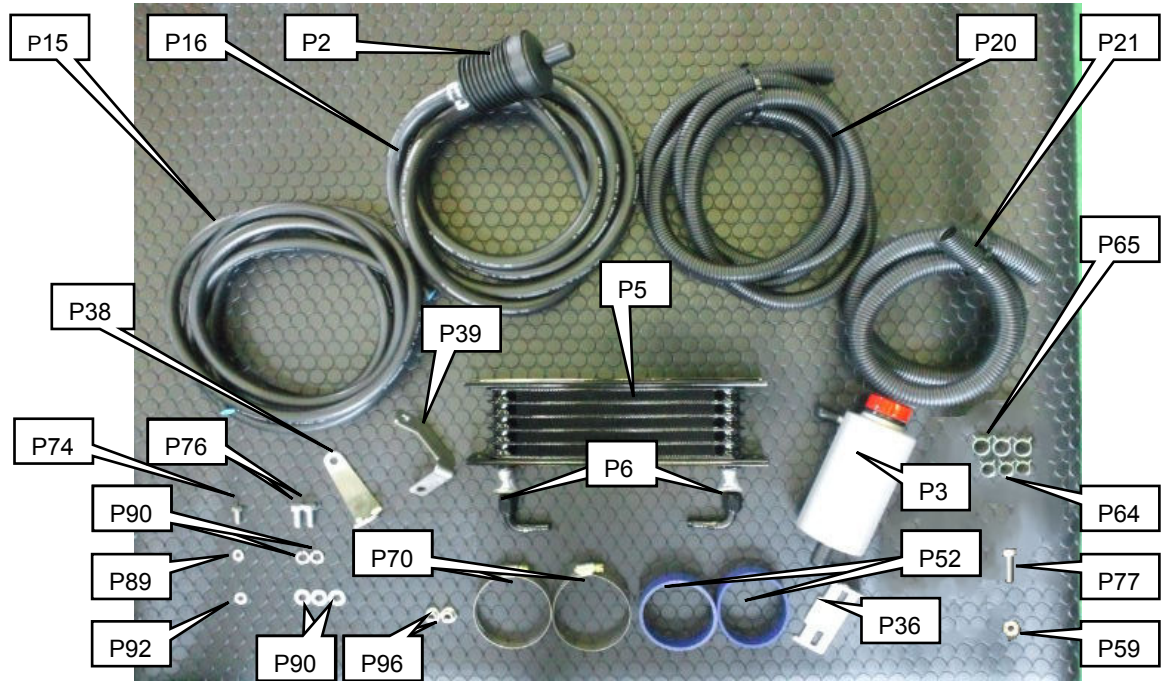

No.	Description	QT
P2	Oil Filter	1
P3	Oil Tank	1
P5	Oil Cooler	1
P6	Elbow Fitting	2
P15	Hose 8mm	1
P16	Hose 10mm	1
P20	Corrugated Tube 8mm	1
P21	Corrugated Tube 10mm	1
P36	Oil Tank Bracket	1
P38	Oil Cooler Bracket No.1	1
P39	Oil Cooler Bracket No.2	1
P52	Silicone Hose 70mm L=20	2
P59	Spacer M8 L=10	1
P64	Hose Clip 8mm	3
P65	Hose Clip 10mm	3
P70	Hose Clamp #40	2
P74	Hexagon Bolt M6 L=15	1
P76	Hexagon Bolt M8 L=20	2
P77	Hexagon Bolt M8 L=30	1
P89	Lock Washer M6	1
P90	Lock Washer M8	2
P92	Washer M6	1
P93	Washer M8	3
P96	Flange Nut M8	2

- (1) Cut the Hose 8mm to 1000mm and 1250mm. Cut the Hose 10mm to 350mm and 570mm.

NOTE

- When cutting the 10mm Hose, do not disconnect the hose from the oil filter as shown in the diagram on the right.

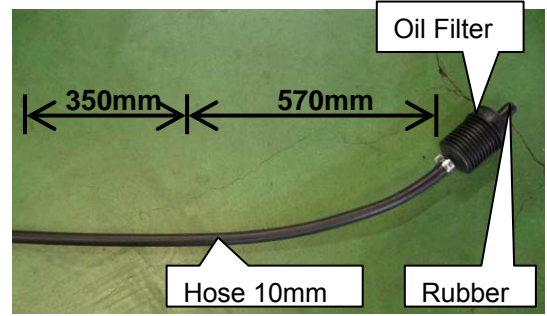

- (2) Remove the rubber cap from the Oil Filter.

- (3) Cut the Corrugated Tube 8mm to 1000mm and 1250mm, and cut the Corrugated Tube 10mm to 350mm and 570mm. Cover each cut hose with the cut Corrugated Tube of the same length.

- (4) Connect the cut Hose 10mm to the other side of the Oil Filter ② using the 10mm Hose Clamp ①.

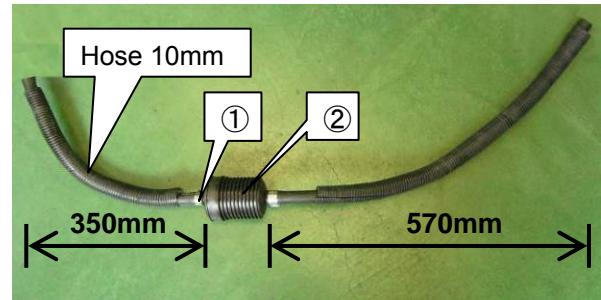

- (5) Install the Oil Tank Bracket to the Oil Tank ③ using the Silicone Hose 70mm L=20 ① and Hose Clamp #40 ②.

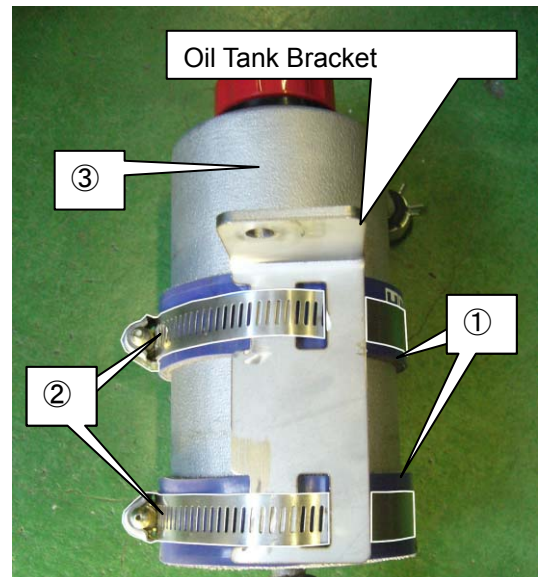

- (6) Remove the rubber cap from the hose fitting on the lower part of the Oil Tank and connect the Hose 10mm ② using the Hose Clip 10mm ①.

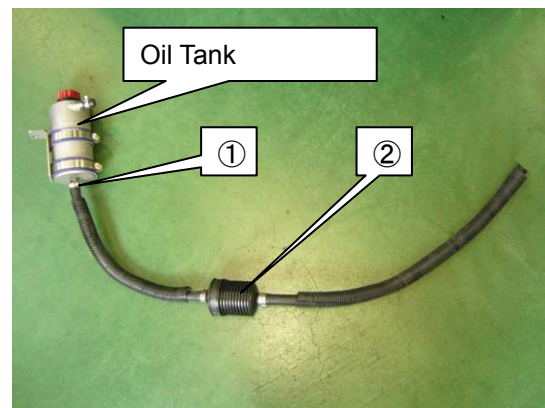

(7) Route the hose as shown in the diagrams below. Install the Oil Tank Assy to the vehicle using the following parts.

- ① Hexagon Bolt M6 L=15
- ② Lock Washer M6
- ③ Washer M6

NOTE

• Adjust the angle of the Oil Tank Assy so the hose does not get kinked.

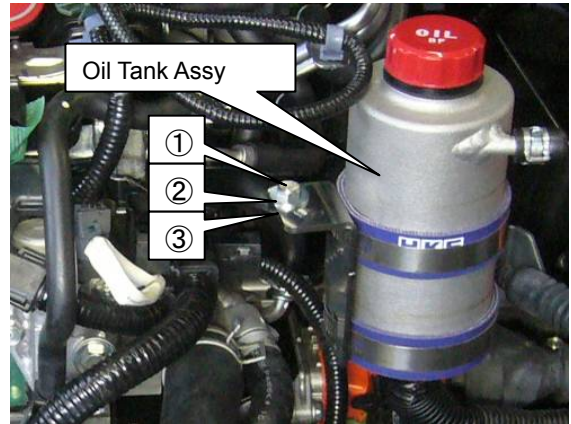

(8) Install the Elbow Fittings to the Oil Cooler ①.

NOTE

• Install the Fittings in the directions shown in the diagram on the right.

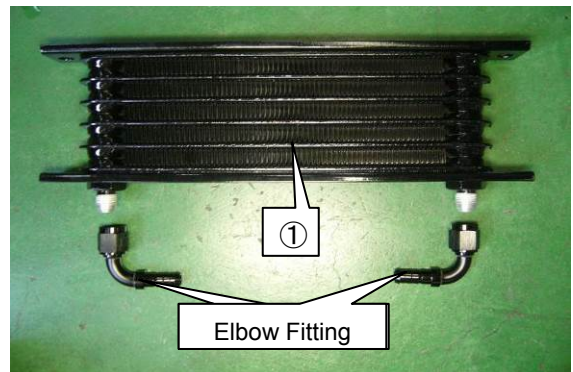

(9) Connect the 1000mm Hose 8mm ① and the 1250mm Hose 8mm ② to the Oil Cooler using the 8mm Hose Clamps ③.

(10) Install Oil Cooler Bracket No.1 ④ and Oil Cooler Bracket No.2 ⑤ to the Oil Cooler using the following parts.

- ⑥ Hexagon Bolt M8 L=20
- ⑦ Lock Washer M8
- ⑧ Washer M8
- ⑨ Flange Nut M8

NOTE

• When installing ⑤ Traction Oil Cooler Bracket No. 2, for a JDM vehicle, pull the bracket toward side A, and for a USDM vehicle, pull the bracket toward side B.

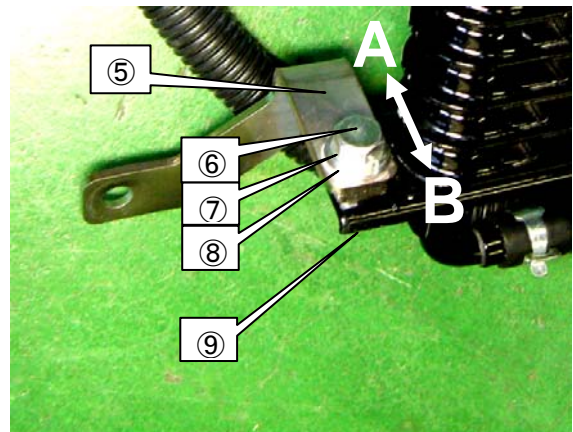
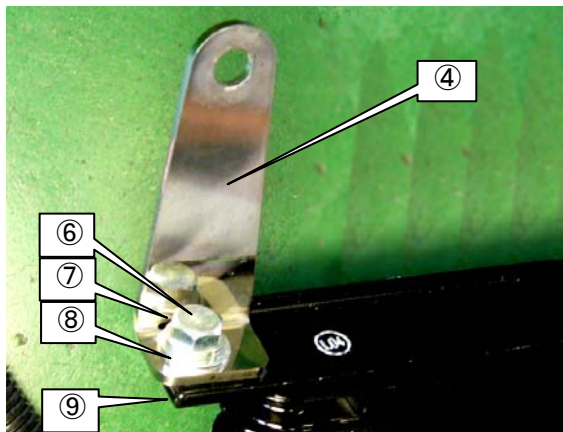
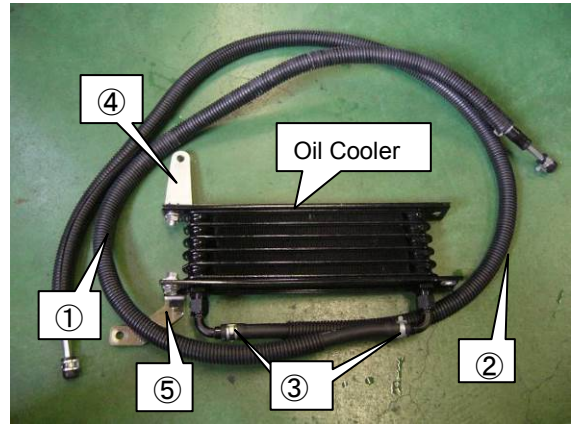

(11) Remove bolts ① and ②, and install the Oil Cooler Assy to the vehicle.
※Only for a JDM vehicle.

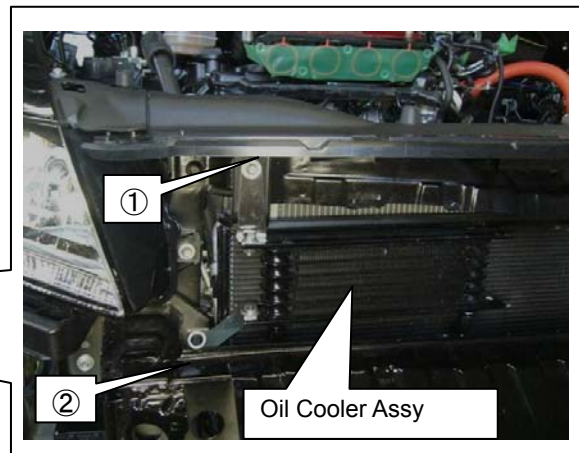
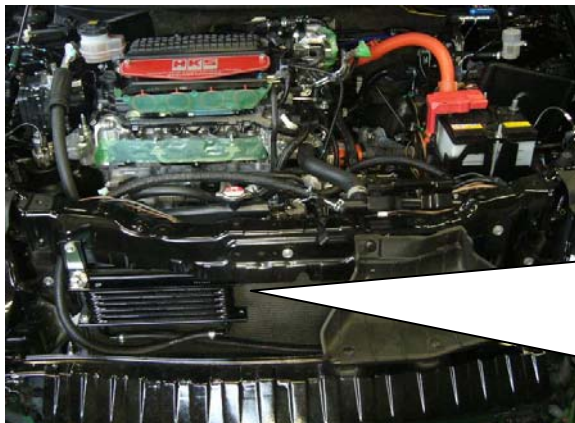

(12) Remove the factory bolt ① and ②. Install Traction Oil Cooler Assembly to the vehicle using the following parts:

- ①Removed Factory Bolt
- ③Hexagon Bolt M8 L=30
- ④Washer M8
- ⑤Spacer M8 L=10

※This procedure is required only to install this kit to a USDM vehicle.

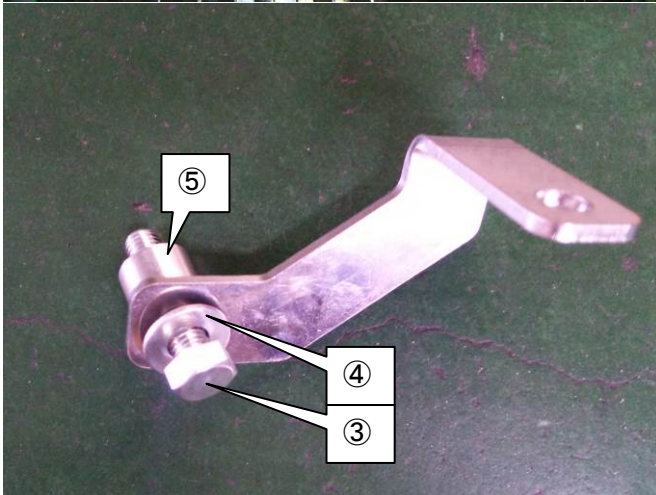
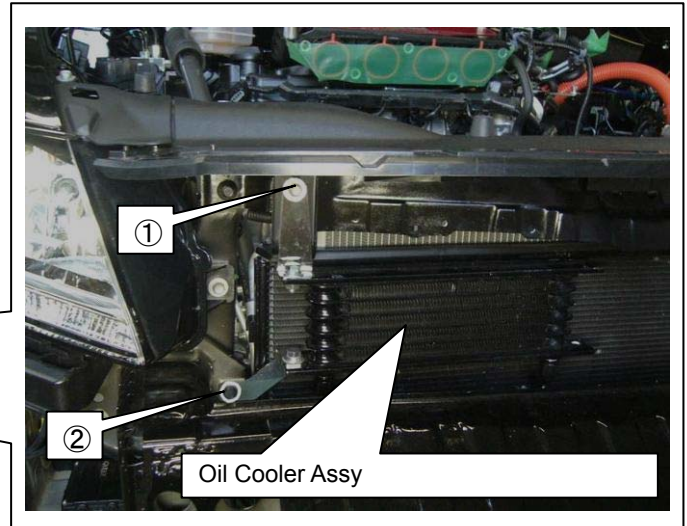
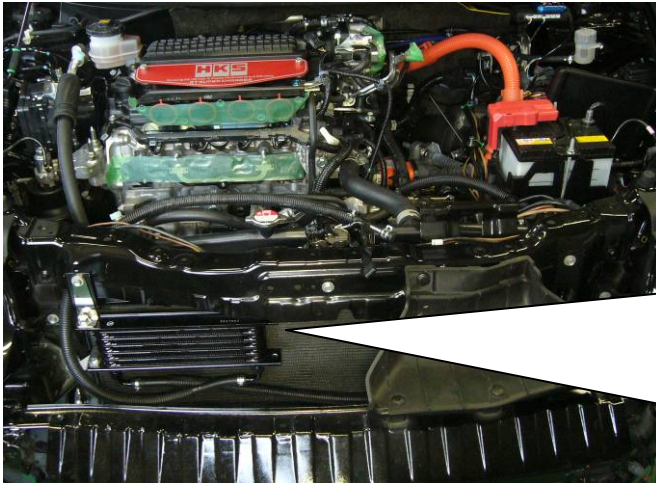

(13) Pull the 1000mm Hose 8mm ① and the 1250mm Hose 8mm ② from the both ends of the A/C condenser to the engine room.

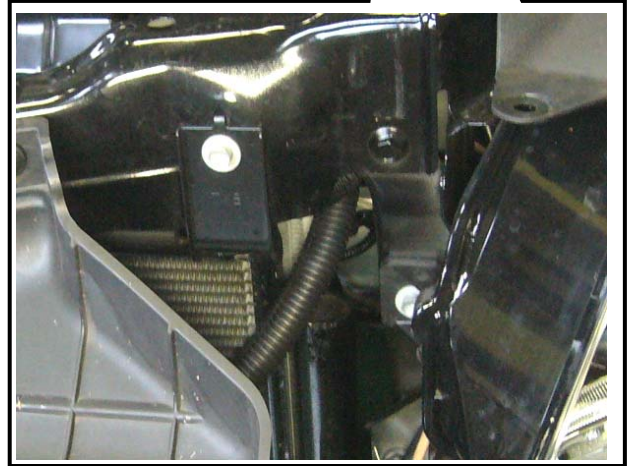
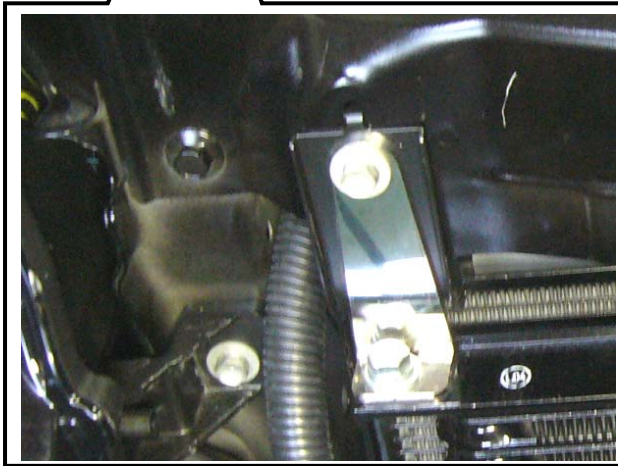
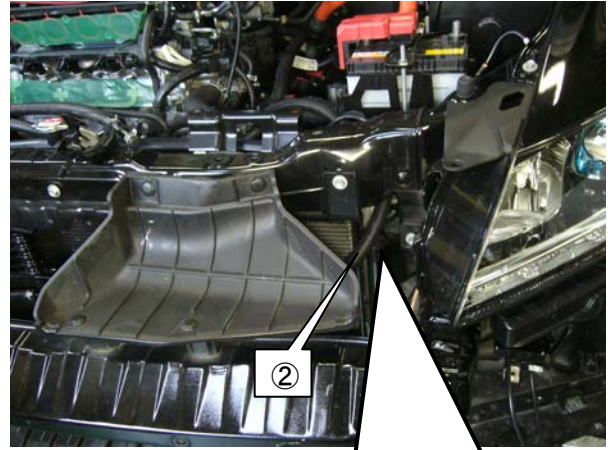
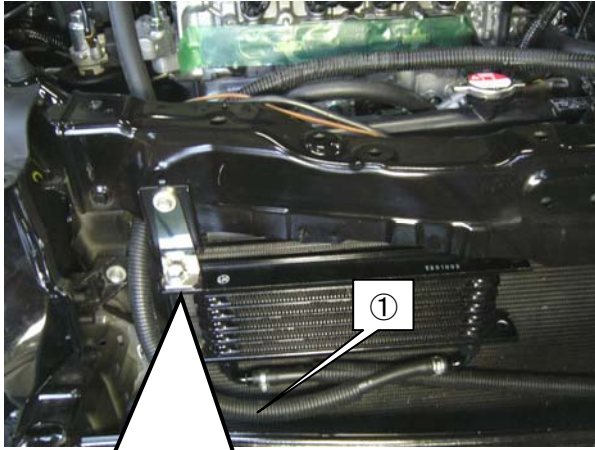

(14) Secure the Hose 8mm to ① using Tie Wraps as shown in the diagram so the hose does not come in contact with other parts of the vehicle.

NOTE

- Secure the hose at other locations using tie wraps if necessary.

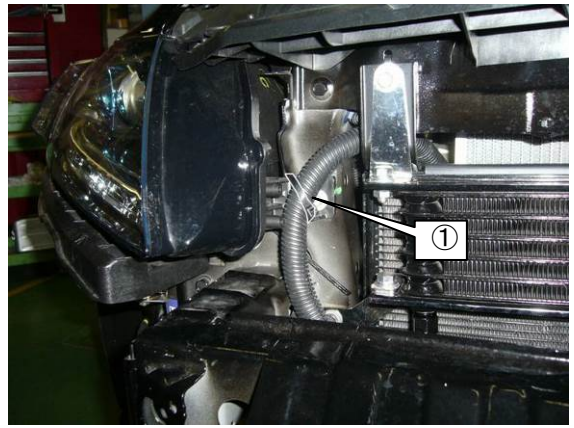

(15) Connect the 1250mm Hose 8mm ① to the Oil Tank using the 8mm Hose Clip ②.

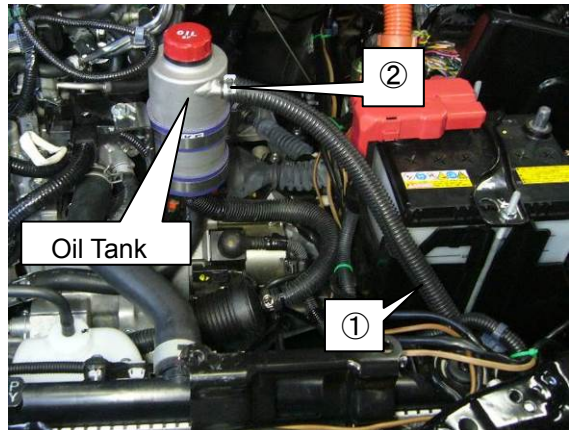

(16) Secure the Hose 8mm to ① using the Tie Wrap as shown in the diagram so the hose does not come in contact with other parts of the vehicle.

NOTE

- Secure the hose at other locations using tie wraps if necessary.

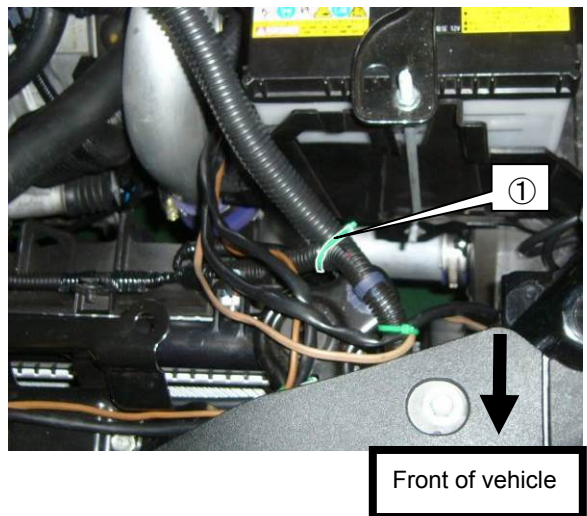

3. Installation of GT Supercharger

Parts List

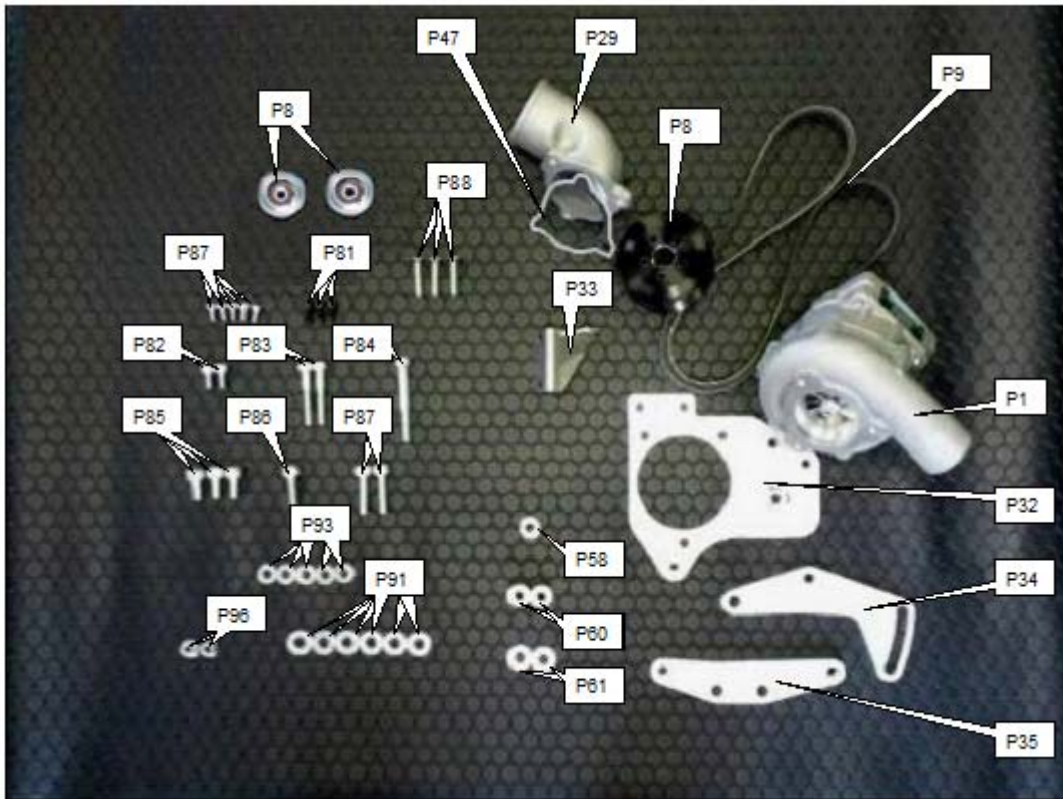

No.	Description	QT
P1	Supercharger Assy	1
P7	Pulley 60mm	2
P8	Supercharger Pulley	1
P9	Belt	1
P29	Suction Pipe No.1	1
P32	Supercharger Bracket No.1	1
P33	Supercharger Bracket No.2	1
P34	Tensioner Bracket No.1	1
P35	Tensioner Bracket No.2	1
P47	Suction Pipe Gasket	1
P58	Spacer M8 L=3.5	1
P60	Spacer M8 L=25	2
P61	Spacer M10 L=4	2
P80	Cap Bolt M6 L=12	5
P81	Cap Bolt M6 L=15	3
P82	Cap Bolt M8 L=15	2
P83	Cap Bolt M8 L=50	2

P84	Cap Bolt M8 L=70	1
P85	Cap Bolt M10 L=20	2
P86	Cap Bolt M10 L=35	3
P87	Cap Bolt M10 L=45	1
P88	Flat Head Bolt M8 L=35	3
P93	Washer M8	5
P94	Washer M10	6
P96	Flange Nut M8	2

(1) Install Pulley 60mm to Supercharger Bracket No.1 using the following parts:

- ① Cap Bolt M10 L=45
- ② Washer M10
- ③ Spacer M10 L=4

Torque Spec. N·m(kgf·m)
T=43(4.38)

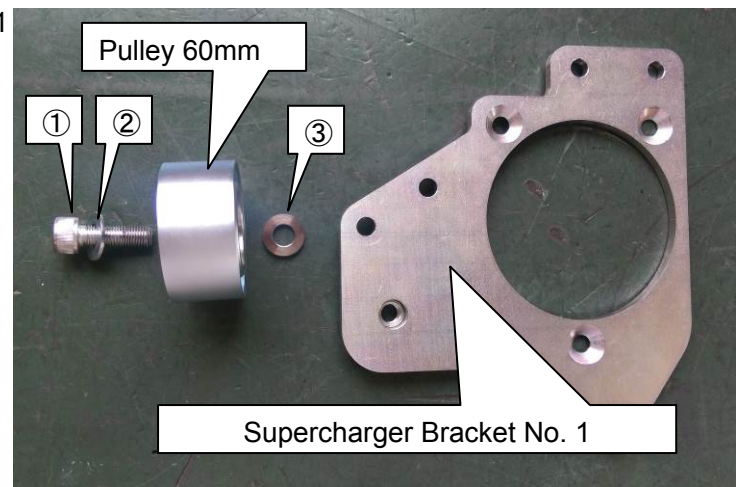

NOTE

•Make sure to install the pulley in a correct direction. The side with a snap ring must face up as shown in the diagram on the right.

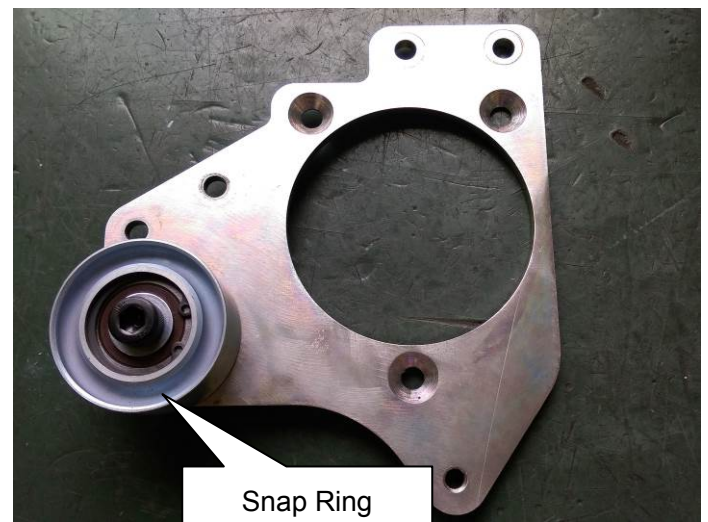

(2) Install Supercharger Bracket No.1 to the engine using the flowing parts:

- ① Cap Bolt M8 L=70
- ② Cap Bolt M8 L=50
- ③ Washer M8
- ④ Spacer M8 L=25
- ⑤ Spacer M8 L=5

Torque Spec. N·m(kgf·m)

T=24(2.45)

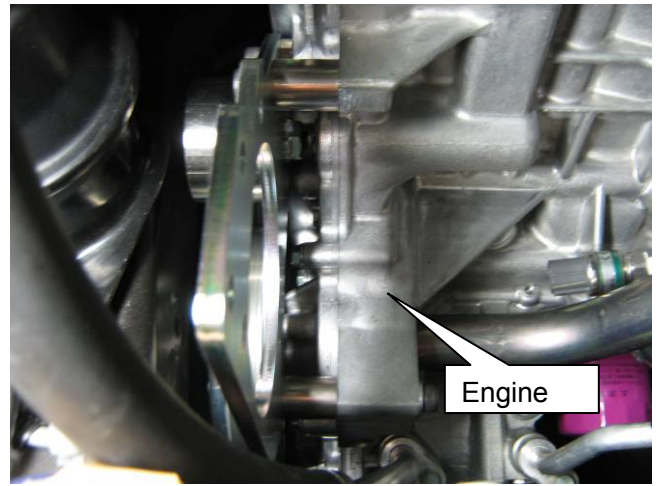
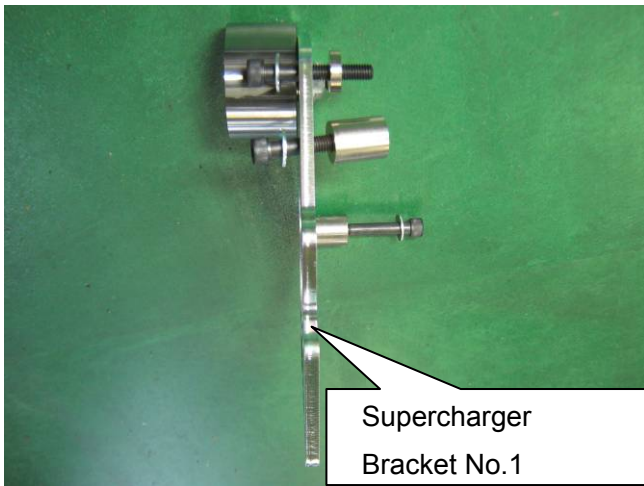
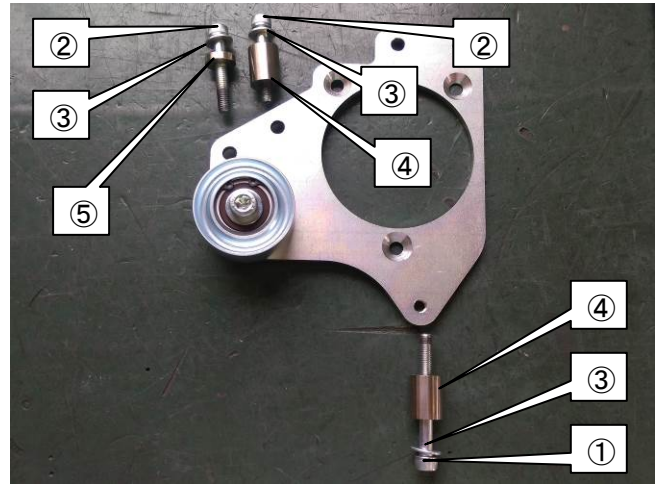

(3) Remove the factory engine oil level gauge. Cut the gauge as shown in the diagram on the right. Drill a hole on a tip and install the provided tie wrap to the hole to make a handle.



(4) Reinstall the modified factory engine oil level gauge back to the vehicle.

- (5) Loosen ① compressor housing fixing bolt of the Supercharger unit to loosen ② compressor housing fixing plate.

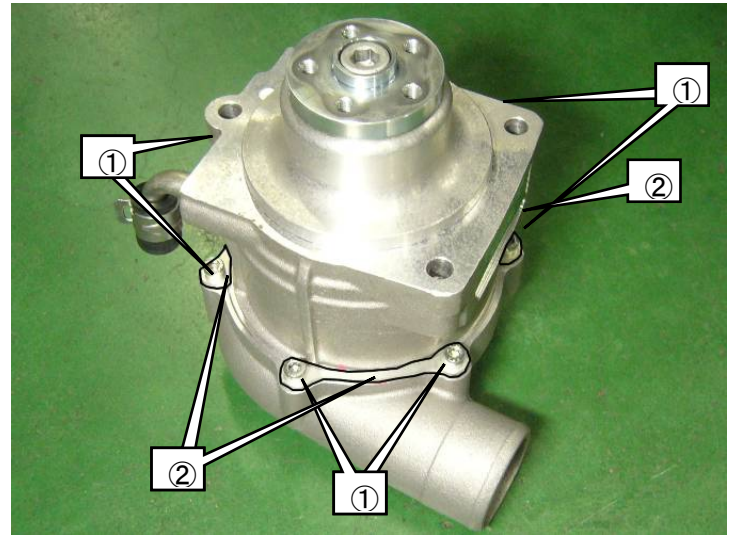

- (6) Rotate the Supercharger unit and ③ compressor Housing, and adjust the angle of the Supercharger Assy and compressor housing until there is 12mm gap between ④ the center line of the Supercharger Assy plate's both ends and ⑤ the center line of the compressor housing fixing bolt as shown in the diagram below. Retighten ① compressor housing fixing bolt and ② compressor housing fixing plate.

NOTE

• After adjusting the angles of the Supercharger Assy and the compressor housing, temporarily install the Supercharger Assy and the factory intake manifold to the vehicle; then temporarily install the suction pipe. Make sure the pipe does not come in contact with any other parts of the vehicle. Readjust the angle if necessary.

Torque Spec. N·m(kgf·m) T=5(0.51)

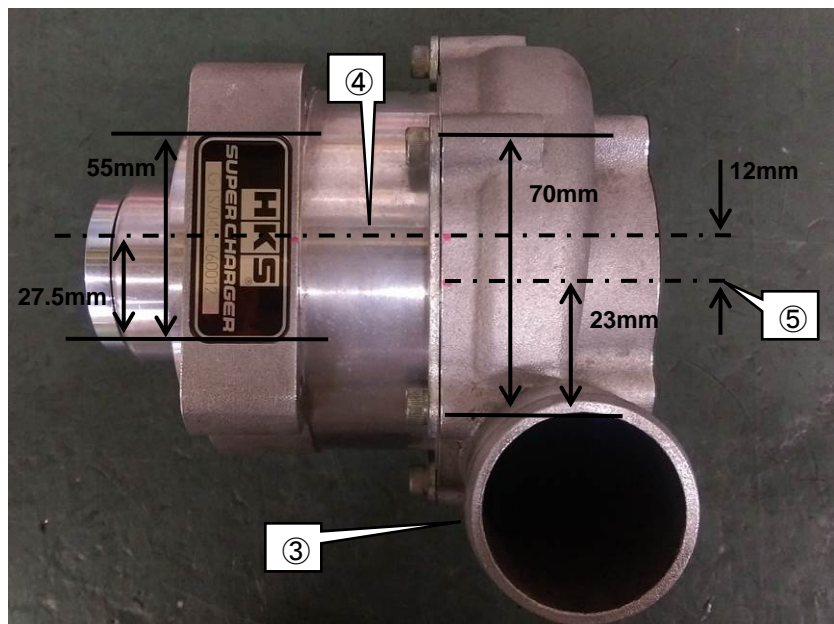

- (7) Remove the rubber cap and hose clip from the Supercharger Assy. Install ①Hose 8mm L=1000 and ②Hose 10mm L=570 to the Supercharger Assy using ③Hose Clip 8mm and ④Hose Clip 10mm removed from the Supercharger Assy.

NOTE

- Place a buffer material on the radiator core support, and put the Supercharger Assy on it as shown in the diagram below.
- Route the Hose 10mm L=570 underneath of the radiator upper hose and A/C discharge hose to connect to the Supercharger Assy.
- Route the Hose 8mm L=1000 underneath of the Hose 10mm L=570 when installing the Supercharger Assy to the vehicle.

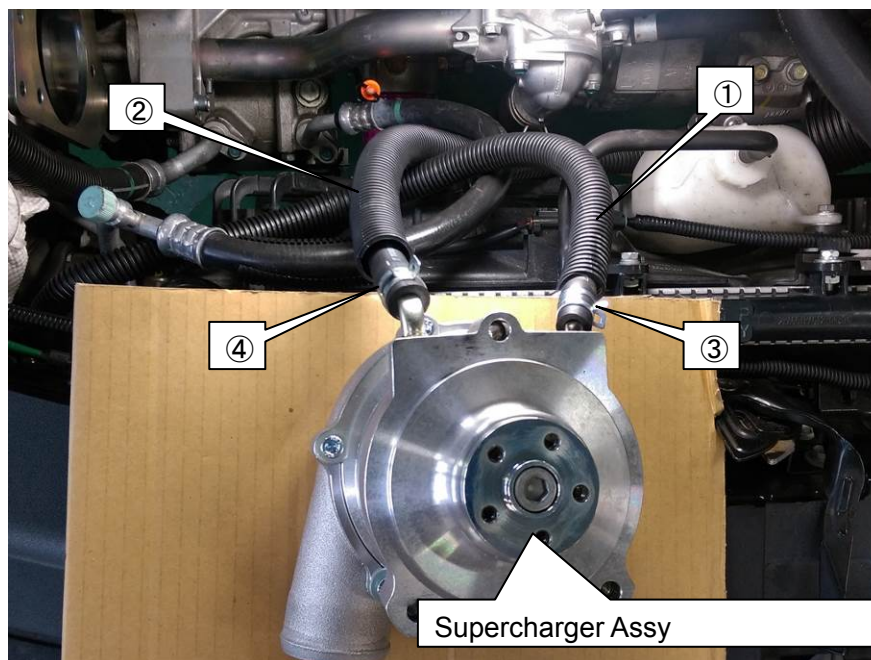
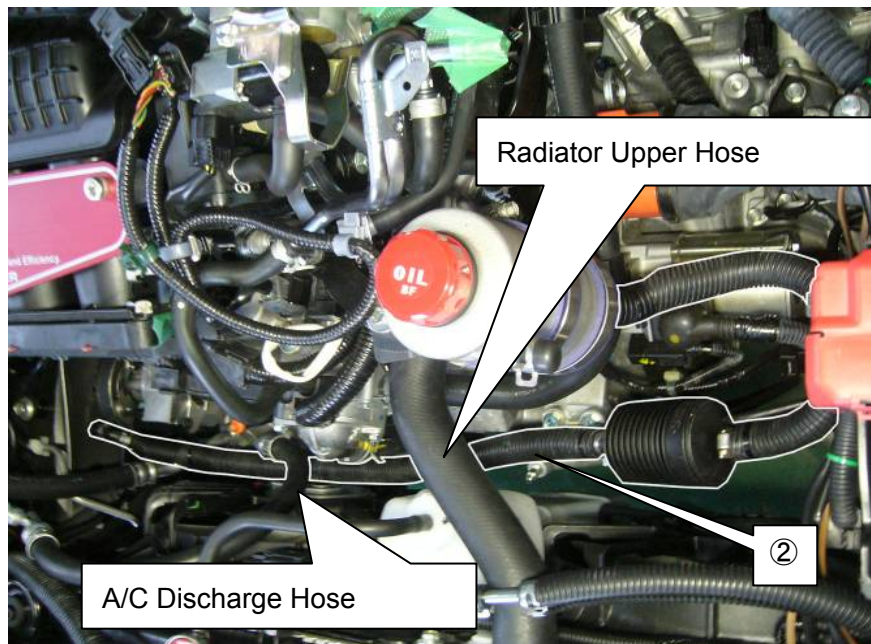

(8) Install the Supercharger Assy to Supercharger Bracket No.1 using ① Flat Head Bolt M8 L=35.

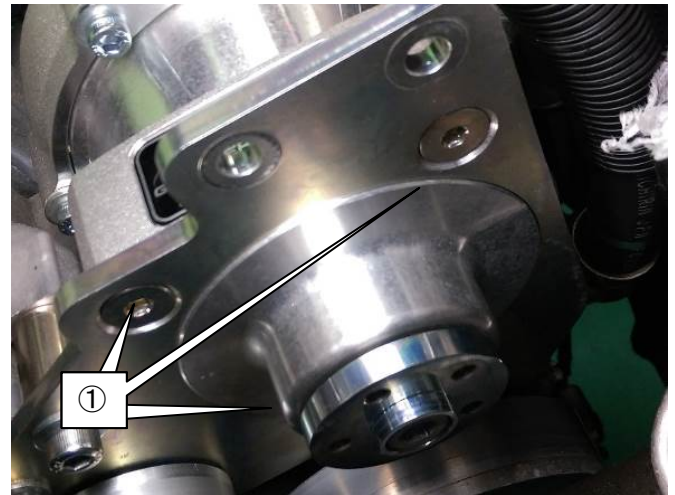

(9) Install the Supercharger Pulley to Supercharger Assy using ① Cap Bolt M6 L=12.

NOTE

- When tightening the hexagon part of the cap bolt, hold the bolt in the center of the pulley with a hexagon wrench so the center part of the Supercharger Assy does not rotate.

Torque Spec. N·m(kgf·m)

T=10(1.02)

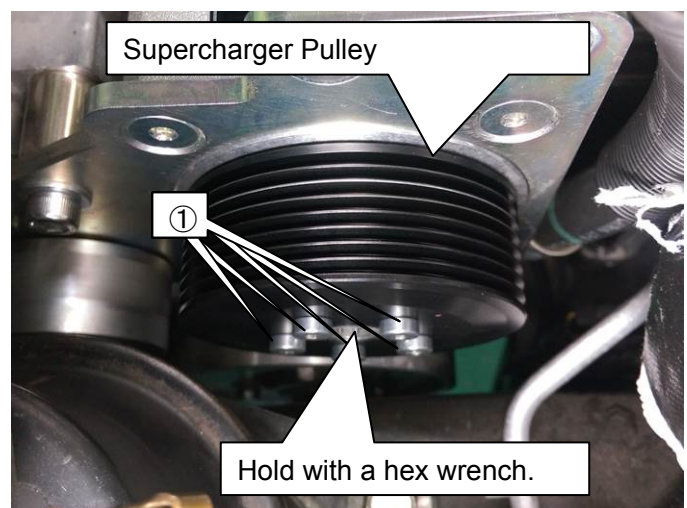
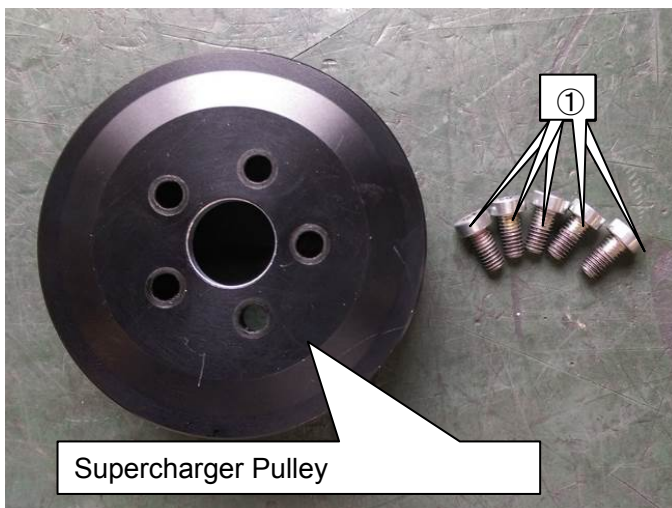

- (10) Install the Suction Pipe No.1 to the Supercharger Assy using ①Suction Pipe Gasket and ②Cap Bolt M6 L=15.

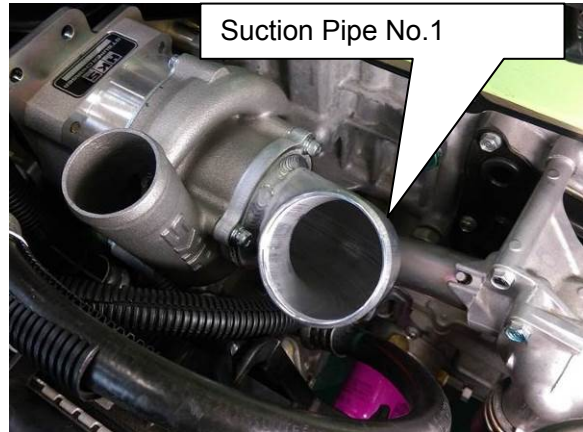
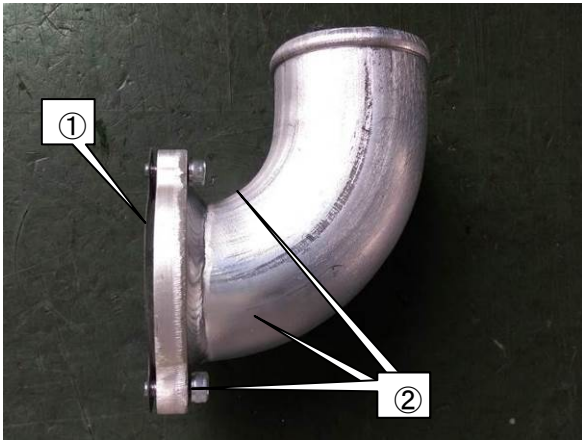

- (11) Reinstall the factory intake manifold, and install Supercharger Bracket No.2 using a factory bolt and the following parts.

- ① Cap Bolt M8 L=15
- ② Washer M8
- ③ Flange Nut M8

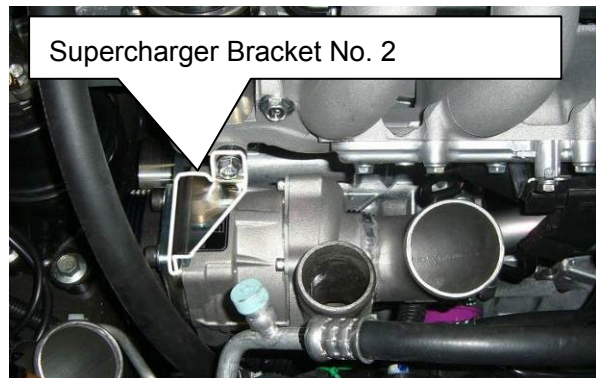
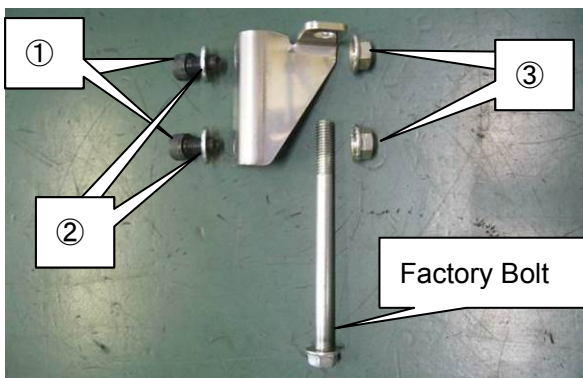

- (12) Modify the resin-made cover of the knock sensor harness, oil pressure sensor harness. Cut off the cover at the dotted line shown in the diagram below.

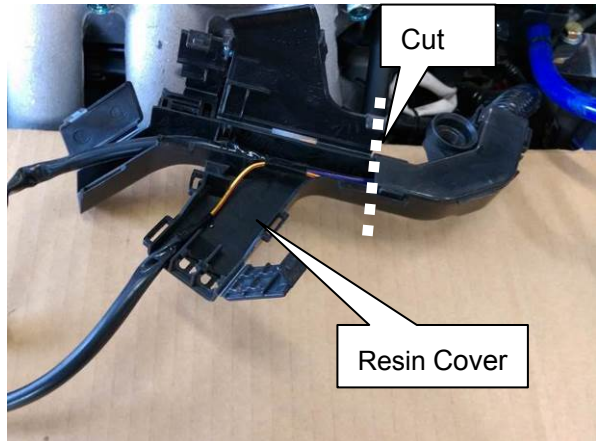
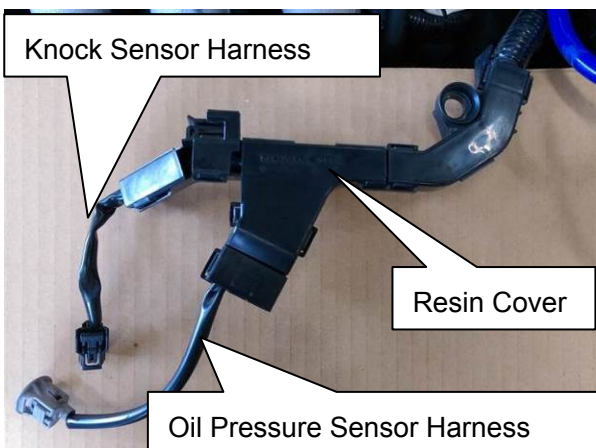

- (13) After cut off the resin-made cover, cover the knock sensor harness and oil pressure sensor harness with the provided ① Corrugated Tube for Sensor Wiring. Secure the harnesses using the factory bolt as shown in the diagram below.

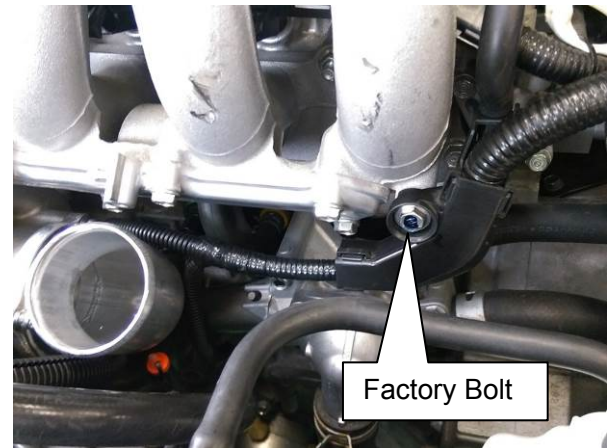
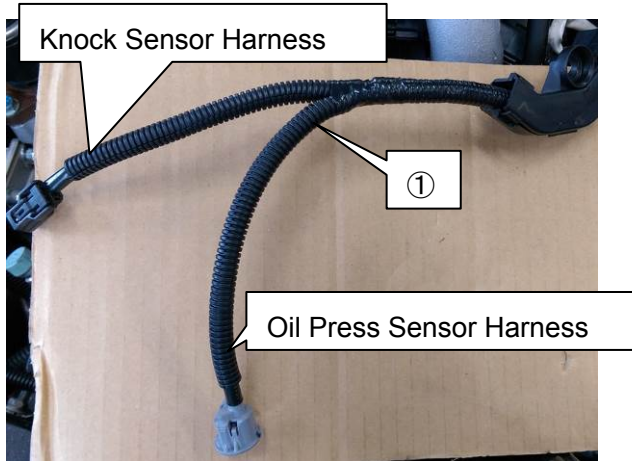

- (14) Secure the Traction Oil Hose 8mm and 10mm with Tie Wraps at ①-③ in the diagrams on the right and below so the hoses do not come in contact with any other parts of the vehicle.

NOTE

- Secure the hoses using Tie Wraps other than the specified points if necessary to make sure they do not come in contact with any other parts of the vehicle.

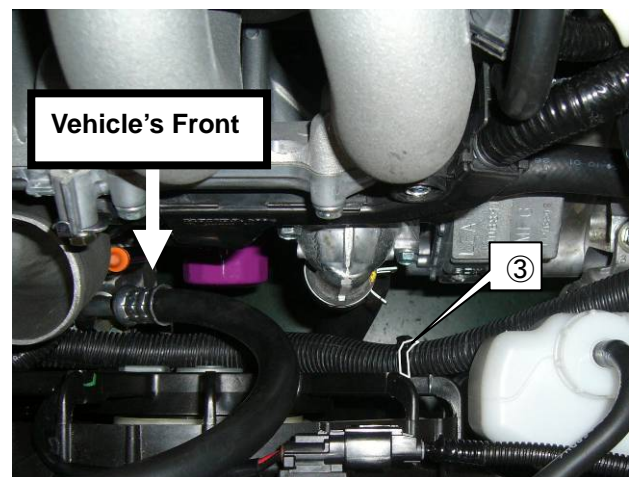
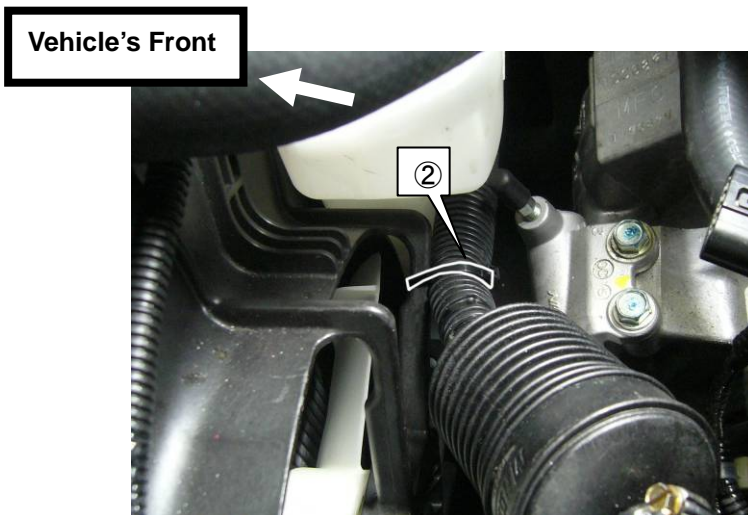
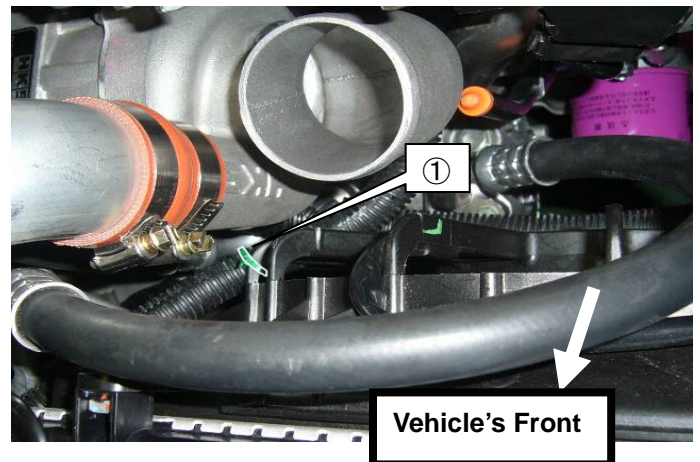

(15) Install Tensioner Bracket No.2 to the lower part of the engine using the following parts.

- ① Cap Bolts M10 L=35
- ② Washers M10

NOTE

•Make sure to install Tensioner Bracket No.2 in correct direction. Refer to the diagrams below.

Torque Spec. N·m(kgf·m) T=43(4.38)

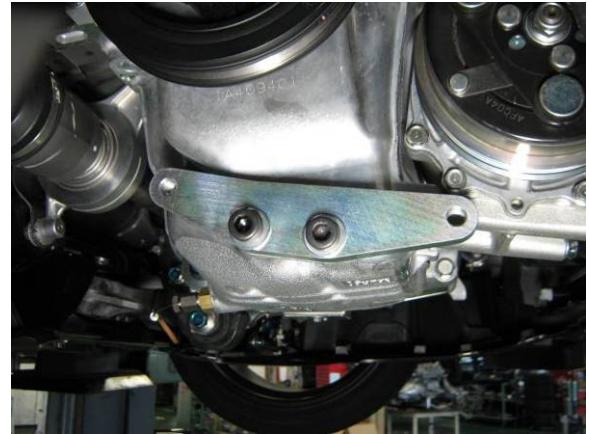
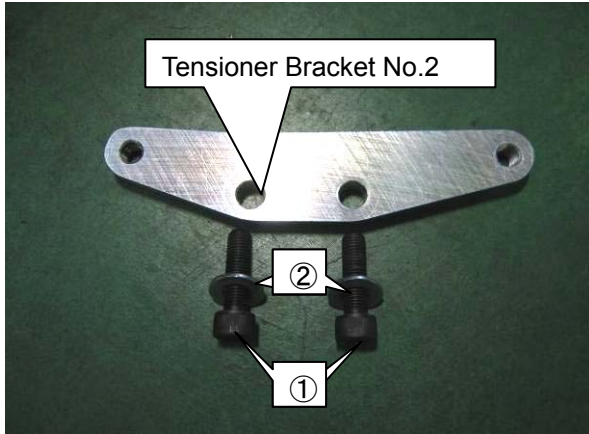

(16) Install the Pulley 60mm to Tensioner Bracket No.1 using the following parts.

- ① Cap Bolt M10 L=35
- ② Washer M10
- ③ Spacer M10 L=4

Torque Spec. N·m(kgf·m) T=35(3.57)

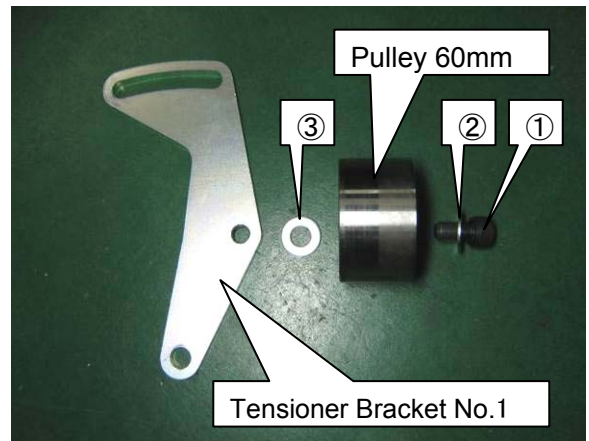

(17) Select the appropriate ribbed belt referring to the application list on page 1. Route the belt as shown in the diagram below.

NOTE

- For easier installation of the belt, rotate the factory crank pulley clockwise while installing.
- Since HKS Supercharger Pulley is 8-rib, the belt install the belt to the 4-rib on the driver's side.

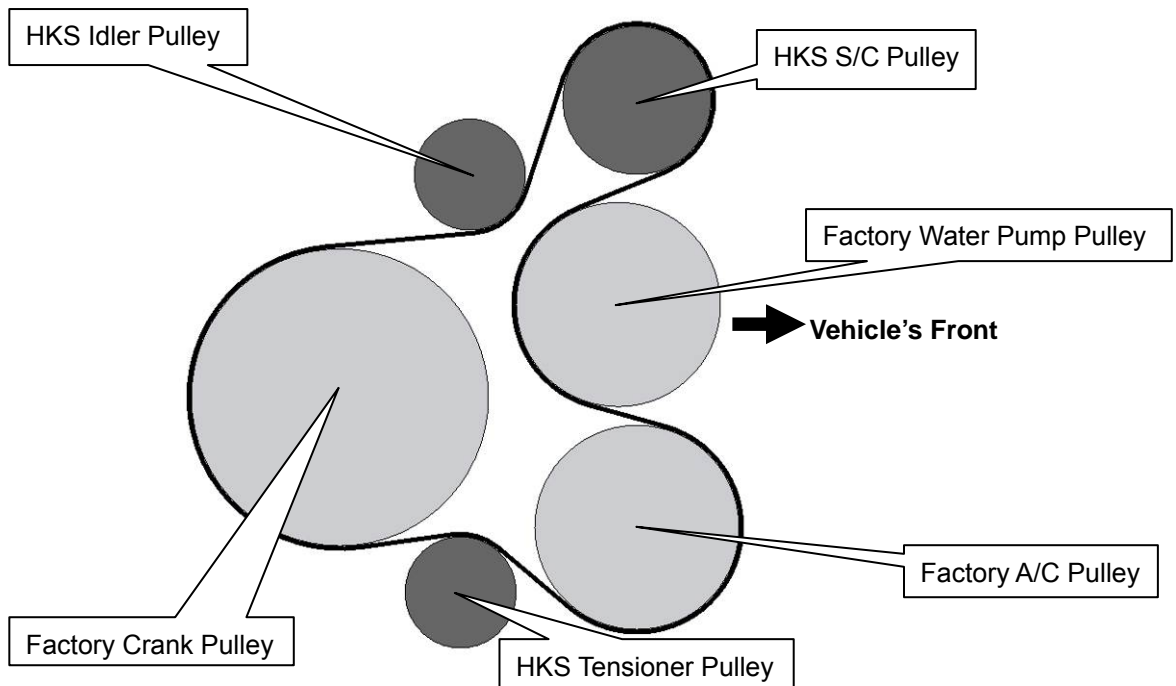

(18) Install Tensioner Bracket No.1 to Tensioner Bracket No.2 using the following parts.

- ① Cap Bolts M10 L=20
- ② Washers M10

Move Tensioner Bracket No.1 up and down to adjust the belt tension to the indicated specification.

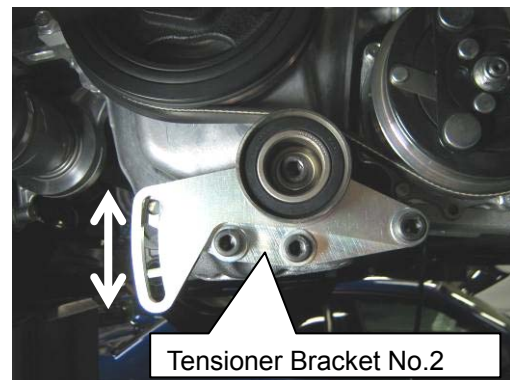
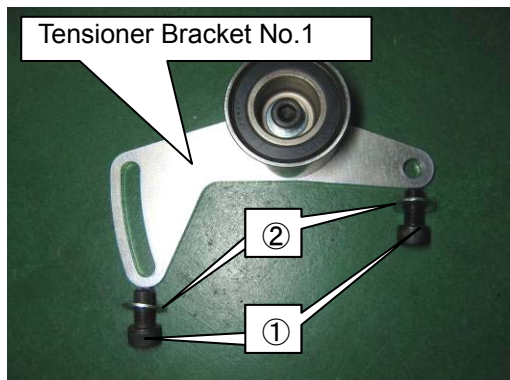

Measurement Position	Belt Span※	Belt Tension (N{kg})
Between Idler Pulley & Crank Pulley	130mm	650{66.3}

※ Input the belt span value to the measuring instrument when measuring the tension.

NOTE

- After installing the belt and adjusting it to the specified belt tension, rotate the crankshaft a few times and readjust the belt tension.
- The belt tension will settle between 2-20 hours after installation. Once the belt settles, re-measure the tension and adjust if necessary. Periodically check the belt tension to make sure it's up to specification.
- Make sure the belt is correctly aligned with the grooves on the pulley.

Torque Spec. N·m(kgf·m) T=43(4.38)

4. Installation of Intercooler and Piping

- Installation of Intercooler

Parts List

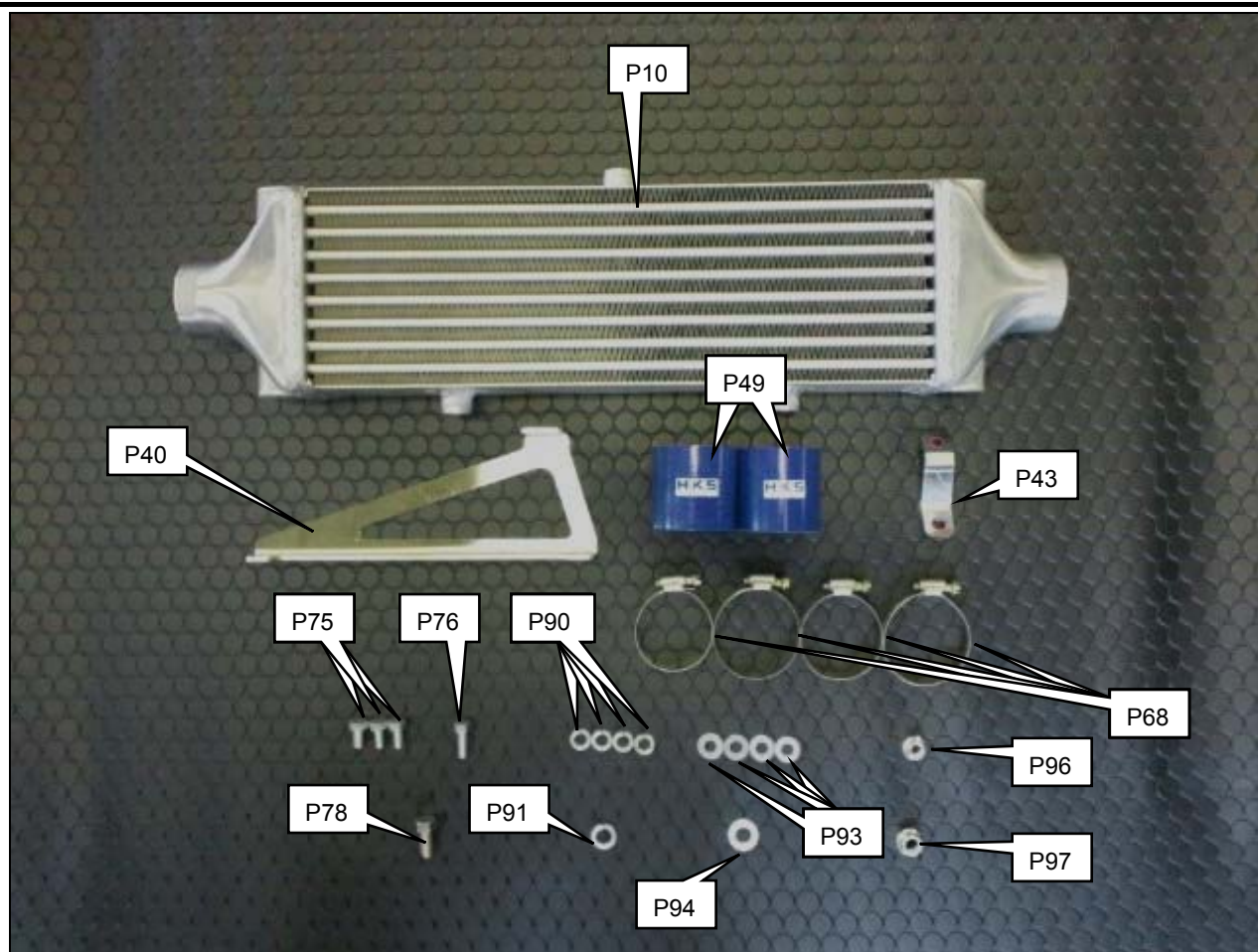

No.	Description	QT
P10	Intercooler	1
P40	Oil Cooler Bracket No.3	1
P43	Intercooler Bracket	1
P49	Silicone Hose 50mm L=55	2
P68	Hose Clamp #28	4
P75	Hexagon Bolt M8 L=15	3
P76	Hexagon Bolt M8 L=20	1
P78	Hexagon Bolt M10 L=20	1
P90	Lock Washer M8	4
P91	Lock Washer M10	1
P93	Washer M8	4
P94	Washer M10	1
P96	Flange Nut M8	1
P97	Flange Nut M10	1

(1) Remove the factory horn (LO). Install the removed factory horn (LO) together with the factory horn (HI).

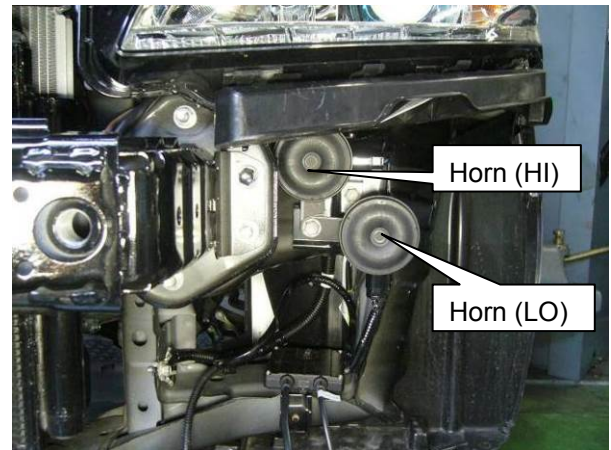
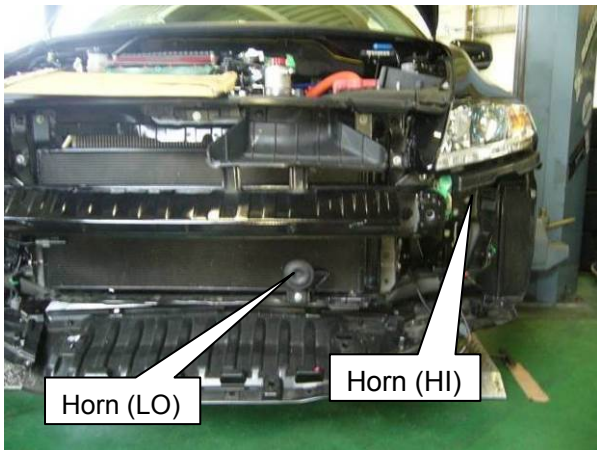

(2) Temporarily install Oil Cooler Bracket No.3 to the Intercooler using the following parts.

- ① Hexagon Bolts M8 L=15
- ② Lock Washers M8
- ③ Washers M8

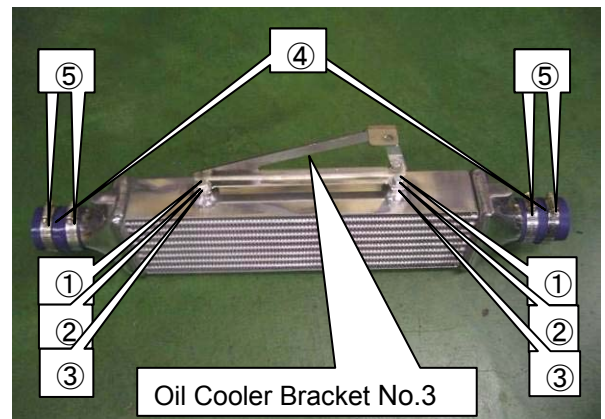

(3) After installing the bracket, install the Silicone Hoses 50mm L=55 ④ to the Intercooler using the Hose Clamps #28 ⑤.

(4) Temporarily install the Intercooler Bracket to the vehicle using the following parts.

- ① Hexagon Bolt M10 L=20
- ② Lock Washer M10
- ③ Washer M10
- ④ Flange Nut M10

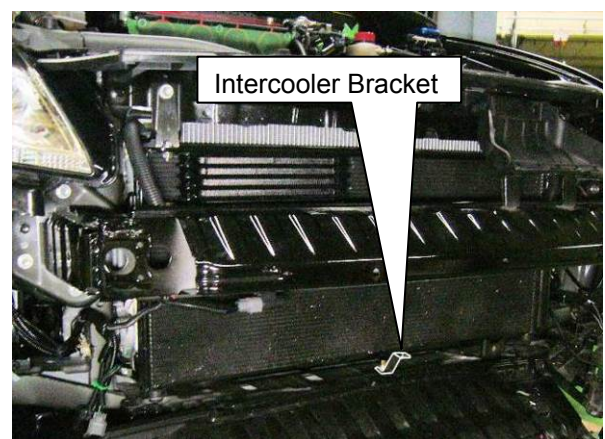
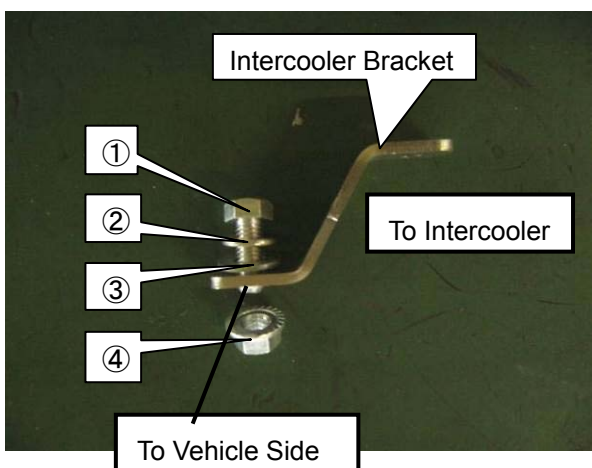

(5) Temporarily install the Intercooler Assy to the oil cooler using the following parts.

- ① Hexagon Bolt M8 L=20
- ② Lock Washer M8
- ③ Washer M8
- ④ Flange Nut M8

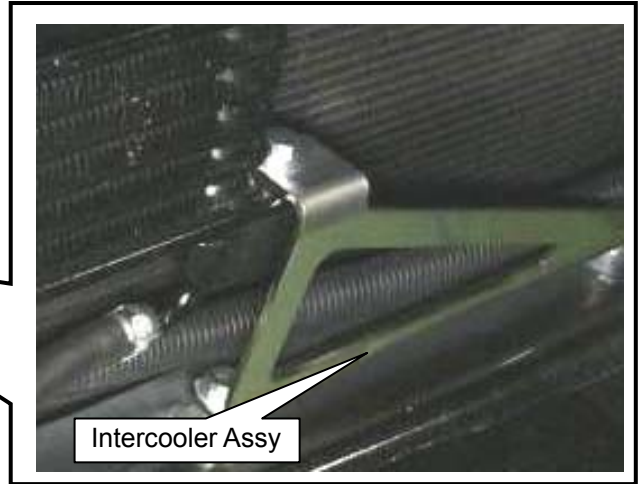
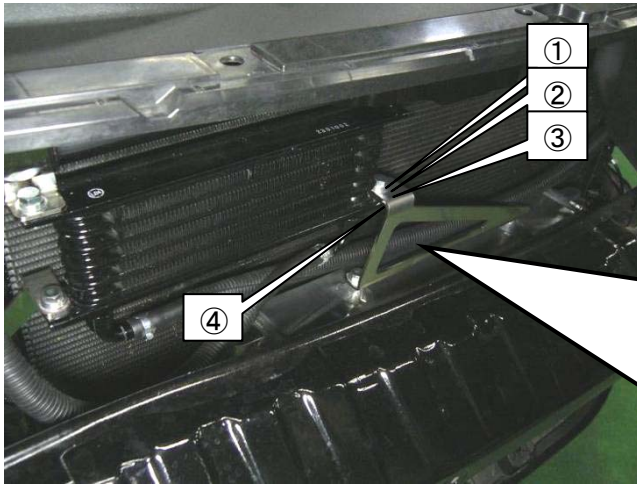

(6) After properly adjusting the position of the Intercooler Assy with enough clearance from surrounding parts, and install the Intercooler Assy to the vehicle using the following parts.

- ① Hexagon Bolt M8 L=15
- ② Lock Washer M8
- ③ Washer M8

Tighten all bolts and nuts temporarily installed.

NOTE

- Make sure the bottom intercooler mount (offset) is towards the vehicle side.

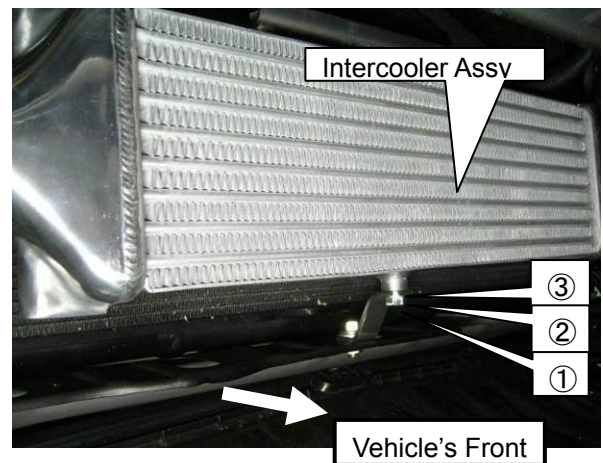

(7) Secure the Hose 8mm to ① in the diagram using tie wraps so the hose does not come in contact with any other parts of the vehicle.

NOTE

- Secure the hose at other locations using tie wraps if necessary.

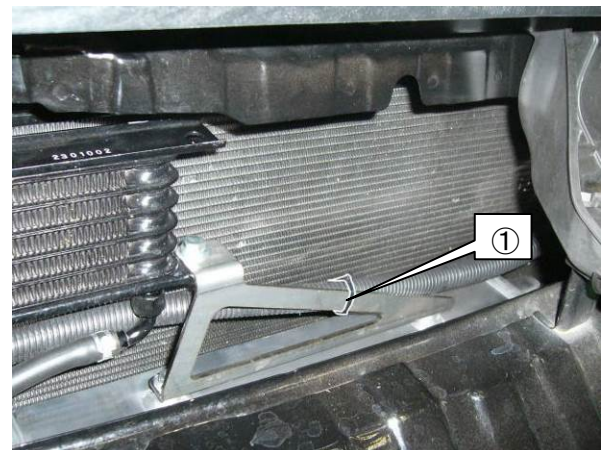

• Installation of Intercooler Inlet Pipe

Parts List

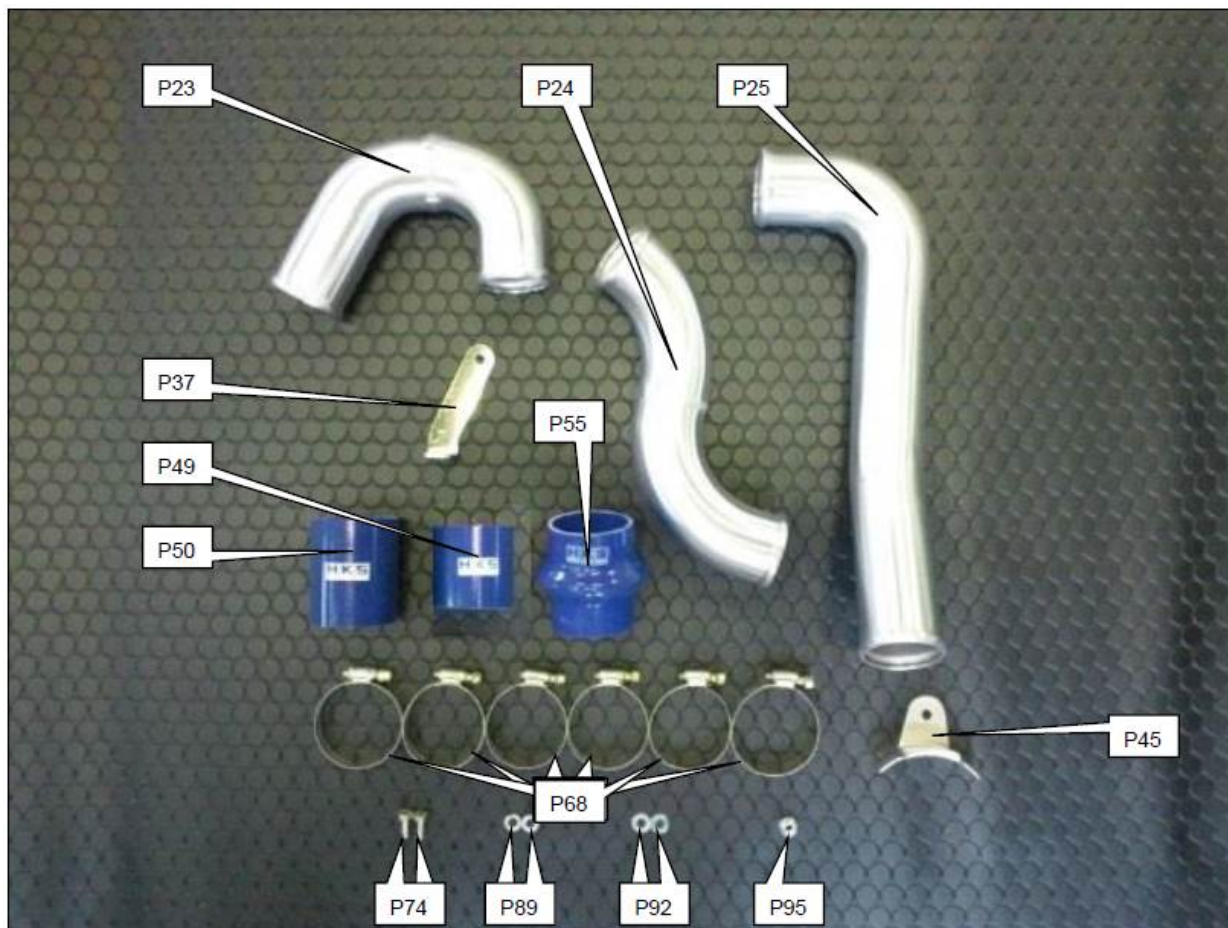

No.	Description	QT
P23	Intercooler Inlet Pipe No.1	1
P24	Intercooler Inlet Pipe No.2	1
P25	Intercooler Inlet Pipe No.3	1
P37	Intercooler Inlet Pipe Bracket	1
P45	Universal Pipe Bracket 50mm	1
P49	Silicone Hose 50mm L=55	1
P50	Silicone Hose 50mm L=70	1
P55	Cushion Hose 50mm L=75	1
P68	Hose Clamp #28	6
P74	Hexagon Bolt M6 L=15	2
P89	Lock Washer M6	2
P92	Washer M6	2
P95	Flange Nut M6	1

(8) Temporarily install the Intercooler Inlet Pipe Bracket (8) to Intercooler Inlet Pipe No.2 using the following parts.

- ① Silicone Hose 50mm L=70
- ② Universal Pipe Bracket 50mm
- ③ Hose Clamp #28
- ④ Hexagon Bolt M6 L=15
- ⑤ Lock Washer M6
- ⑥ Washer M6
- ⑦ Flange Nut M6

Install the Cushion Hose 50mm (9) and Hose Clamp #28 (10) to the pipe.

NOTE

• Make sure to install the Intercooler Inlet Pipe Bracket to the correct side of Intercooler Inlet Pipe No.2 referring to the diagram on the right.

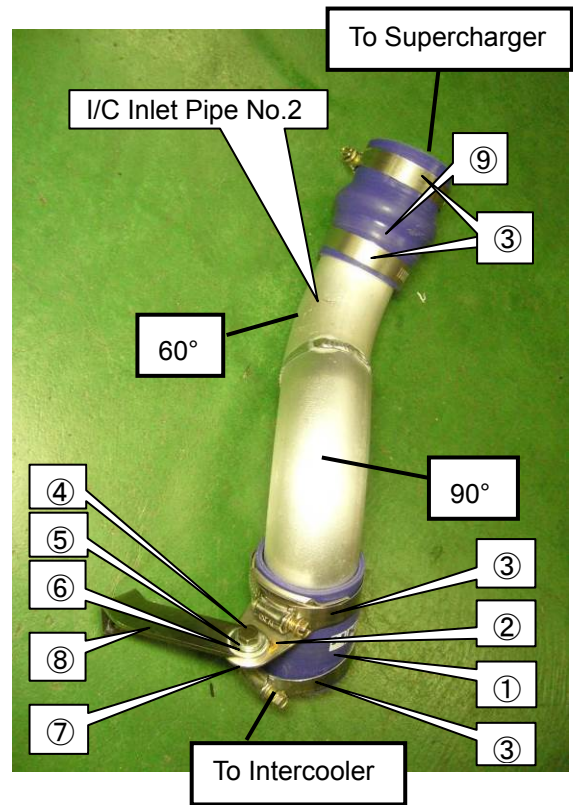

(9) Temporarily install Intercooler Inlet Pipe No.2 to the vehicle using the following parts.

- ① Hexagon Bolt M6 L=15
- ② Lock Washer M6
- ③ Washer M6

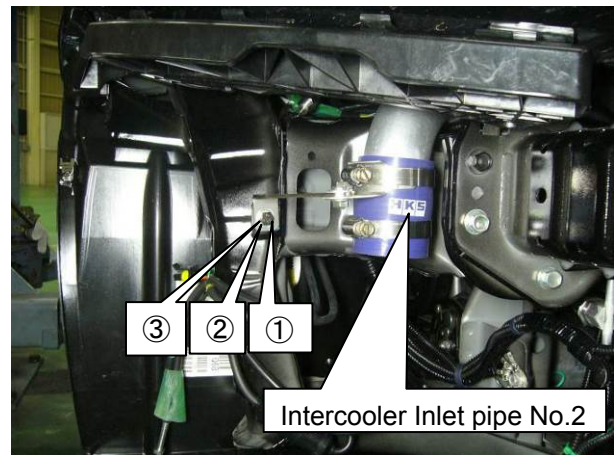

(10) Temporarily install Intercooler Inlet Pipe No. 3 to the vehicle.

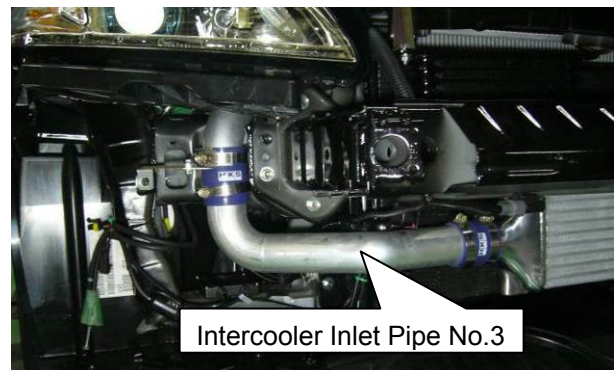

(11) Temporarily install Intercooler Inlet Pipe No.1 to the vehicle using ①Silicone Hose 50mm L=55 and ②Hose Clamps #28. After properly adjusting the positions of Intercooler Inlet Pipe No.1, 2 and 3, tighten all bolts and hose clamps temporarily installed.

NOTE

- Cut and affix the sponge sheet to locations on the pipe(s) that may come in contact with other parts of the vehicle.

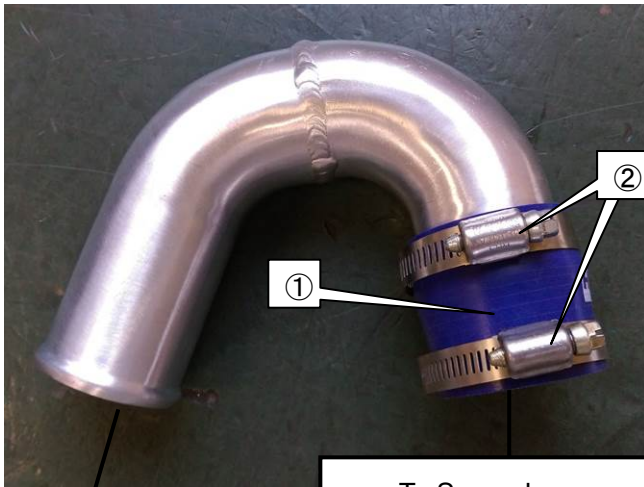

To Supercharger

To Intercooler Inlet Pipe No.2



Intercooler Inlet Pipe No.1

• Installation of Intercooler Outlet Pipe

Parts List

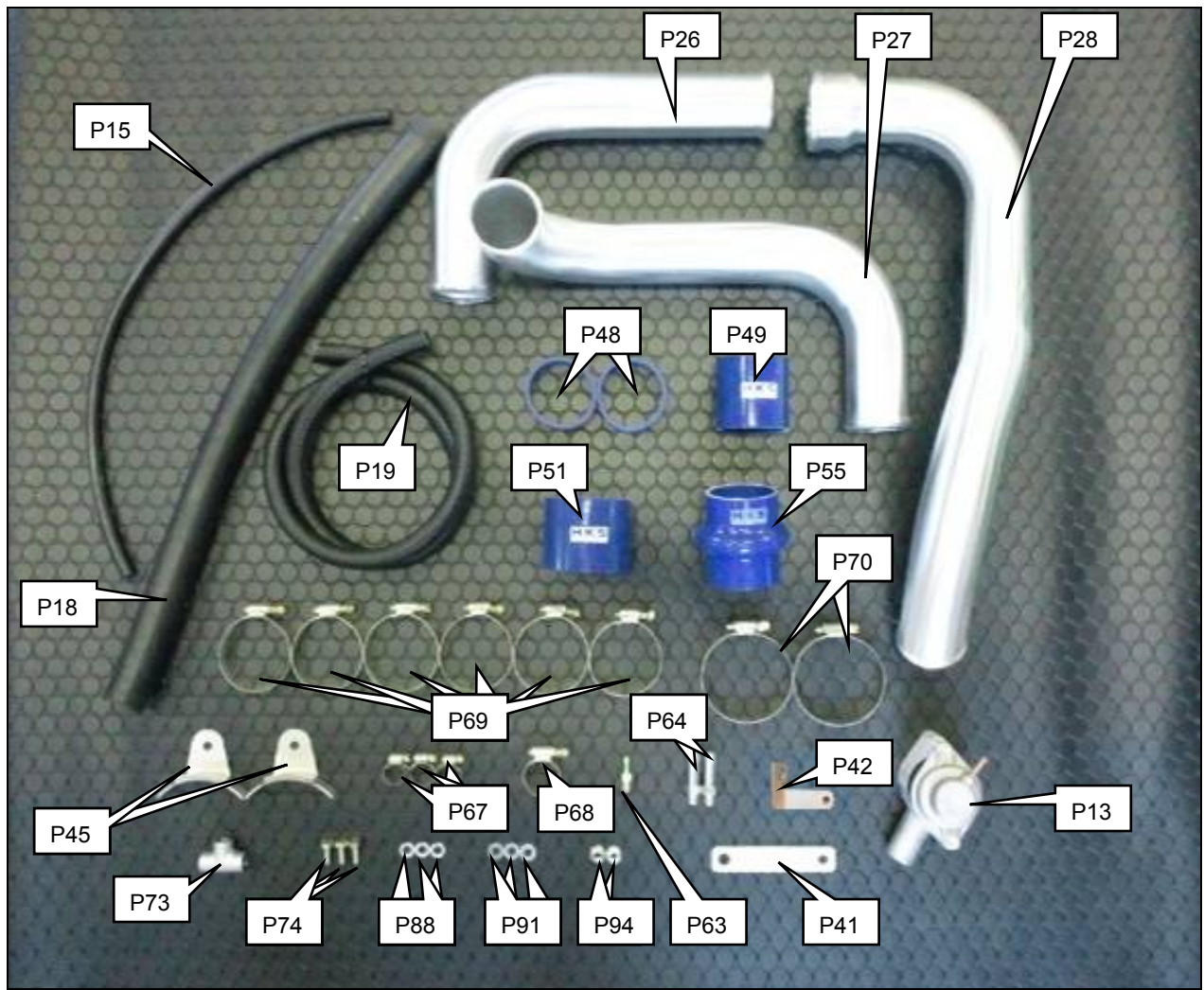

No.	Description	QT
P12	Bypass Valve Assembly	1
P14	Hose 4mm	1
P17	Hose 22mm	1
P18	Oil Resistant Hose 10mm	1
P26	Intercooler Outlet Pipe No.1	1
P27	Intercooler Outlet Pipe No.2	1
P28	Intercooler Outlet Pipe No.3	1
P41	Intercooler Outlet Pipe Bracket No.1	1
P42	Intercooler Outlet Pipe Bracket No.2	1
P45	Universal Pipe Bracket 50mm	2
P48	Silicone Hose 50mm L=20	2
P49	Silicone Hose 50mm L=55	1
P51	Silicone Hose 60mm L=55	1
P55	Cushion Hose 50mm L=75	1
P62	Hose Fitting 4mm	1
P63	Hose Fitting 10mm	2

P66	Hose Clamp #4	3
P67	Hose Clamp #16	1
P68	Hose Clamp #28	6
P69	Hose Clamp #36	2
P72	3-way Connector PT1/8	1
P73	Hexagon Bolt M6 L=15	3
P89	Lock Washer M6	3
P92	Washer M6	3
P95	Flange Nut M6	2

(12) Temporarily install Intercooler Outlet Pipe No.1 to the vehicle.

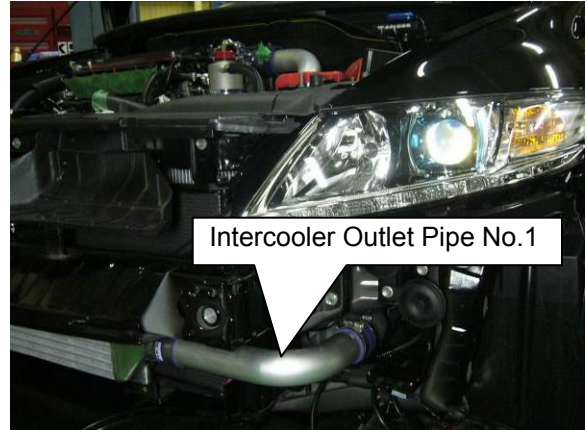

(13) Temporarily install ⑧ Intercooler Outlet Pipe Bracket No.1 to Intercooler Outlet Pipe No.2 using the following parts.

- ① Silicone Hose 50mm L=20
- ② Universal Bracket 50mm
- ③ Hose Clamp #28
- ④ Hexagon Bolt M6 L=15
- ⑤ Lock Washer M6
- ⑥ Washer M6
- ⑦ Flange Nut M6

Install the following parts to the pipe: ⑨ Silicone Hose 50mm L=55, ⑩ Cushion Hose 50mm L=75, and ⑪ Hose Clamp #28

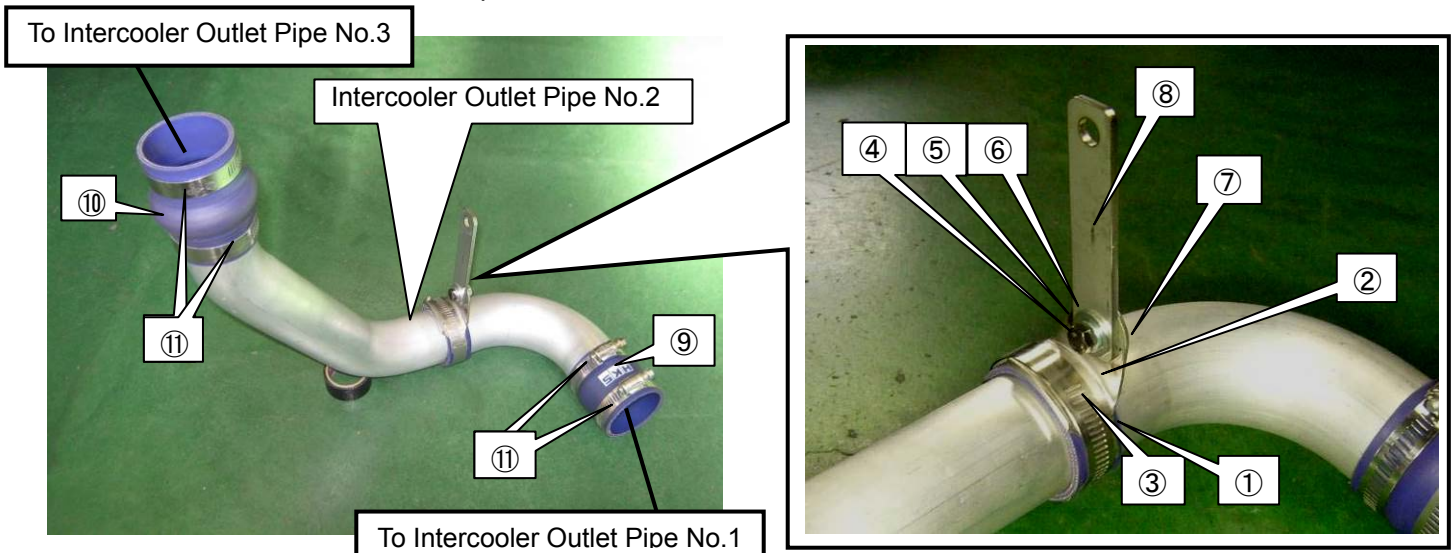

- (14) Remove the bolt ① in the diagram below, and temporarily install Intercooler Outlet Pipe No.2 to the vehicle.

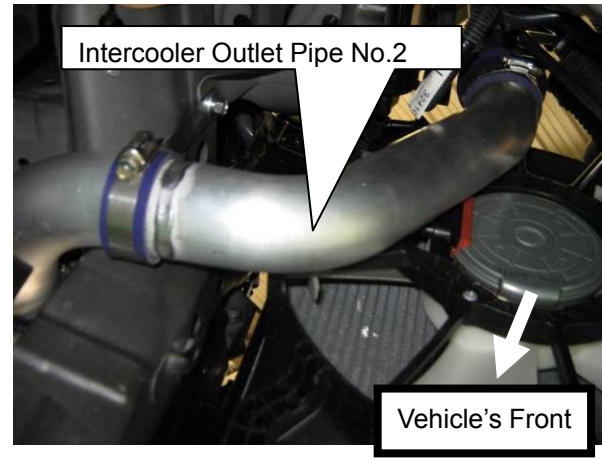
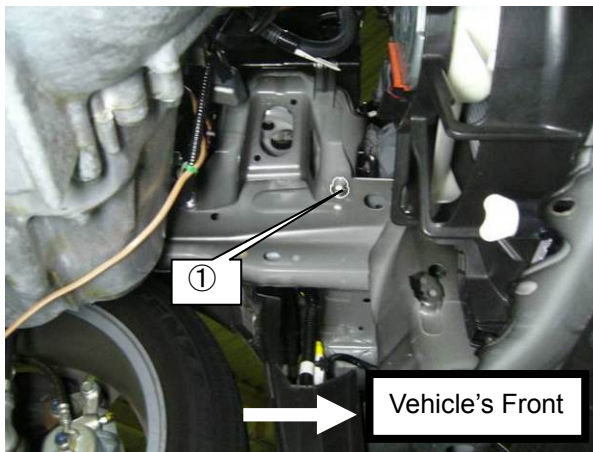

- (15) Insert the gasket of the Bypass Valve Assy and install the Bypass Valve Assy to ① Intercooler Outlet Pipe No.3.

- (16) Cut the Hose 22mm to 420mm in length.

- (17) Install ② Hose 22mm L=420mm and ③ Hose Clamp #16.

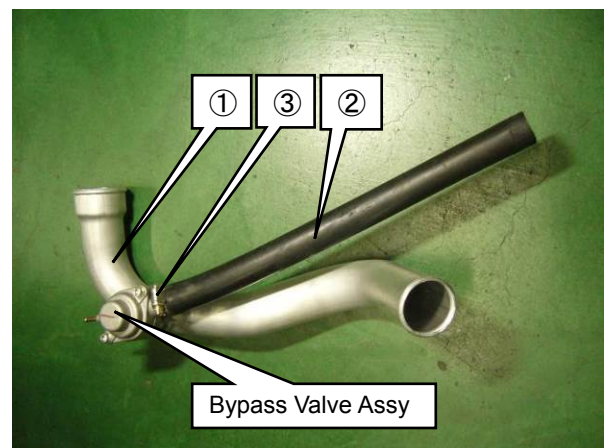
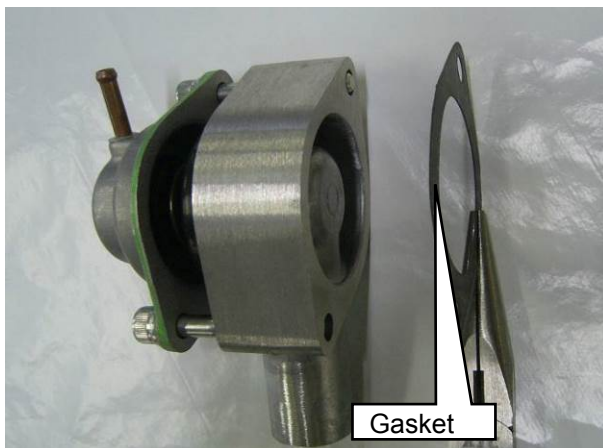

- (18) Temporarily install ⑧ Intercooler Outlet Pipe Bracket No.1 to Intercooler Outlet Pipe No.2 using the following parts.

- | | |
|------------------------------|------------------|
| ① Silicone Hose 50mm L=20 | ⑤ Lock Washer M6 |
| ② Universal Pipe Bracket 50m | ⑥ Washer M6 |
| ③ Hose Clamp #28 | ⑦ Flange Nut M6 |
| ④ Hexagon Bolt M6 L=15 | |

Install ⑨ Silicone Hose 60mm L=55 and ⑩ Hose Clamp #36 to the pipe.

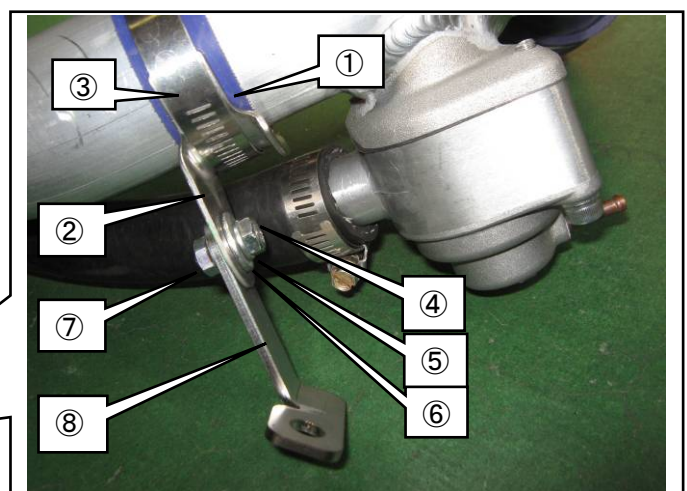
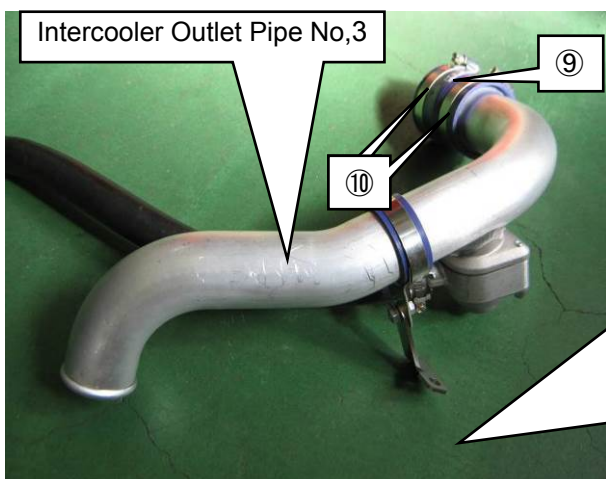

(19) Install Intercooler Outlet Pipe No.3 to the vehicle using the following parts.

- ① Hexagon Bolt M6 L=15
- ② Lock Washer M6
- ③ Washer M6

Determine the installation position of Intercooler Outlet Pipe No.1, 2, and 3.
Tighten all bolts and nuts temporarily installed.

NOTE

• Cut and affix the sponge sheet to locations on the pipe(s) that may come in contact with other parts of the vehicle.

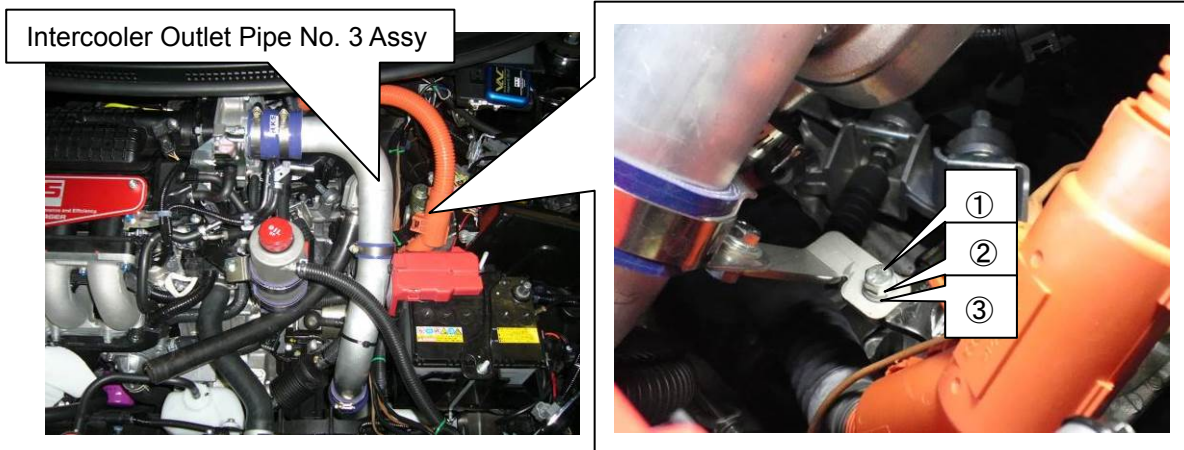

(20) Secure the Hose 8mm to ① using a tie wrap so the hose does not come in contact with other parts of the vehicle as shown the diagram on the right.

NOTE

- Secure the hose at other locations using tie wraps if necessary
- Make sure the hose does not get kinked or pinched.

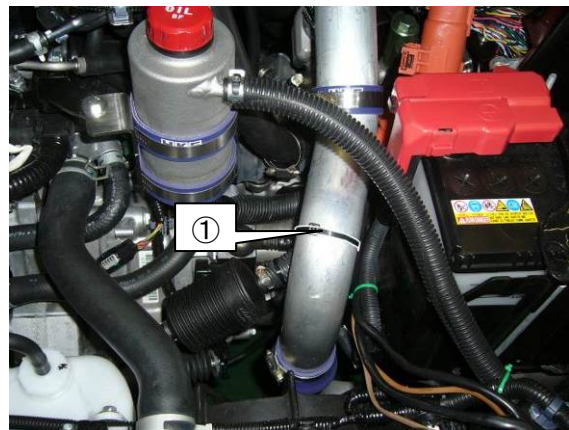

(21) Cut the Oil Resistant Hose 10mm to 80mm and 620mm in length. Cut the Hose 4mm to 450mm in length.

(22) Assemble the following parts to make the bypass valve activation hose connections as shown in the diagram on the right.

- ① 3-way Fitting
- ② Hose Clamps #4
- ③ Hose 4mm (L=450mm)
- ④ Oil Resistant Hose 10mm (L=80mm)
- ⑤ Hose Fitting 4mm
- ⑥ Hose Fittings 10mm
- ⑦ Tie Wrap

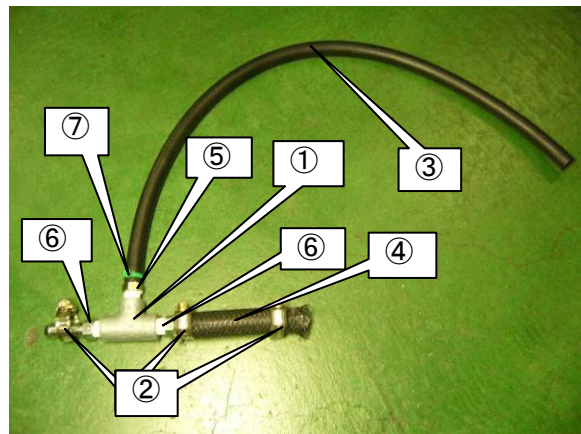

NOTE

- Install the hose fittings using sealing tape.

(23) Remove the factory vacuum hose, and install the 3 way fitting Assy between the intake manifold and factory vacuum hose.

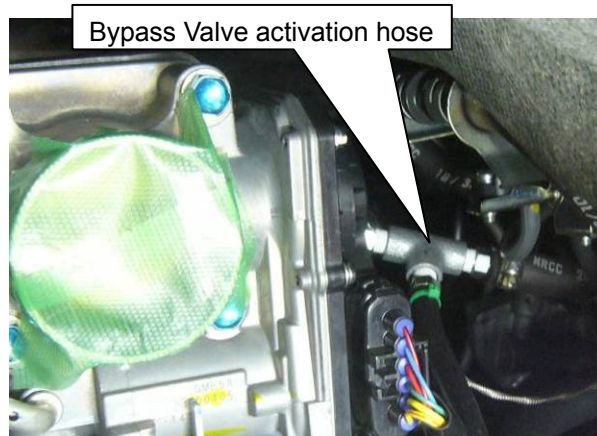
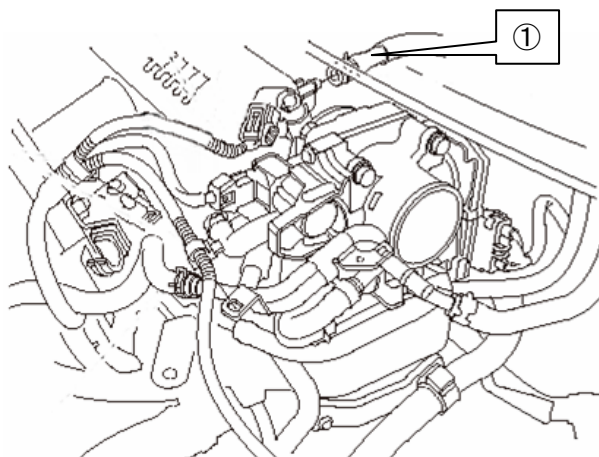

(24) Connect a 4mm rubber hose from the 3 way fitting to the Bypass Valve Assy using ① Tie Wrap.

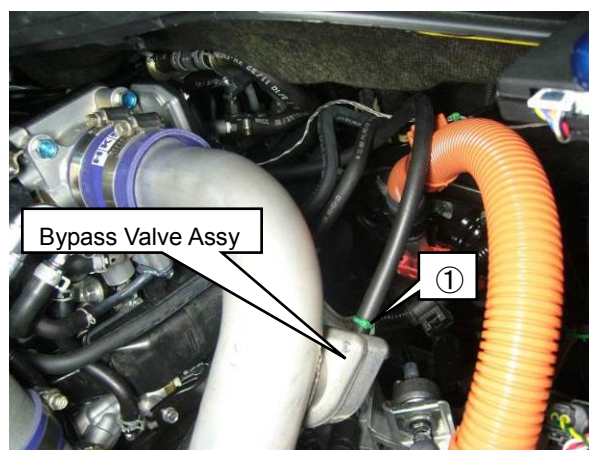

- **Modification of Factory Front Bumper Air Guide**

(25) Separate the removed factory front bumper air guide to the resin part and the rubber part.

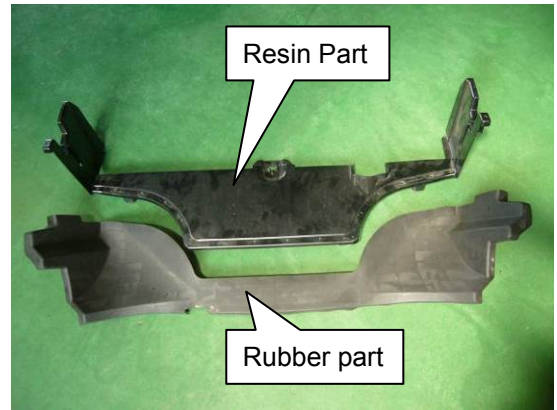

(26) Cut off ① on both sides of the resin part and ②, and the shaded portion ③.

NOTE

- The actual sizes to cut off may be slightly different. Measure the sizes using the actual parts before cutting.

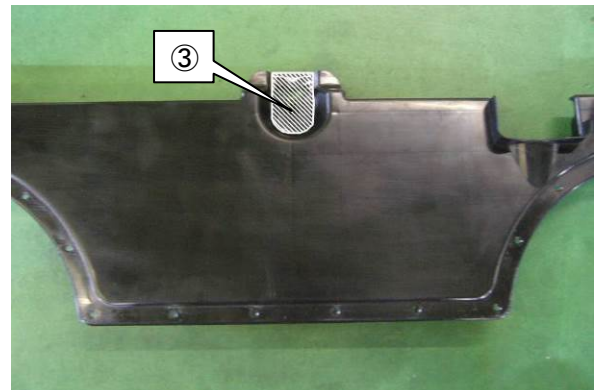
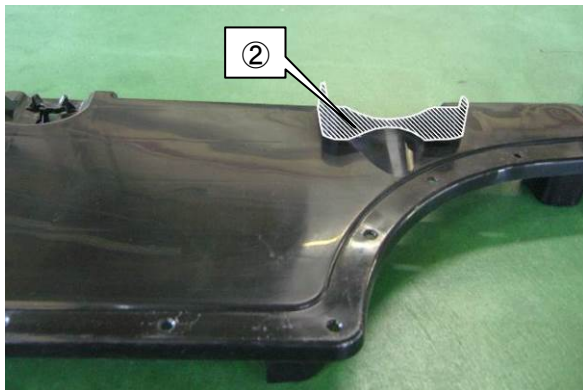
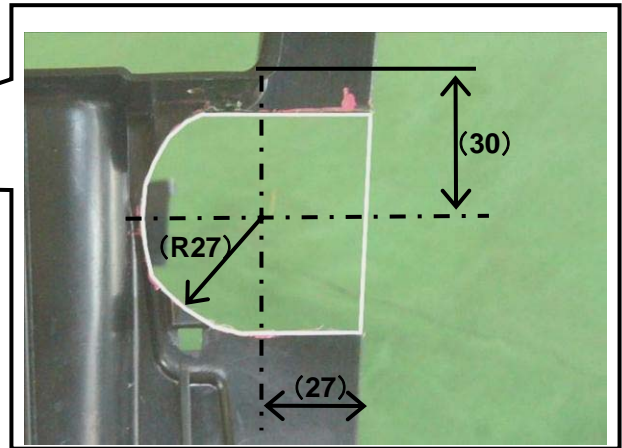
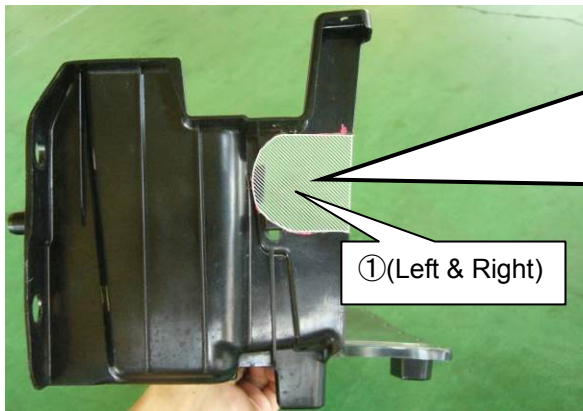

(27) Install the modified resin part of the factory front bumper air guide to the vehicle using the factory bolts and clips.

(28) Cut off the shaded portion ① on both sides of the rubber part of the factory front bumper air guide.

NOTE

- The actual sizes to cut off may be slightly different. Measure the sizes using the actual parts before cutting.

Do not cut off the rubber part to connect the resin part and the rubber part.

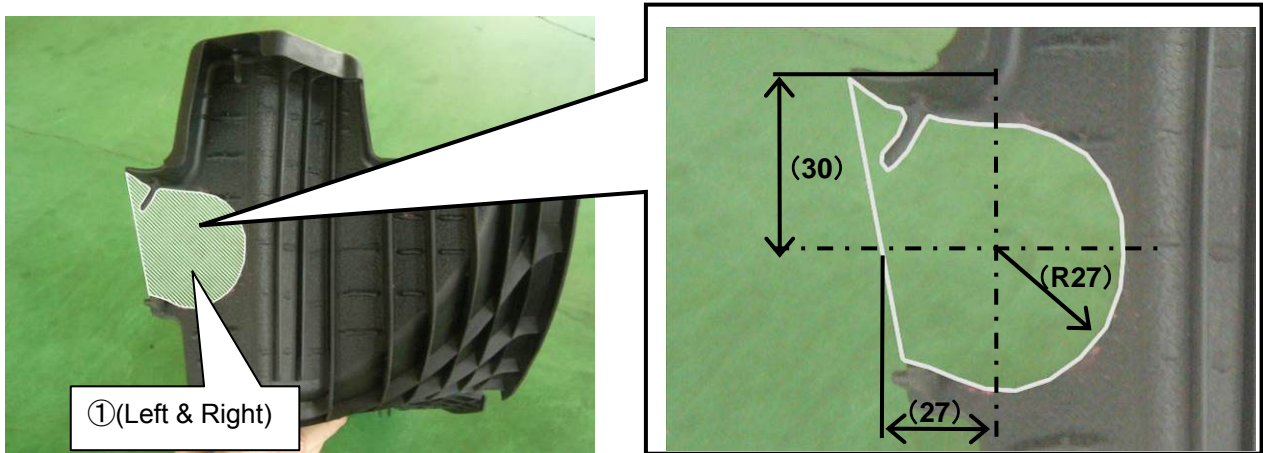

(29) Install the rubber part of the factory front bumper air guide to the vehicle.

• Installation of Suction Pipe

Parts List

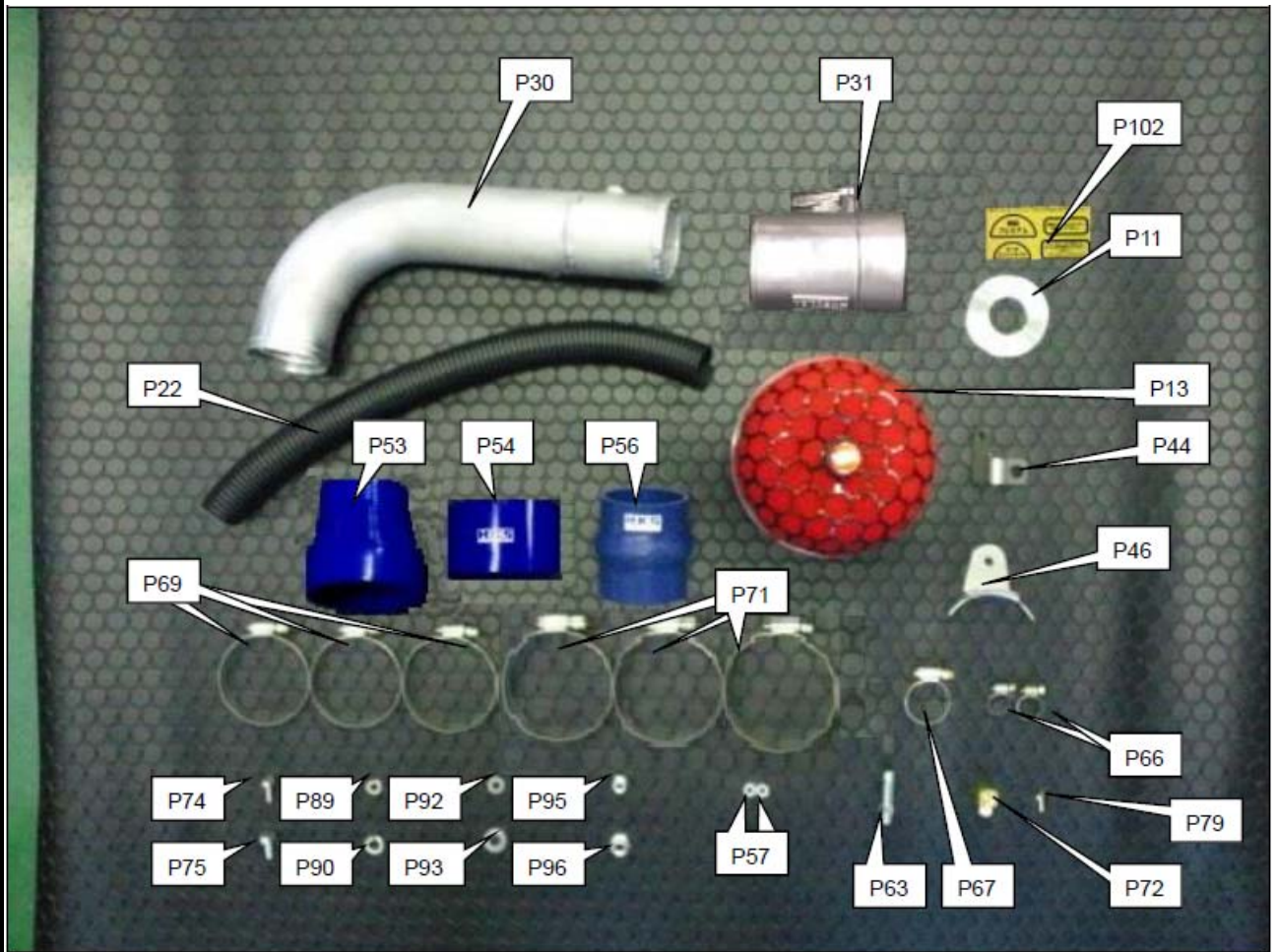

No.	Description	QT
P11	Restrictor $\phi 27$	1
P13	Air Filter 150mm-80mm Red	1
P22	Corrugated Tube 22mm	1
P30	Suction Pipe No.2	1
P31	Suction Pipe Adapter	1
P44	Suction Pipe Bracket	1
P46	Universal Pipe Bracket 80mm	1
P53	Silicone Hose 80mm L=55	1
P54	Different Dia. Silicone Hose 60-80mm	1
P56	Cushion Hose 60mm L=75	1
P57	Spacer M4 L=1.5	2
P63	Hose Fitting 10mm	1
P66	Hose Clamp #4	2
P67	Hose Clamp #16	1
P69	Hose Clamp #36	3
P71	Hose Clamp #48	3

P72	Elbow PT1/8	1
P74	Hexagon Bolt M6 L=15	1
P75	Hexagon Bolt M8 L=15	1
P79	Button Bolt M4 L=12	1
P89	Lock Washer M6	1
P90	Lock Washer M8	1
P92	Washer M6	1
P96	Washer M8	1
P95	Flange Nut M6	1
P96	Flange Nut M8	1
P102	High-Octane Decal	1

(30) Install ① Cushion Hose 60mm L=75 to ② Supercharger Assy using the Hose Clamp #36.

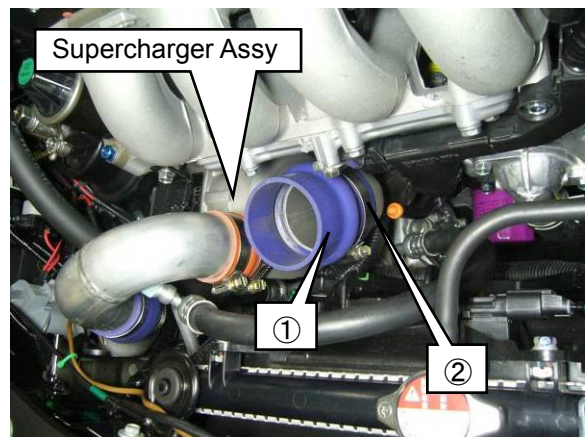

(31) Install ① Elbow and ② Hose Fitting 10mm to Suction Pipe No.2.

NOTE

- Install the hose fitting using sealing tape.

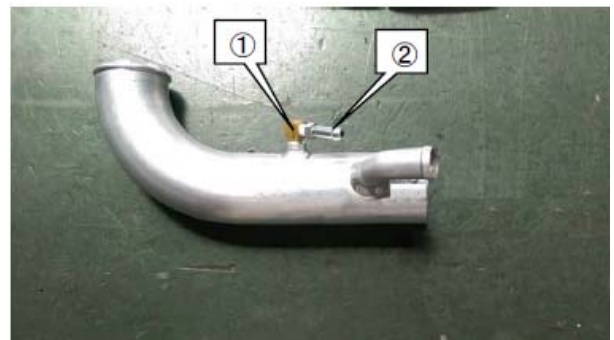

(32) Install ① Restrictor to Suction Pipe No.2.

Weld the portion shown in a dotted line (※) or fix firmly with heat resistant aluminum tape.

NOTE

- Install the stepped side of the restrictor to the Suction Pipe No.2.
- A proper restrictor must be selected by referring to the following chart.

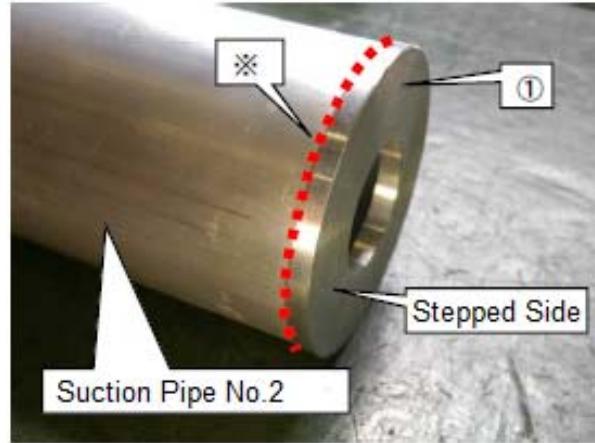
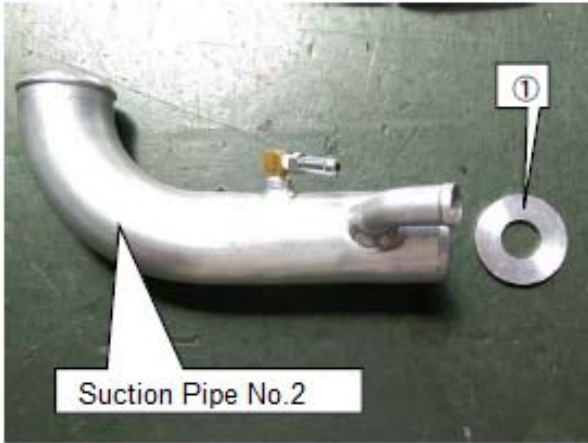

Specifications	Diameter of restrictor
Spec for JDM stock fuel parts (fuel pump, injector)	Φ27 (Included in this kit)
Spec for JDM HKS Fuel Upgrade Kit	Φ34 (Included in Fuel Upgrade Kit)

⚠ WARNING

- The restrictor adjusts the engine output. Select a restrictor suitable for the specification of the vehicle. Improper selection of the restrictor cannot adjust the engine output properly which may result in engine damage.
- Make sure to secure the restrictor firmly. Displacement and/or removal of the restrictor may cause the engine damage.

(33) Install ① Different Dia. Silicone Hose 60-80mm to the Suction Pipe No.2 using ② Hose Clamp #36.

NOTE

Make sure to secure the restrictor firmly.

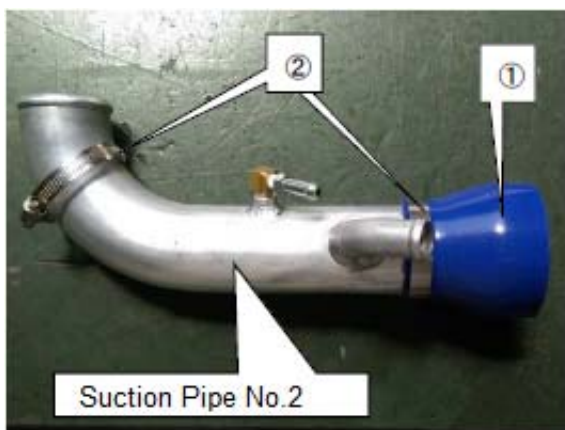

(34) Temporarily install the Suction Pipe No.2 Assy to the vehicle using the Hose Clamp #38 used in (33).

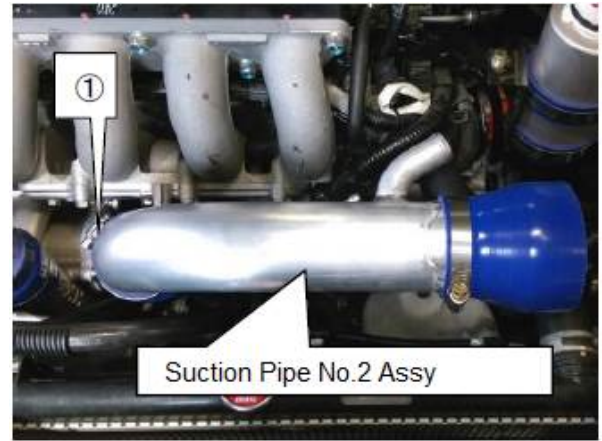

(35) Insert ①Spacer M4 L=1.5 between the airflow sensor removed from the factory air cleaner and Suction Adapter. Install the airflow sensor to the Suction Adapter using ②Button Bolt M4 L=12.

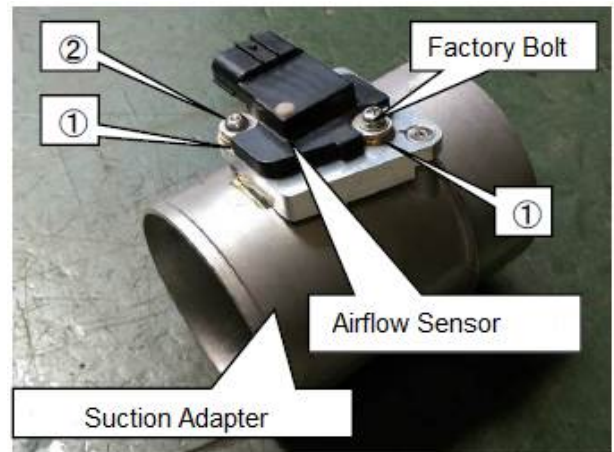

(36) Temporarily install the Air Filter to ④ Suction Adapter using the following parts.

- ①Silicone Hose 80mm L=55
- ②Hose Clamp #48
- ③Universal Pipe Bracket 80mm

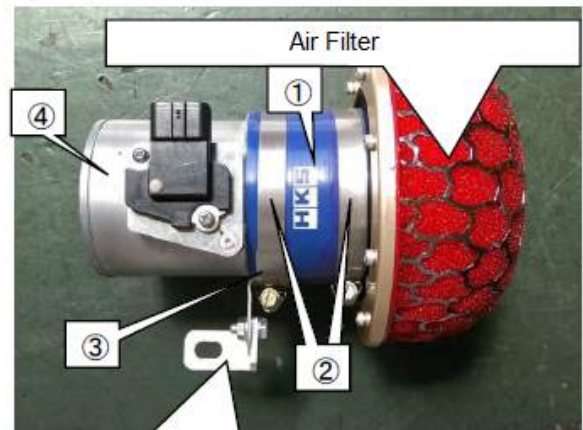

(37) Temporarily install the Suction Pipe Bracket to ④ Suction Adapter using the following parts.

- ① Hexagon Bolt M8 L=15
- ② Lock Washer M8
- ③ Washer M8
- ④ Flange Nut M8
- ⑤ Hose Clamp #36

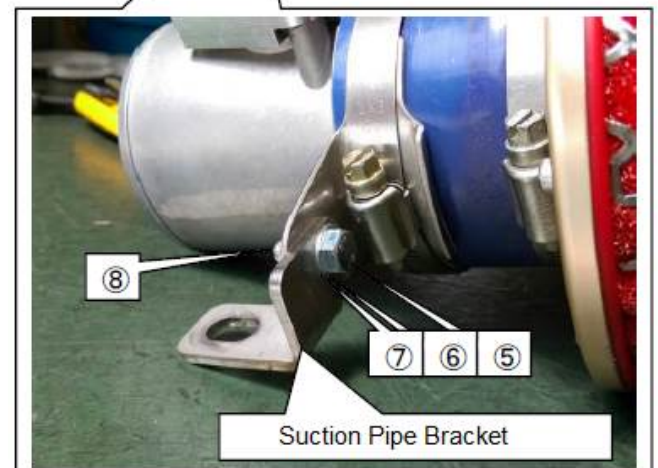

(38) Temporarily install the Suction Adapter Assy to the vehicle using the following parts.

- ① Hexagon Bolt M8 L=15
- ② Washer M8
- ③ Lock Washer M8
- ④ Flange Nut M8
- ⑤ Hose Clamp #38

Determine the installation positions of Suction Pipe No.2; then tighten all Bolts, Flange Nuts, and Hose Clamps temporarily installed.

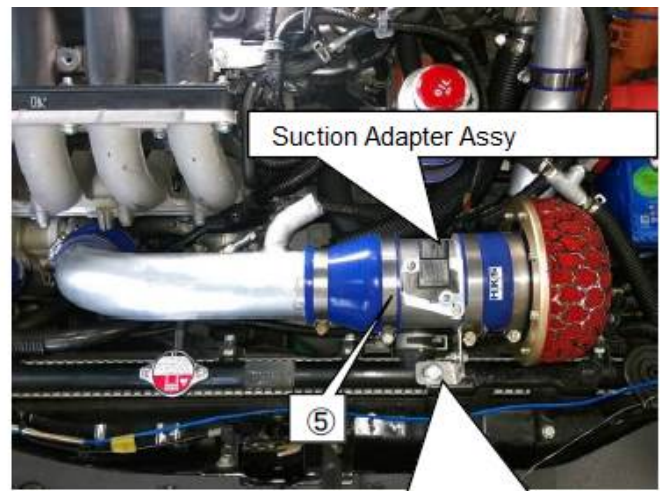

NOTE

- When installing the Suction Adapter Assy, make sure the airflow sensor's installation side is vertically to the ground.
- Make sure to adjust the position of the air filter so it does not come in contact with the factory bracket. (※)

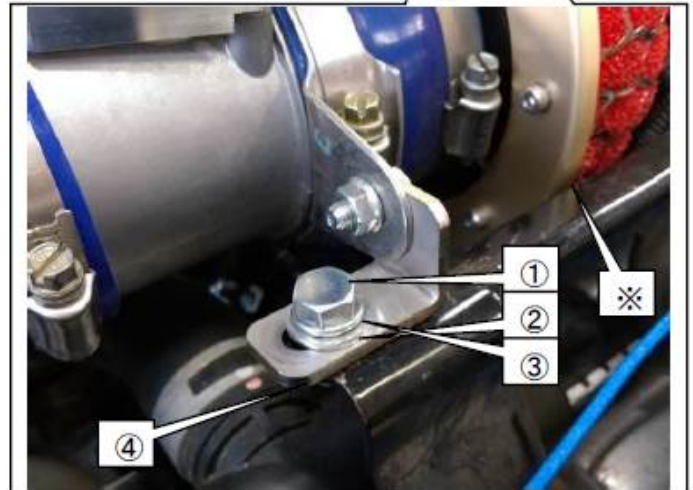

(39) Connect the Hose 22mm from the Bypass Valve to Suction Pipe No.2 using ① Hose Clamp #16.

(40) Cut the Corrugated Tube 22mm to 400mm in length.

(41) Install ②400mm Corrugated Tube 22mm to the 420mm Hose from the vehicle.

(42) Connect ③ Oil Resistant Hose 10mm L=620mm to the factory blow-by hose and Suction Pipe No.2 using ④Hose Clamp #4.

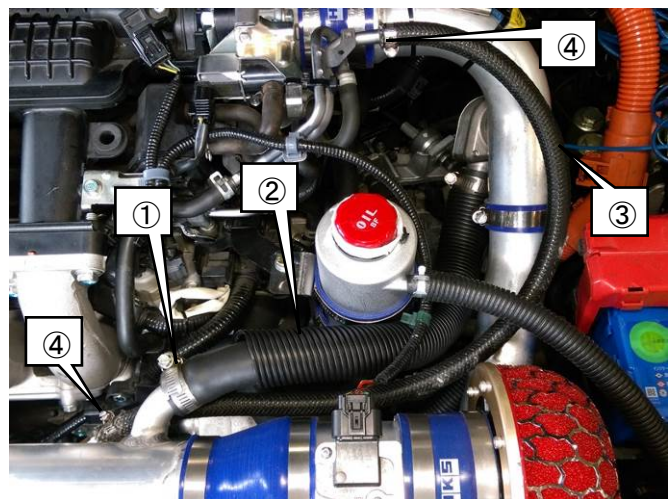

(43) Install the factory airflow sensor connector to the airflow sensor.

(44) Affix the High-Octane Decal on or near the gasoline filler cap.

5. Reinstallation of Factory Parts

Refer to the factory service manual to reinstall the factory parts.

- (1) Reinstall the front bumper center upper beam.
- (2) Reinstall the front bumper.
- (3) Reinstall the front bumper center seal.
- (4) Reinstall the front bumper side cover.
- (5) Reinstall the left and right side splash shields.
- (6) Reinstall the engine under cover.

6. Filling Traction Oil

Parts List		
		
No.	Description	QT
P4	Traction Oil	1

 **Caution** Do not allow foreign objects to mix with the Traction Oil. The internal components of the Supercharger Unit assembly are very precise and exact; foreign objects mixed with Traction Oil can lead to damage to the Supercharger Assy.

- (1) Check to make sure that there are no foreign objects in the Oil Tank. Add Traction Oil to the Traction Oil Tank (up to the dotted line in the diagram below). Close the cap properly and securely.

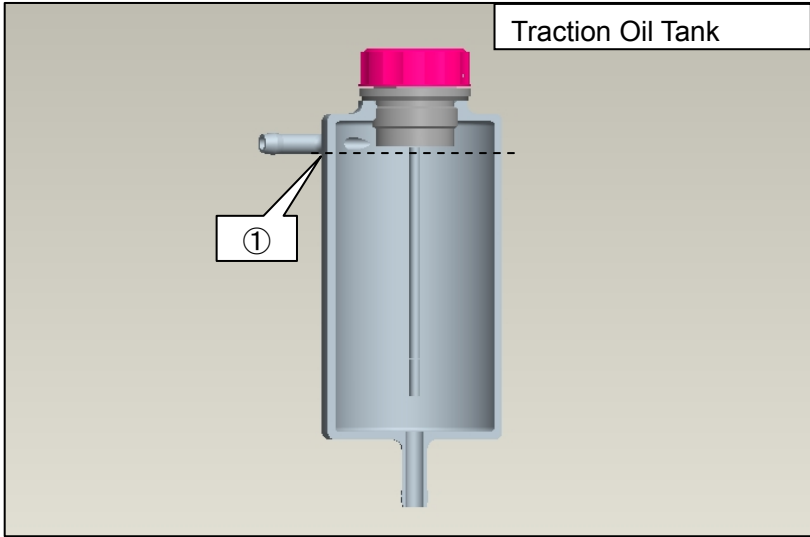

7. Engine ECU Data Rewriting

Parts List



No.	Description	QT
P105	Initialization Tool (USB Memory)	1



Caution

This product is Pro Kit. The engine management system is not included.
Make sure to prepare an engine management system for resetting.

To Use HKS Flash Editor for Engine ECU Control

If HKS Flash Editor (42015-AH002) is used to rewrite the engine ECU data, reflash the ECU referring to the manual of Flash Editor.

When using HKS Flash Editor, the initialization tool provided with this kit must be used.

Warning

- **The initialization tool included in Flash Editor is for 12001-AH007 (GTS4015HP). The setting data is different for 12001-AH008.**
- **Make sure to use the tool provided with this kit. Failure to do so may cause the engine damage.**

8. CONFIRMATION AFTER INSTALLATION / CHECKING TRACTION FLUID VOLUME

Check the following after the installation process is complete.

(1) Check off the following before starting the engine:

	Items to confirm:	Check
1	Make sure the hose layout is correct.	
2	Make sure the traction fluid is not leaking.	
3	Make sure the installed parts do not come in contact with any other parts.	
4	Make sure the belt is properly aligned with the grooves of the pulley.	
5	Make sure all bolts (especially the pulley bolts) are tightened properly.	
6	Make sure the Traction Oil is at the correct level.	
7	Make sure hoses are not kinked or bent.	
8	Make sure all hose clamps are tight.	
9	Make sure all bolts and nuts are tightened.	
10	Make sure all installed components are secured.	

(2) Prepare 80cc (2.7 oz) of Traction Oil in a beaker or small container and start the engine.

(3) Immediately after starting the engine, perform the following:

- i) Check to make sure that the oil level starts to decline, and then increase again.
- ii) Add oil from the 80cc beaker or small container, so that the Oil Tank level does not get empty. Also make sure that the Oil Tank does not overflow.

NOTE

• There may be some unusual or unpleasant noises emanating from the Supercharger unit after starting the engine. This is normal, and this noise will go away after the Traction Oil warms up (approximately 2-3 minutes).

(4) Start the engine and perform the following checks after the engine reaches normal operating temperature:

NOTE

• Do not raise the engine RPM while the engine is warming up; let it idle.

	Items to confirm:	Check
1	Make sure the Traction Oil returns to the Oil Tank.	
2	Make sure there are no leaks in the fuel, Traction Oil, coolant, or piping.	
3	Make sure there is no excessive stress on any fuel lines or hoses.	
4	Make sure the installed parts do not come in contact with any other	

- (5) After verifying the above items, raise and keep the RPM stable at 2000RPM for 10 seconds. Immediately shut off the engine and check the Traction Oil level. The level needs to be at level ① indicated in the diagram below. If it is lower, add Traction Oil as necessary.

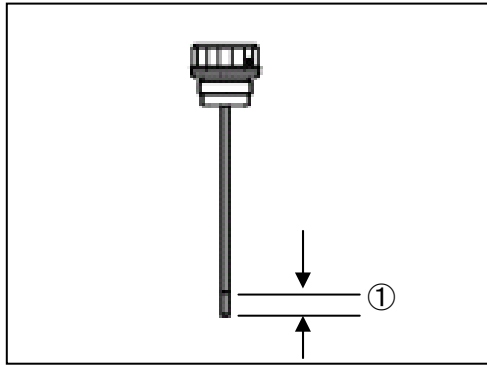

※ **If there is excess Traction Oil remaining in the bottle, replace the cap on the bottle and store in a safe location. Always store excess Traction Oil in the original bottle.**

- (6) Put the oil tank cap back on.

The installation process is now complete.



HKS Co., Ltd.
7181 Kitayama, Fujinomiya, Shizuoka 418-0192, Japan
<http://www.hks-power.co.jp/>