



## INSTALLATION MANUAL

Installation must be done by a professional.

Read this manual prior to the installation.

Always have access to this manual as well as a factory service manual.

※ Make sure the vehicle is applicable to this kit.

NAME OF PRODUCT	GT2 SUPERCHARGER SYSTEM
PART NUMBER	12001-KT004A With Flash Editor ※Only for Manual Transmission Vehicles 12001-KT004 Without Flash Editor
APPLICATION	12001-KT004A • SCION FR-S & SUBARU BRZ Manual Transmission Vehicles 2012~2014/early ※Applicable vehicle's year depends on the ECU ID compatible with Flash Editor. 12001-KT004 • SCION FR-S & SUBARU BRZ 2012~
ENGINE	FA20
REMARKS	<ul style="list-style-type: none"> <li>○ HKS will not be responsible for any and all damages to the vehicle's engine or other supplemental devices through the use of this product.</li> <li>○ Modifications of the radiator support, alternator bracket, oil, oil level gauge's boss attached to the front chain cover, etc. are required.</li> <li>○ The data preset to Flash Editor is for manual transmission vehicles. The data is not compatible with automatic transmission vehicles. (12001-KT004A)  Data of Flash Editor has been made based on the use of 91 octane pump gas.  To use with Flash Editor, the factory data of the exhaust systems are as follows Page 3.</li> <li>○ In order to confirm the corresponding ID of the Flash Editor, please visit <a href="http://www.hksusa.com/gt-supercharger-kit-v3-ecu-package-fr-s-brz/">http://www.hksusa.com/gt-supercharger-kit-v3-ecu-package-fr-s-brz/</a> (12001-KT004A)</li> <li>○ Fuel and ignition settings are required. If neglected, the engine may be damaged.(12001-KT004)</li> <li>○ Engine oil's viscosity must be higher than 40.</li> </ul>

### REVISION OF MANUAL

Rev. Number	Date	Manual Number	Details
3-3.01	2018/4	E04215-A40050-00	1 <sup>st</sup> Edition

## INDEX

NOTICE / ATTENTION / SAFETY PRECAUTIONS	1
PARTS LIST	2
REQUIRED PARTS LIST (12001-KT004A)	5
1. INSTALLATION OF Flash Editor(ONLY 12001-KT004A)	6
2. REMOVAL OF FACTORY PARTS	6
3. MODIFICATION & RELOCATION OF FACTORY PARTS	9
4. INSTALLATION OF GT2 SUPERCHARGER	19
5. INSTALLATION OF INTERCOOLER	23
6. INSTALLATION OF TRACTION FLUID TANK	24
7. INSTALLATION OF SUCTION PIPE	29
8. INSTALLATION OF INTERCOOLER PIPES	31
9. INSTALLATION OF BLOW-OFF VALVE	34
10. REINSTALLATION OF FACTORY PARTS	38
11. CONFIRMATION AFTER INSTALLATION & FILLING TRACTION FLUID	39
12.1 <sup>ST</sup> MONTH INSPECTION	41
13. MAINTENANCE	42
14. TROUBLESHOOTING	42
15. IF BELT BREAKS	42

## NOTICE

This manual assumes that you have and know how to use the tools and equipment necessary to safely perform service operations on your vehicle. This manual assumes that you are familiar with typical automotive systems and basic service and repair procedures. Do not attempt to carry out the operations shown in this manual unless these assumptions are correct. Always have access to a factory service manual. To avoid injury, follow the safety precautions contained in the factory service manual.

## ATTENTION

- This manual indicates items you need to pay attention to in order to install this product safely and lists precautions to avoid any possible damage and/or accidents.
- This product is an automobile part. Do not use for any other purposes.
- HKS will not be responsible for any damage caused by incorrect installation and/or use, or use after modification and/or dismantling of this product.
- This product was designed for installation on a specific factory vehicle.
- The specifications of this product are subject to change without notice.
- The instructions are subject to change without notice. Make sure to refer to the most recent instructions.

## SAFETY PRECAUTIONS

The following precautions for use of this product are to prevent possible accidents and/or injuries and for proper use.



**WARNING:** Indicates risk of serious injury and/or possible death.



**CAUTION:** Indicates risk of serious injury and/or possible property damage (i.e. vehicle damage as from use of this product.).

# PARTS LIST

No.1

NO.	DESCRIPTIONS	QT	REMARKS
1	GT2 Supercharger	1	GT2-7040L
2	Supercharger Pulley	1	φ110mm-6PK
3	Supercharger Bracket No.1	1	Steel Plate
4	Supercharger Bracket No.2	1	Cast
5	Supercharger Bracket Spacer No.1	2	φ16-6 L36.2
6	Supercharger Bracket Spacer No.2	1	φ 20-8 L52.3
7	Supercharger Bracket Spacer No.3	1	φ16-8 L82.8
8	Supercharger Bracket Spacer No.4	1	φ23-10 L10.6
9	V-Ribbed Belt	1	6PK2160
10	Intercooler	1	
11	Suction Pipe	1	
12	Suction Pipe Gasket	1	
13	Intercooler Inlet Pipe	1	
14	Intercooler Outlet Pipe No.1	1	
15	Intercooler Outlet Pipe No.2	1	
16	Blow-off Valve	1	
17	Blow-off Valve Gasket	1	
18	Traction Fluid	1	
19	Traction Fluid Tank	1	
20	Traction Fluid Filter	1	
21	Traction Fluid Cooler	1	
22	Intercooler Bracket No.1	1	
23	Intercooler Bracket No.2	1	
24	Intercooler Inlet Pipe Bracket	1	
25	Traction Fluid Filter Bracket	1	
26	Traction Fluid Cooler Bracket No.1	1	
27	Traction Fluid Cooler Bracket No.2	1	
28	Silicone Hose 75mm L60	1	
29	Silicone Hose 75mm L55	1	
30	Silicone Hose 60mm L70	3	
31	Silicone Hose 55mm L43	1	
32	Silicone Hose 50-60mm	1	
33	Silicone Hose 22mm	1	
34	Silicone Hose 12-18mm	1	
35	Traction Fluid Hose 9mm	1	L600
36	Traction Fluid Hose 8mm	1	L2000
37	Hose 10mm	1	L200
38	Hose 4mm	1	L1000

# PARTS LIST

No.2

NO.	DESCRIPTIONS	QT	REMARKS
39	Corrugated Tube 15mm	1	L2000
40	Corrugated Tube 10mm	1	L70
41	Oil Level Gauge Clamp	1	
42	Joint Pipe 12mm	1	
43	T-fitting 10mm-4mm-10mm	1	
44	Spacer T=5	1	
45	Insulator Rubber	1	
46	Rubber Cap 50mm	1	
47	Rubber Cap 16mm	1	
48	Hose Clamp #48	4	
49	Hose Clamp #40	7	
50	Hose Clamp #36	3	
51	Hose Clamp 26.0mm	2	Mark 260
52	Hose Clamp 23.0mm	1	Mark 230
53	Hose Clamp 18.0mm	2	Mark 180
54	Hose Clamp 15.5mm	6	Mark 155
55	Hose Clamp 13.8mm	3	Mark 138
56	Hose Clamp 13.0mm	6	Mark 130
57	Hose Clamp 11.5mm	3	Mark 115
58	Hose Clamp 6.8mm	2	Mark 68
59	Cap Bolt M10 L50	1	
60	Cap Bolt M10 L45	1	
61	Cap Bolt M8 L125	1	
62	Cap Bolt M8 L115	1	
63	Cap Bolt M8 L90	1	
64	Cap Bolt M8 L20	6	
65	Cap Bolt M6 L55	2	
66	Cap Bolt M6 L18	2	
67	Dish Bolt M8 L35	3	
68	Hexagon Bolt M8 L25	1	
69	Hexagon Bolt M8 L20	5	
70	Hexagon Bolt M6 L20	2	
71	Flange Bolt M6 L18	3	
72	Low Head Cap Bolt M6 L12	5	
73	Flat Washer M8	10	
74	Flat Washer M6 Major Dia.	4	
75	Flange Nut M8	4	
76	Flange Nut M6	2	

# PARTS LIST

No.3

NO.	DESCRIPTIONS	QT	REMARKS
77	Tie Wrap (M)	9	
78	Flash Editor	1	Included only with 12001-KT004A
79	Installation Manual	1	
80	Operation Manual	1	

# REQUIRED PARTS LIST 12001-KT004A

## (In order to use the data of Flash Editor)

· Vehicles using the custom data can use the item with "●" or "○" on the installed parts list below:

●: Required parts to use the custom data

○: Usable parts to use the custom data

×: Prohibited parts to use the custom data

	Parts installed		HKS S/C	
	Product Name	Code No.	RON91	E85
Intake Parts	GT2 S/C SYSTEM ZN6/ZC6 FA20 USA	12001-KT004A	●	●
	GT2 S/C SYSTEM Pro FR-S	12001-KT004	(Any one)	(Any one)
	Pulley Up Grade Kit	12002-KK001	×	●
	AIR INTAKE DUCT ZN6/ZC6 FA20	70999-AT001	○	○
	Premium Suction ZN6/ZC6 FA20	70018-AT006	×	×
	SUPER HYBRID FILTER TOYOTA type20	70017-AT020	×	×
	RACING SUCTION R ZN6/ZC6 86/BRZ FA20	70020-AT022	×	×
	GT SUCTION KIT ZN6/ZC6 FA20	70025-AT001	×	×
Exhaust Parts Muffler	LEGAMAX Sports S-Tail ZN6/ZC6	32018-AT041	● (Any one)	● (Any one)
	Hi-Power Muffler SPEC-L ZN6	32016-AT023		
	Hi-Power Single Racing Version FR-S	32016-BT002		
Exhaust Parts Manifold	SUPER MANIFOLD W/ CATA R-SPEC ZN6/ZC6	33005-AT006	● (Any one)	● (Any one)
	SUS EXHAUST MANIFOLD Scion FR-S & SUS FRONT PIPE Scion FR-S	33002-BT001		
		33004-BT002		
Spark Plug	SUPER FIRE RACING M50HL	50003-M50HL	●	●
Fuel Parts	Deatsch Werks Fuel Injector 700cc ※Not HKS Product	16U-02-0700-4 ※Not HKS Product	×	●
	Deatsch Werks Fuel Pump ※Not HKS Product	9-651-1010 ※Not HKS Product	×	●

# 1. INSTALLATION OF Flash Editor(ONLY 12001-KT004A)

PARTS LIST				
	NO	DESCRIPTIONS	QT	
	P78	Flash Editor	1	

(1) Install the data referring to the installation manual attached to Flash Editor.

- P78 Flash Editor X1

**⚠ CAUTION**

If the installation of Flash Editor is not successful, Flash Editor might not correspond to the ECU ID of the vehicle.  
 In that case, you need to use the other setting tool.  
 When mounting the Supercharger without ECU setting, there is a risk of damage to the engine.

# 2. REMOVAL OF FACTORY PARTS

Refer to this instruction manual and the factory service manual to remove the factory parts.

Parts List			
	NO.	DESCRIPTIONS	QT
Refer to the parts list on page 3.	P47	Rubber Cap 16mm	1

- (1) Disconnect the cable from the battery.
- (2) Remove the engine under cover. (Keep it for later use.)
- (3) Remove ①side signal lights from both sides. (Keep them for later user.)
- (4) Remove ②front bumper. (Keep it for later use.)

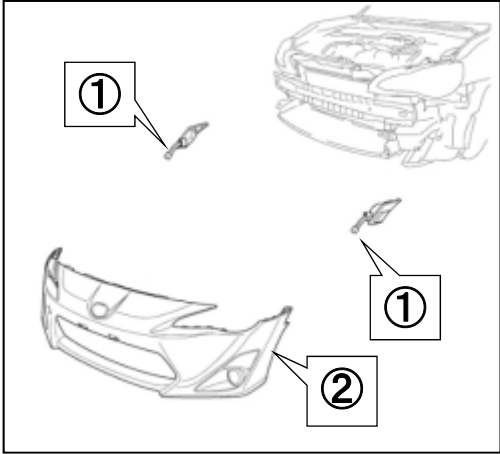

- (5) Remove ③ front bumper energy absorber. (Keep it for later use.)
- (6) Remove ④ front bumper reinforcement from both sides.
- (7) Remove ⑤ radiator cover plate.
- (8) Remove ⑥ horn. (Keep it for later use.)
- (9) Remove ⑦ front bumper cover LWR. (Keep it for later use.)
- (10) Remove ⑧ front bumper bracket. (Keep it for later use.)
- (11) Remove ⑨ air cleaner case. (Keep it for later use.)

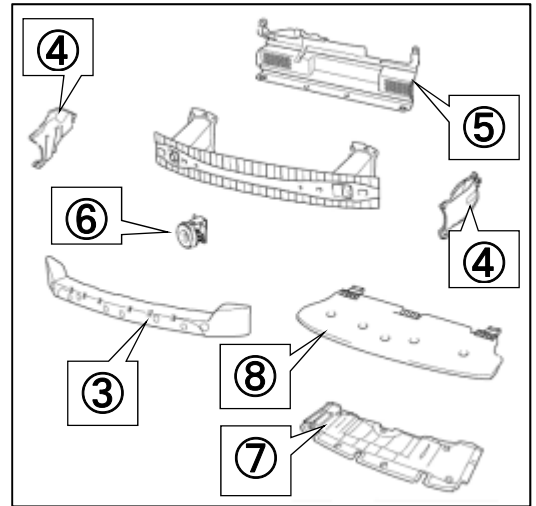

- (12) Remove ⑩ belt cover.
- (13) Remove ⑪ belt cover. (Keep it for later use.)

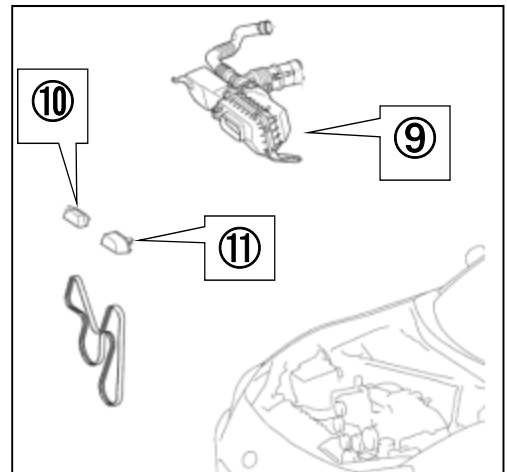

- (14) Remove ⑫ air cleaner duct. (Keep it for later use.)
- (15) Remove ⑬ hood lock from the radiator support. (Keep it for later use.)
- (16) Remove ⑭ radiator support. (Keep it for later use.)

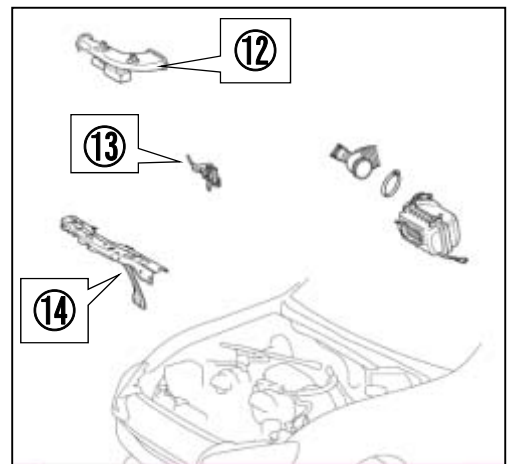

- (17) Hold the tensioner pulley with a tool and rotate the tensioner to the right to lower the tension. Remove ⑮ belt.

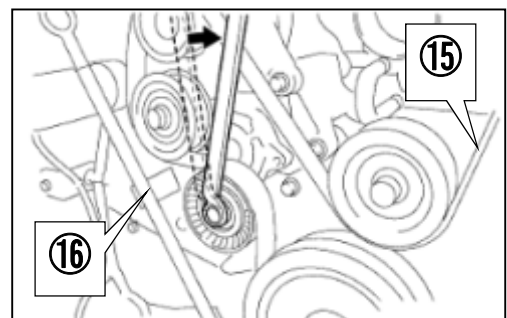

- (18) Remove ⑯ oil level gauge. (Keep it for later use.)



(19) Remove ①⑦ air cleaner duct, ①⑧ chamber, and ①⑨ hose.

(20) Install Rubber Cap 16mm to the position ①⑨ hose was removed.

- P47 Rubber Cap 16mm x 1

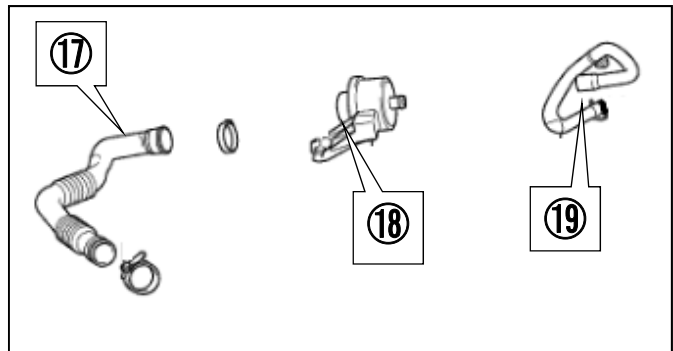

(21) Remove ②⑩ alternator. (Keep it for later use.)

(22) Remove ②⑪ idler pulley.

(23) Remove ②⑫ auto-tensioner. (Keep it for later use.)

(24) Remove ②⑬ alternator bracket. (Keep it for later use.)

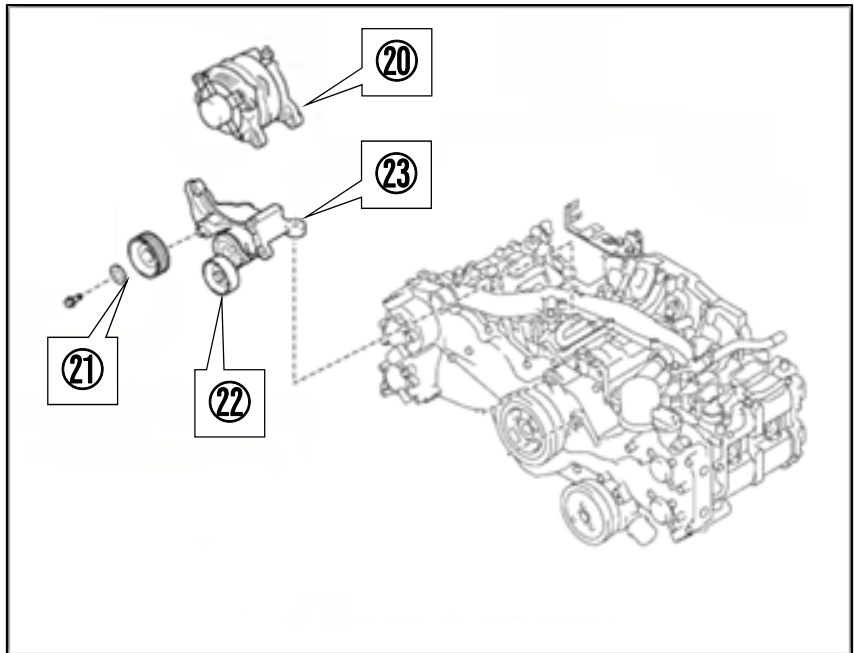

(25) Remove ②⑭ horn. (Keep it for later use.)

(26) Remove ②⑮ outside temperature sensor. (Keep it for later use.)



### 3. MODIFICATION & RELOCATION OF FACTORY PARTS

PARTS LIST			
	NO.	DESCRIPTIONS	QT
	P22	Intercooler Bracket No.1	1
	P40	Corrugated Tube 10mm	1
	P46	Rubber Cap 50mm	1
	P53	Hose Clamp 18.0mm	1
	P55	Hose Clamp 13.8mm	1
	P56	Hose Clamp 13.0mm	1
	P57	Hose Clamp 11.5mm	3
	P66	Cap Bolt M6 L=18	2
	P74	Flat Washer M6 Major Dia.	2
	P77	Tie Wrap (M)	2

(1) Remove the A/C condenser bracket on the upper right side. Cut off the shaded area of the bracket shown in the diagram on the right.



(2) Reinstall the A/C condenser bracket modified in 3. (1) to the original position.

(3) Drill an 8mm hole in the front bumper reinforcement in the position indicated in the diagram below.

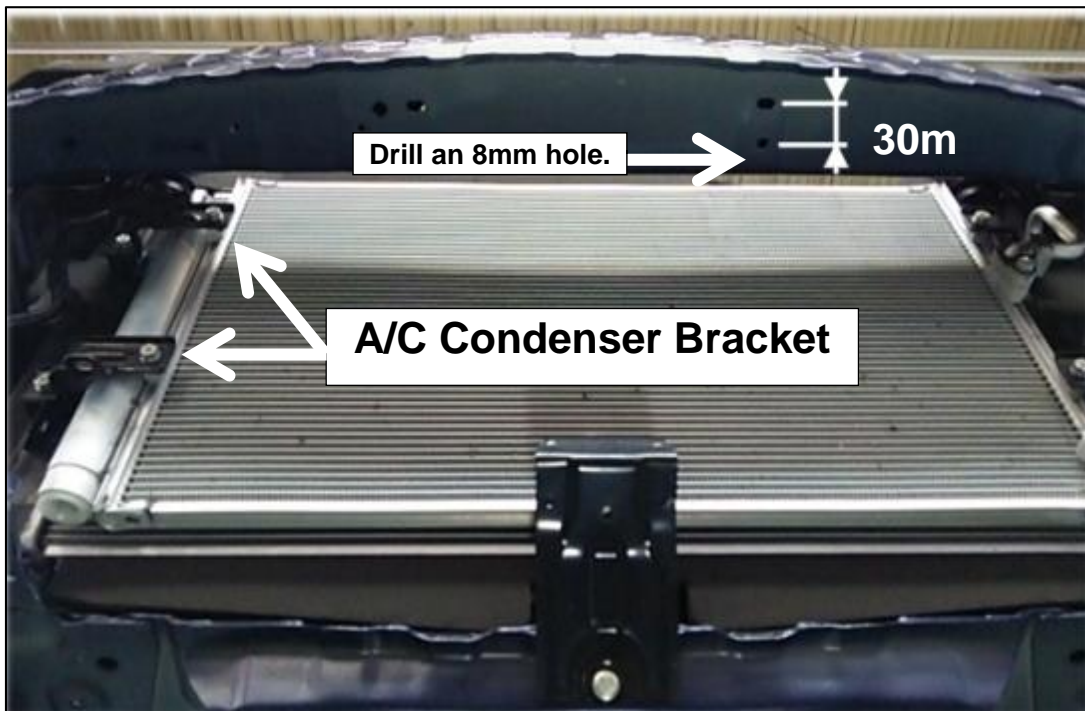

(4) Temporarily install Intercooler Bracket No.1 to the hose made in 3.(3).

- P22 Intercooler Bracket No.1 x 1
- P66 Cap Bolt M6 L=18 x 2
- P74 Flat Washer M6 Major Dia. x 2

**NOTE**

- For easier installation, use a magnet hand or something similar.
- For easier installation, insert a ball point hexagon wrench from the upper side of the front bumper reinforcement.

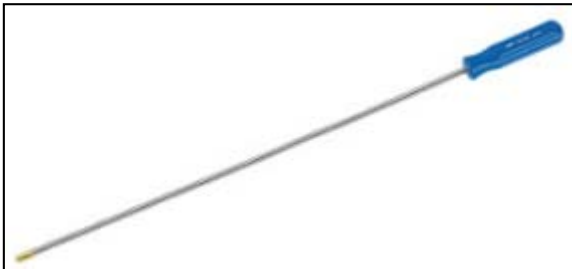

(5) Put the cut with scissors in the position shown in the illustration of the sponge .



(6) Shave 2mm of the pipe clamp on the A/C condenser of the passenger's side as shown below.

**NOTE**

- ◇ This must be done so the condenser does not come in contact with the traction fluid cooler.

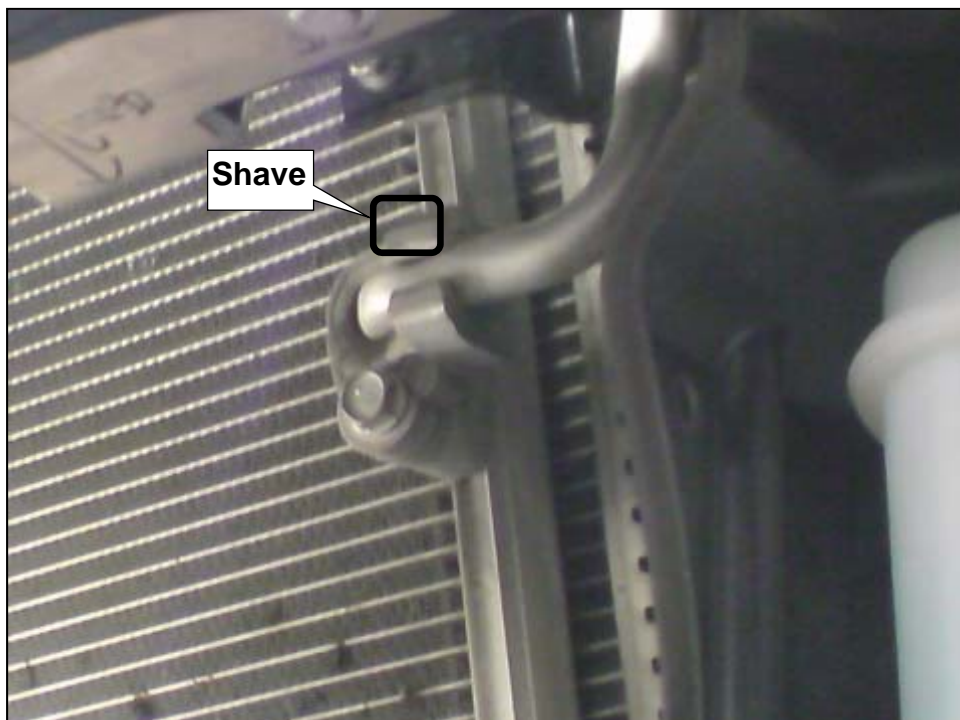



(7) Remove the bracket from ⑥horn removed in 2.(8).



(8) Rotate the horn bracket to the position shown in the diagrams below.



(9) Remove the plastic guide and clip from the horn and outside temperature sensor.

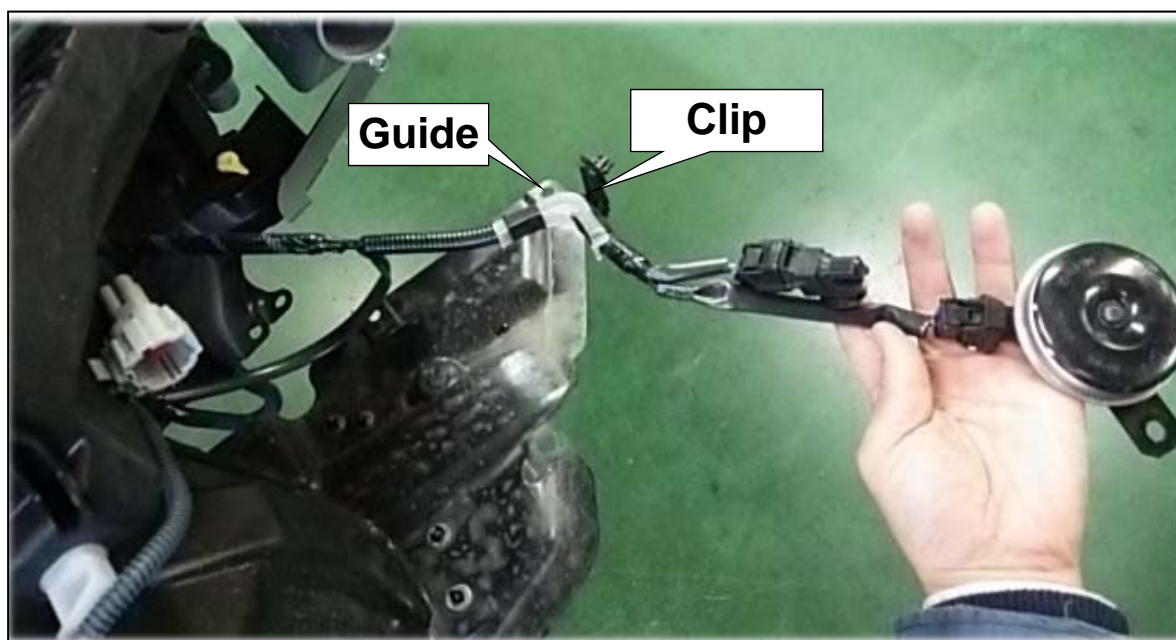

- (10) Install the outside temperature sensor and horn to the A/C condenser bracket install in 3.(2).

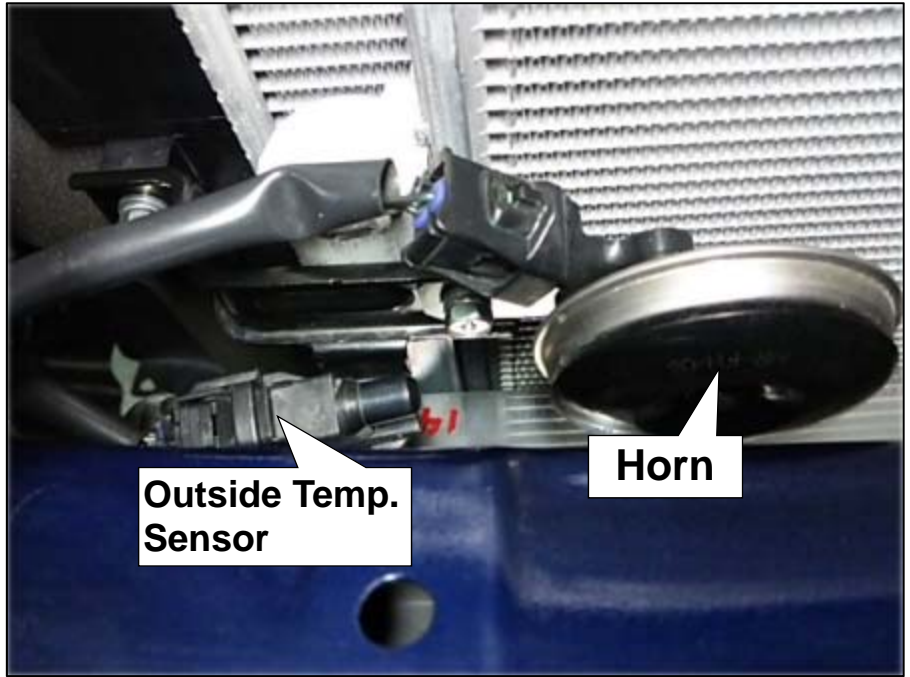

- (11) Cut off the portion of the A/C condenser bracket on the lower right side along the dotted line shown in the diagram on the right.

**NOTE**

- ✧ This modification must be done so the bracket does not come in contact with the intercooler.

- (12) Reinstall the A/C condenser bracket to the original position.

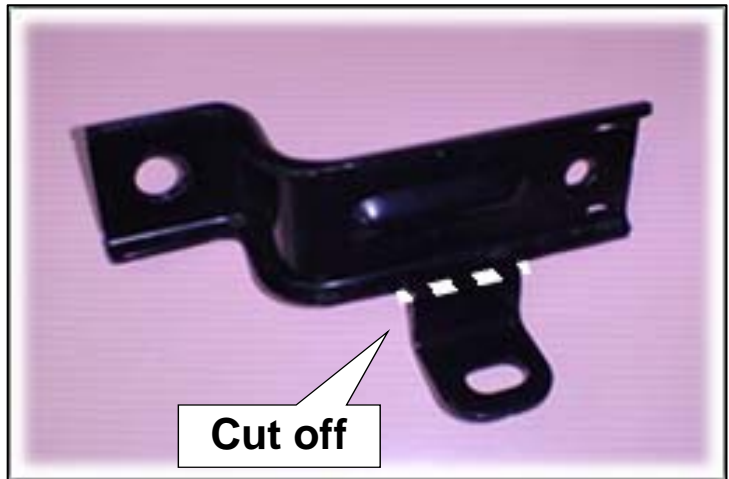

- (13) Cut off the shaded area of the ⑭ radiator support removed in 2.(16) shown in the diagram on the right.

- (14) Drill 4 of 5mm hole in ⑭ radiator support in the positions shown in the diagram on the right.

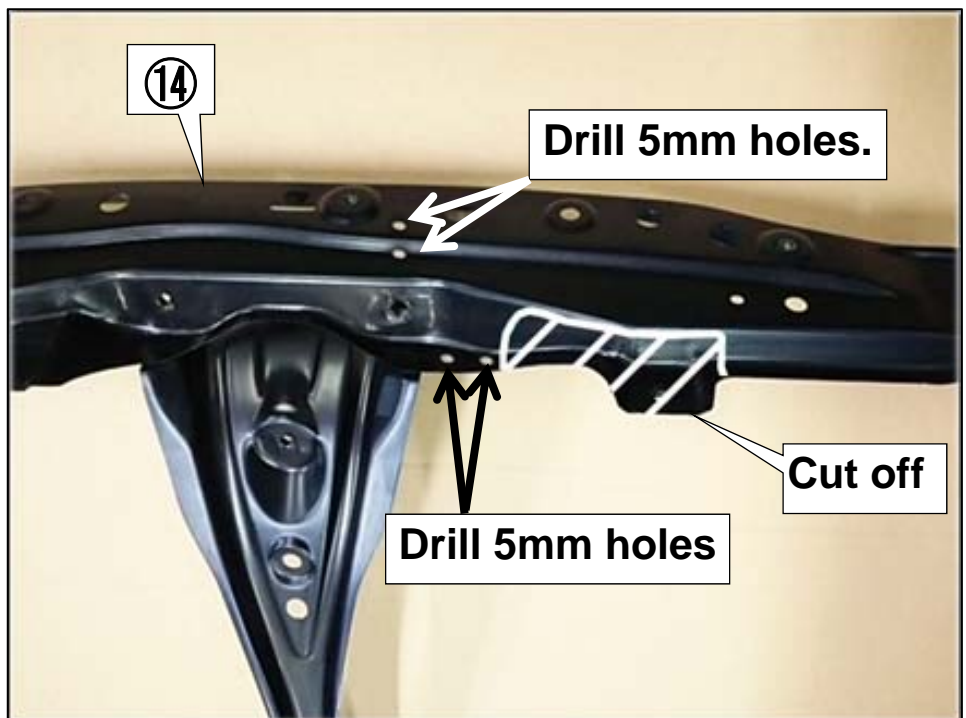

(15) Cut off the shaded portions of the electric fan shown in the diagram on the right.

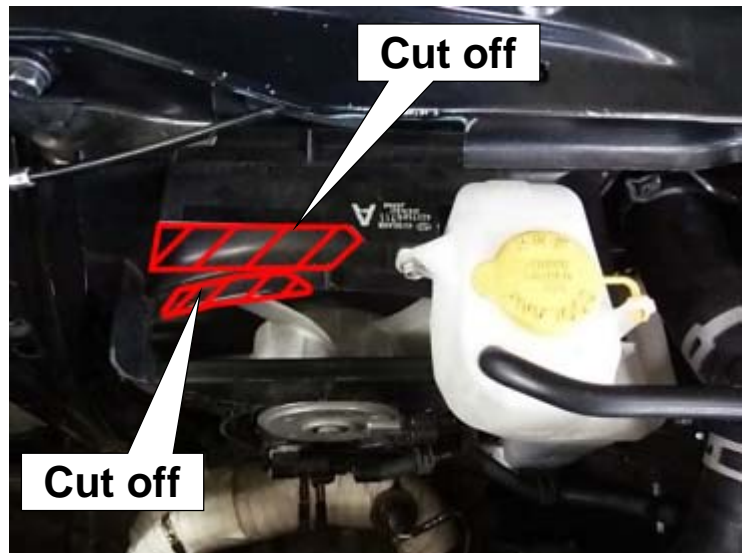

(16) Shave the boss installing the front chain cover's oil level gauge by 4mm so the height becomes 5mm.

**NOTE**

- ✧ This process is to prevent the supercharger pulley from coming into contact with the boss.
- ✧ Use a belt sander or grinder to allow ease of work.
- ✧ Cover other parts with a cloth to prevent any debris and/or foreign objects from entering into inside the throttle or any other parts of the vehicle.

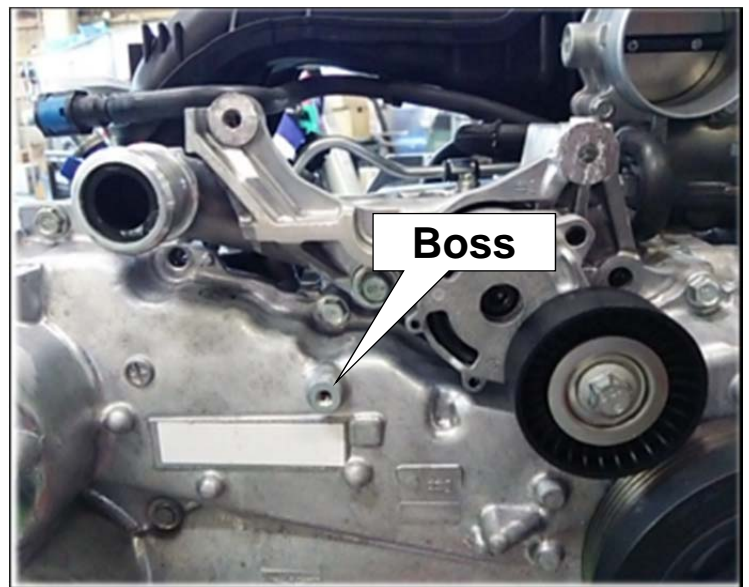

**Front Chain Cover**

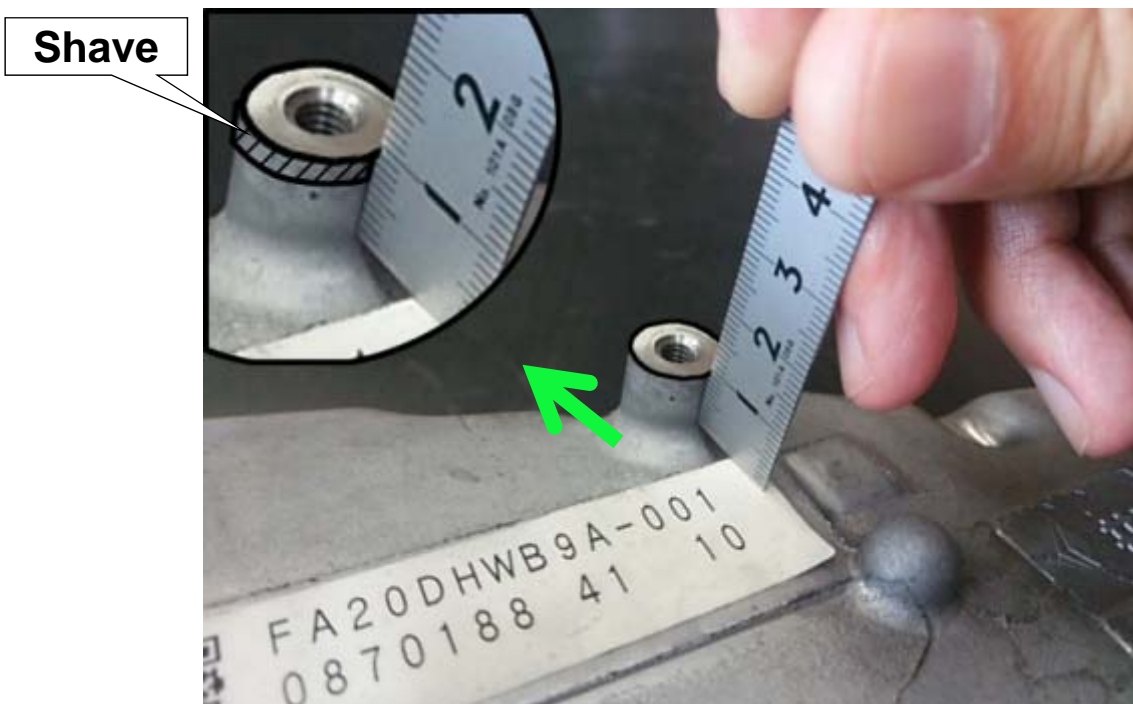



(17) Cut off the portion of the idler pulley installing part of ②③ alternator bracket removed in 2.(24) along the dotted line shown in the diagram on the right.

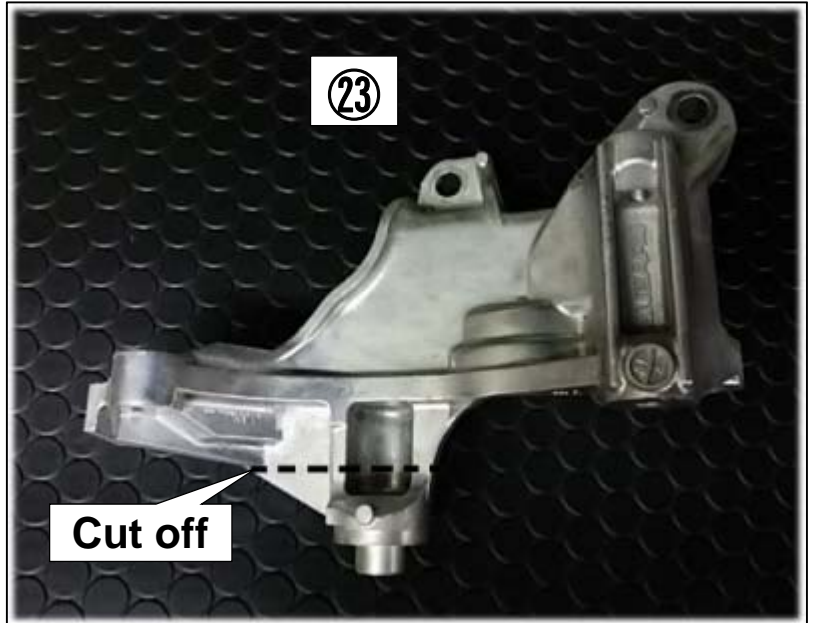

(18) Install ②③ alternator bracket modified in 3.(17) to the engine.

(19) Remove one M10 bolt from ②③ alternator bracket installed in 3.(18) referring to the diagram on the right.

**NOTE**

✧ Supercharger Bracket will be installed in this position later.

(20) Remove one M8 bolt securing the timing chain cover referring to the diagram on the right.

**NOTE**

✧ Supercharger Bracket will be installed in this position later.

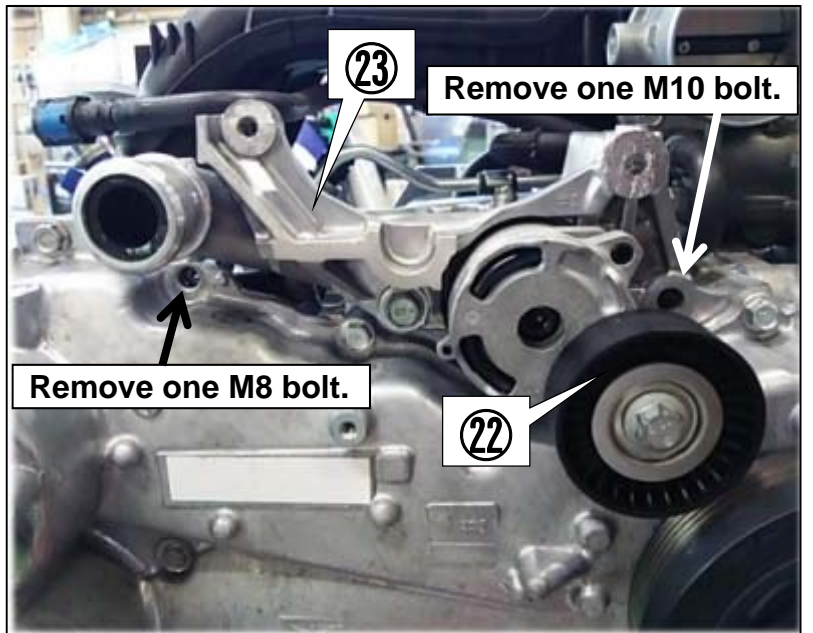

(21) Install ②② auto tensioner removed in 2.(23) to ②③ alternator bracket.

(22) Temporarily install ②① alternator removed in 2.(21) to ②③ alternator bracket.

(23) Remove the resonator from ⑨ air cleaner case removed in 2.(11).

**NOTE**

✧ Remove 2 rivets using a drill.

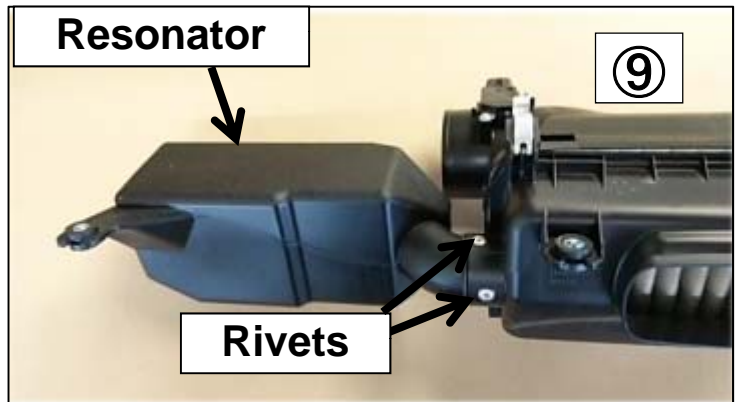

(24) Cut off the portion of ⑨air cleaner case modified in 3.(23) along the dotted line shown in the diagram on the right.

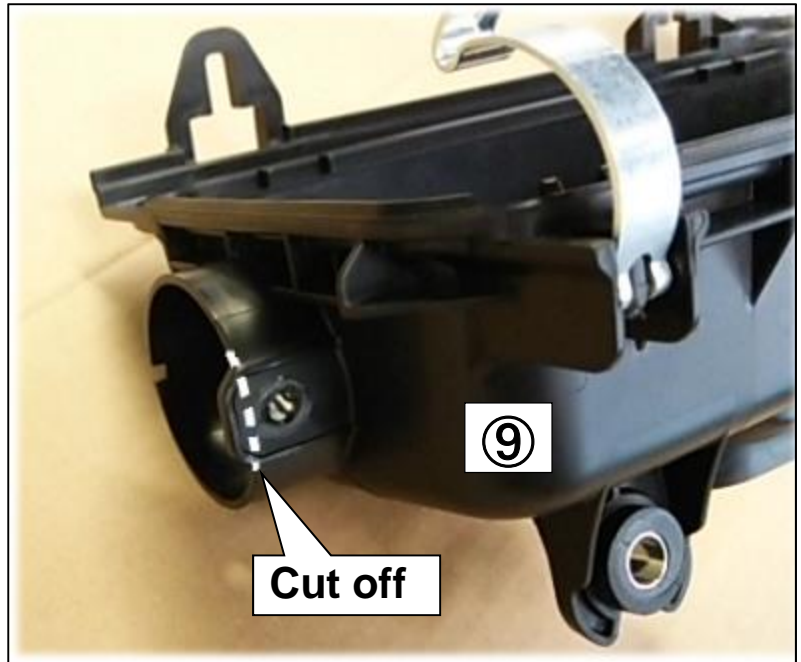

(25) Cut the Rubber Cap 50mm as shown in the diagram below.

- P46 Rubber Cap 50mm x 1

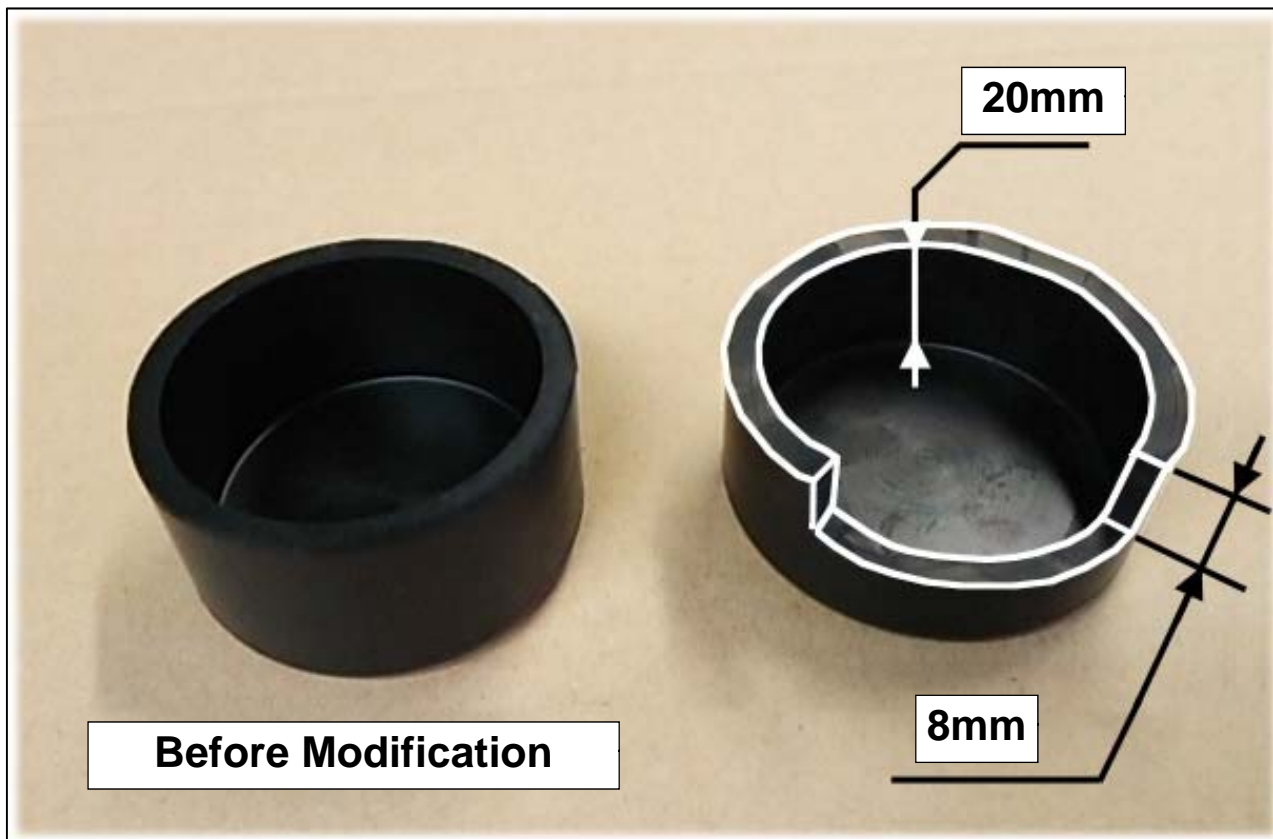

(26) Install the Rubber Cap 50mm modified in 3.(25) to the position of the air cleaner where the resonator was removed in 3.(23).





(27) Cut off ⑫air cleaner duct removed in 2.(14) along the dotted line shown in the diagram below.

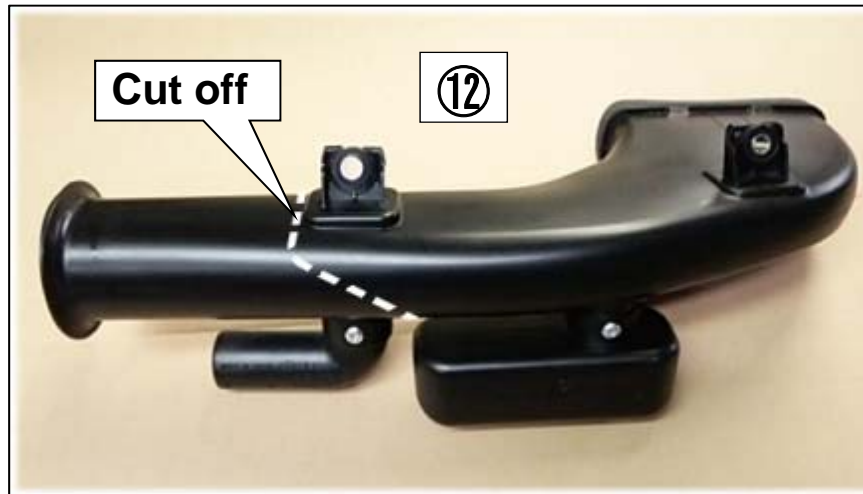

**NOTE**

✧ If you use “HKS AIR INTAKE DUCT ZN6/ZC6 FA20 P/N70999-AT001”, this step does not need.

(28) Cut the blow-by hose at 15mm from the end as shown in the diagram below.

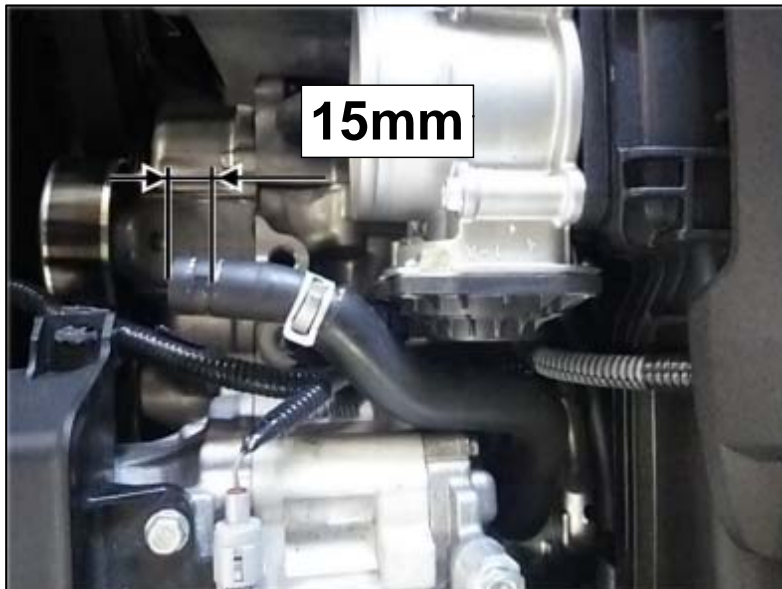

(29) Cut off ⑯oil level gauge bracket removed in 2.(18) at 40mm from the part's side as shown in the diagram below.

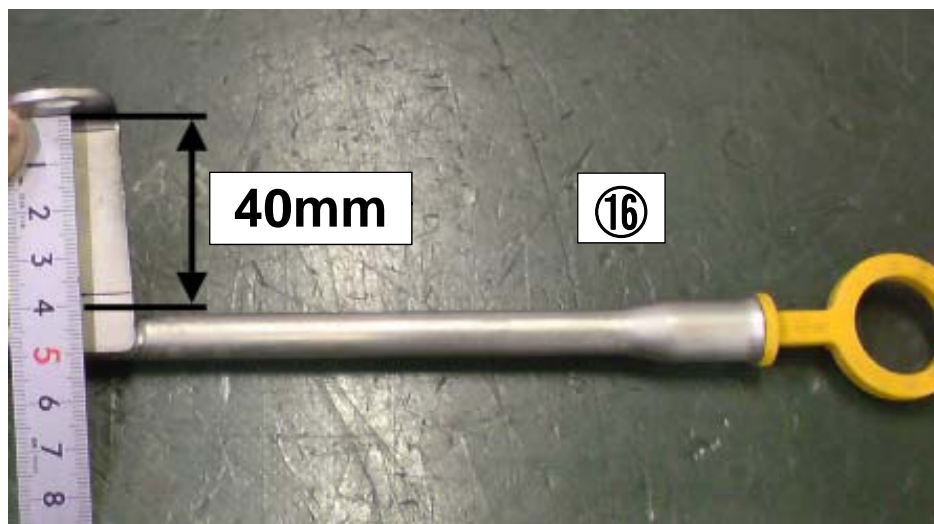

(30) Remove the installation bolt from the A/C compressor. Move the compressor slightly so there is adequate space for installation function under the intake manifold.

**NOTE**

✧ Do not disconnect the piping.

(31) Remove the installation bolt from the throttle body. Move the throttle body slightly so there is adequate space for installation function under the intake manifold.

**NOTE**

✧ Do not disconnect the water piping.

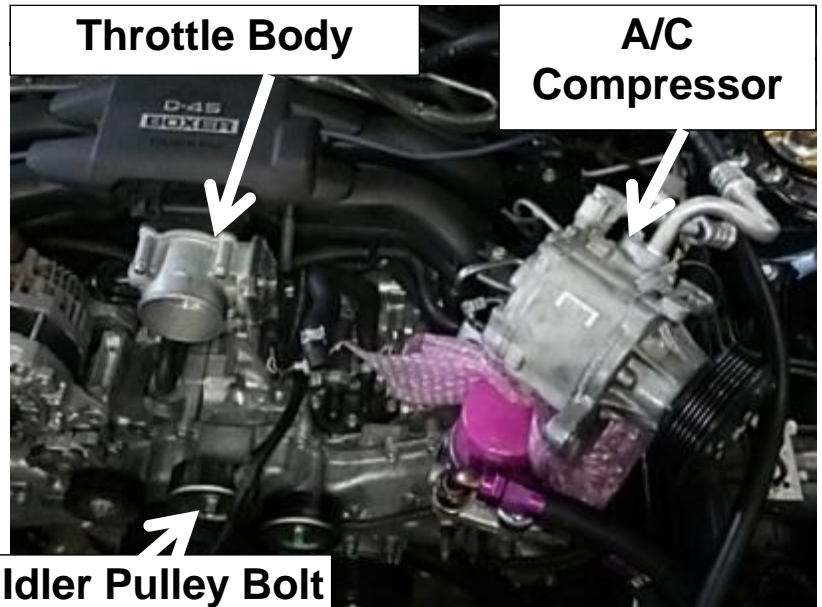

(32) Loosen the Idler Pulley Bolt.

**NOTE**

✧ Make sure not to remove the bolt even though the bolt will be replaced later. If the bolt is completely removed, the idler pulley may be fallen off.

(33) Cut the polystyrene form to make the air intake space.

(34) Fix the Polystyrene form with tape.

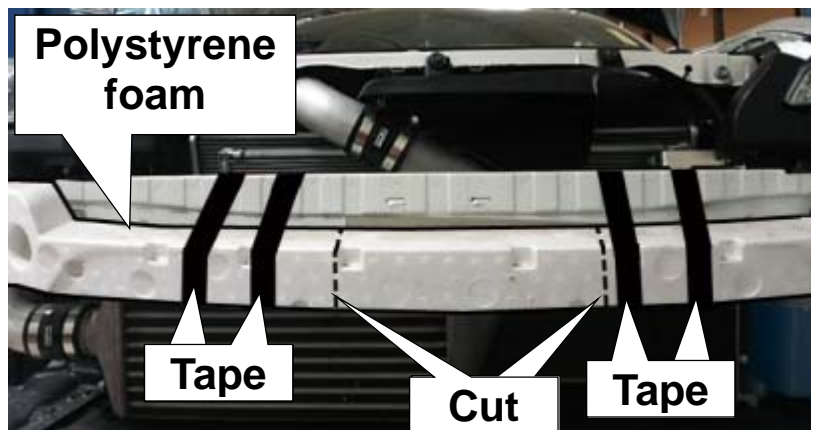

(35) Remove the canister purge solenoid from the intake manifold., Install the Hose Clamps as shown in the diagram on the right.

- P56 Hose Clamp 13.0mm x 1
- P57 Hose Clamp 11.5mm x 3

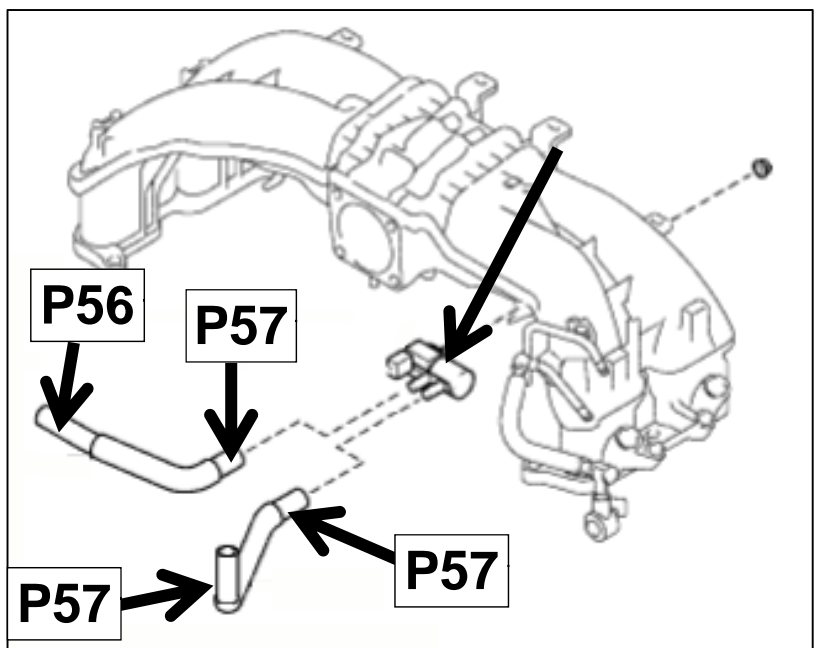

(36) Reinstall the canister purge solenoid. Place the throttle body and A/C compressor back in place.

(37) Install the Hose Clamps to the blow-by hose.

- P53 Hose Clamp 18.0mm x 1
- P55 Hose Clamp 13.8mm x 1

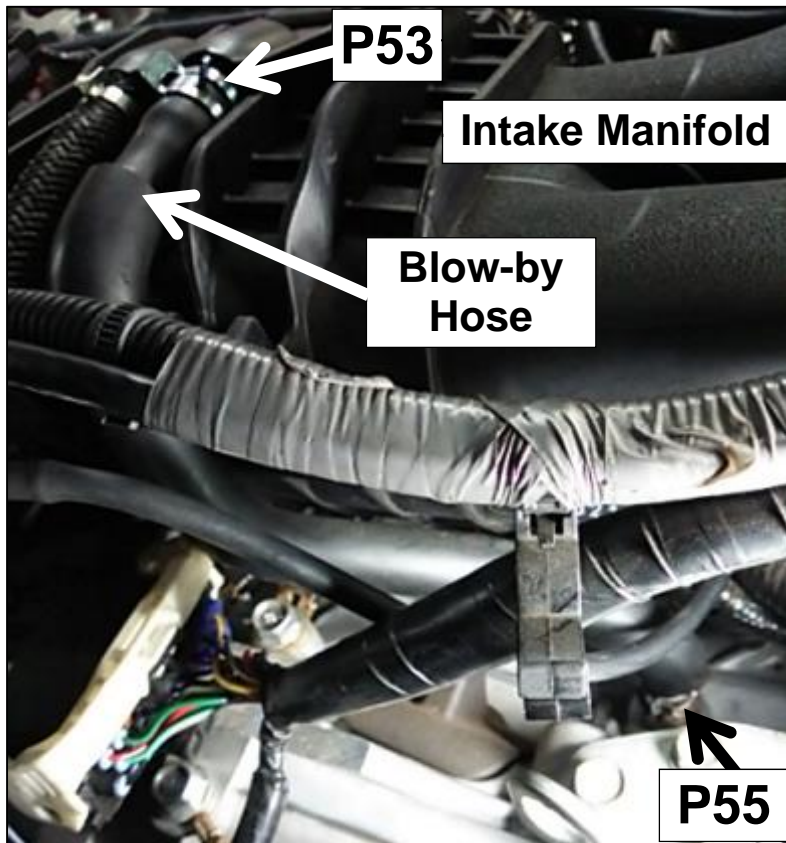

(38) Cut the front bumper removed in 2.(4) along the dotted line shown in the diagram on the right.

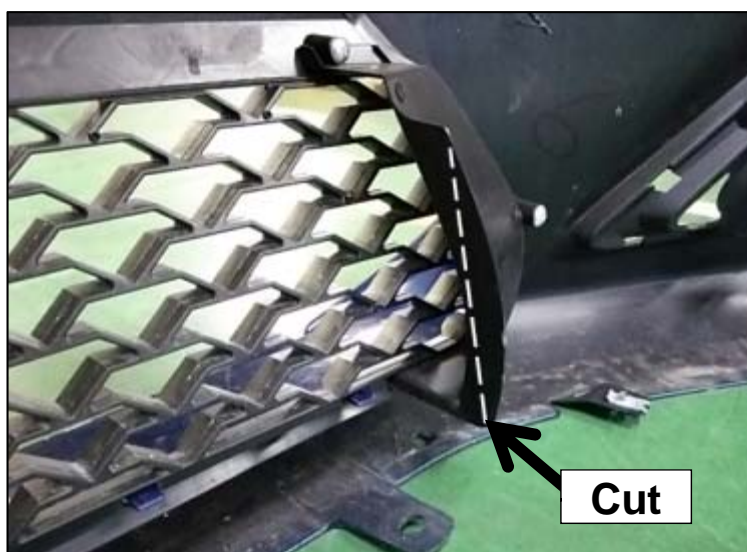

(39) Install the Corrugated Tube 10mm to the harness under the right side of the head light using the Tie Wraps (M).

- P40 Corrugated Tube 10mm x 1
- P77 Tie Wrap (M) x 2

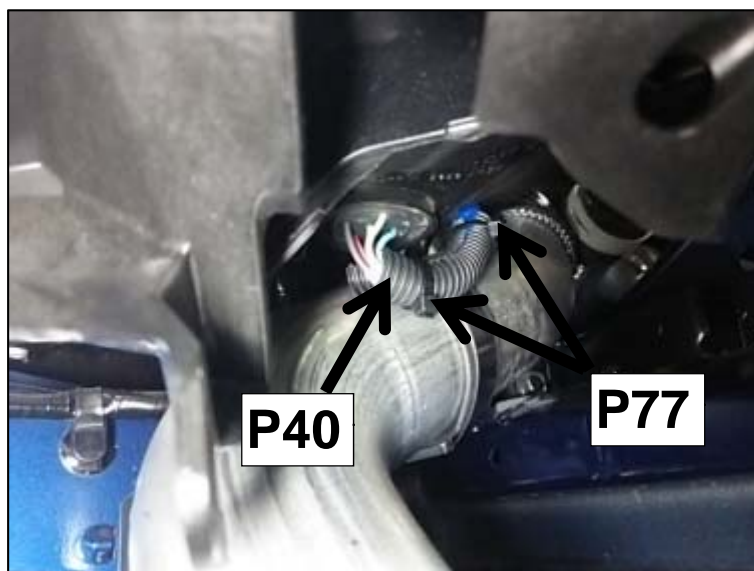



## 4. INSTALLATION OF GT2 SUPERCHARGER

PARTS LIST		
NO	DESCRIPTIONS	QT
P1	GT2 Supercharger	1
P2	S/C Pulley	1
P3	S/C Bracket No.1	1
P4	S/C Bracket No.2	1
P5	S/C Bracket Spacer No.1	2
P6	S/C Bracket Spacer No.2	1
P7	S/C Bracket Spacer No.3	1
P8	S/C Bracket Spacer No.4	1
P9	V-ribbed Belt	1
P41	Oil Level Gauge Clamp	1
P59	Cap Bolt M10 L50	1
P60	Cap Bolt M10 L45	1
P61	Cap Bolt M8 L125	1
P62	Cap Bolt M8 L115	1
P63	Cap Bolt M8 L90	1
P64	Cap Bolt M8 L20	2
P65	Cap Bolt M6 L55	2
P67	Dish Bolt M8 L35	3
P72	Low Head Cap Bolt M6 L12	5

(1) Temporarily install the Cap Bolt M8 L90 to the S/C Bracket.

- P3 S/C Bracket No.1 x 1
- P63 Cap Bolt M8 L90 x 1

### NOTE

- ✧ The Cap Bolt M8 L90 cannot be installed after GT2 Supercharger is installed to the S/C Bracket.

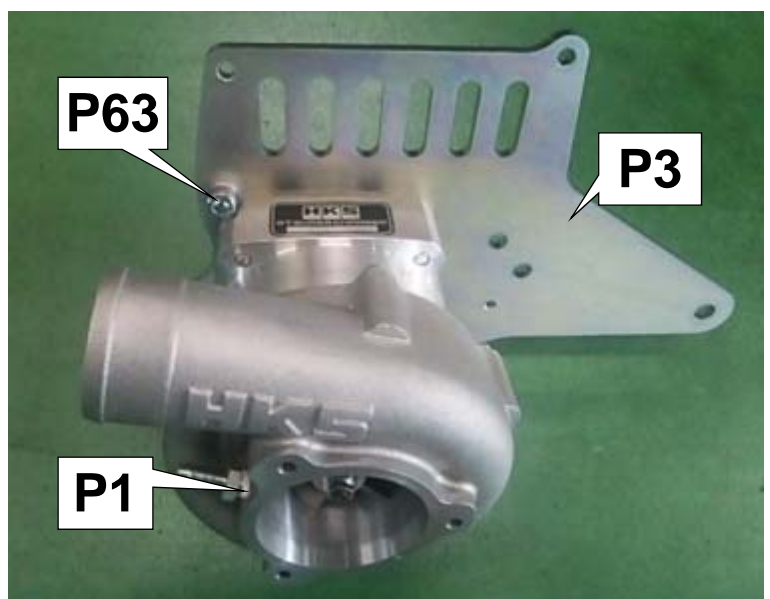

- (2) Install the GT2 Supercharger to the S/C Bracket No.1.
- P1 GT2 Supercharger x 1
  - P3 S/C Bracket No.1 x 1
  - P67 Dish Bolt M8 L35 x 3

**NOTE**

- ✧ Make sure the Cap Bolt M8 L90 temporarily installed in (2) moves freely.

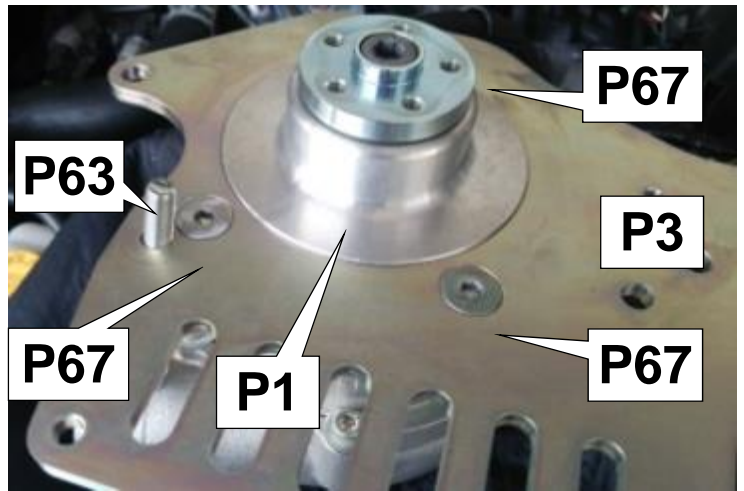

**⚠ CAUTION**

※ Head of Dish Bolt M8 L35(P67) position of the figure please confirm that no protruding from Supercharger Bracket No.1(P3). If the head of Dish Bolt M8 L35(P67) is projecting, the seating surface of the S / C Bracket Spacer No.2(P6) will be incorrect. In that case, please shave so as not to protrude the head of Dish Bolt M8 L35(P67).

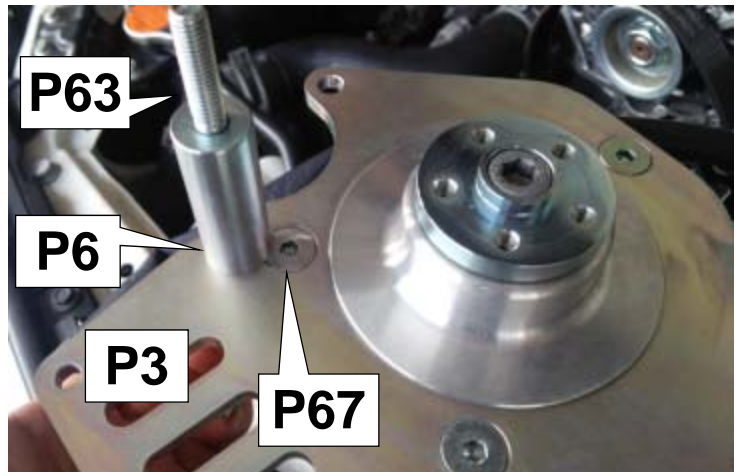

- (3) Install the Pulley to the GT2 Supercharger
- P2 S/C Pulley x 1
  - P72 Low Head Cap Bolt M6 L12 x 5

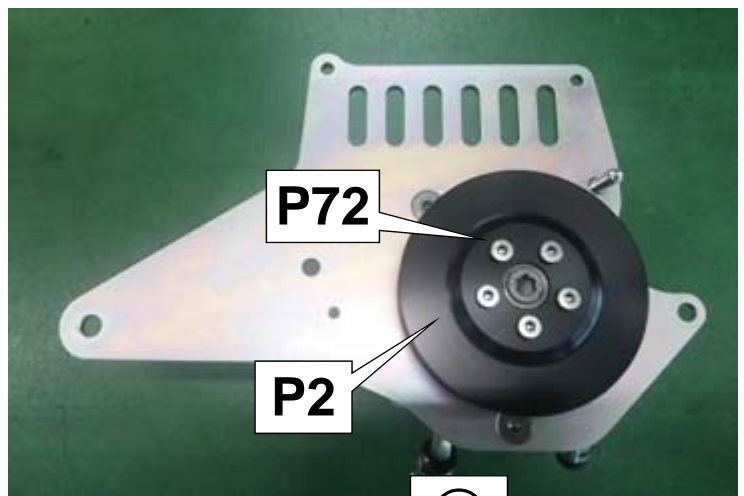

- (4) Install S/C Bracket No.2 to ⑳alternator and ㉓alternator bracket.
- P4 S/C Bracket No.2 x 1
  - P60 Cap Bolt M10 L45 x 1
  - P61 Cap Bolt M8 L125 x 1

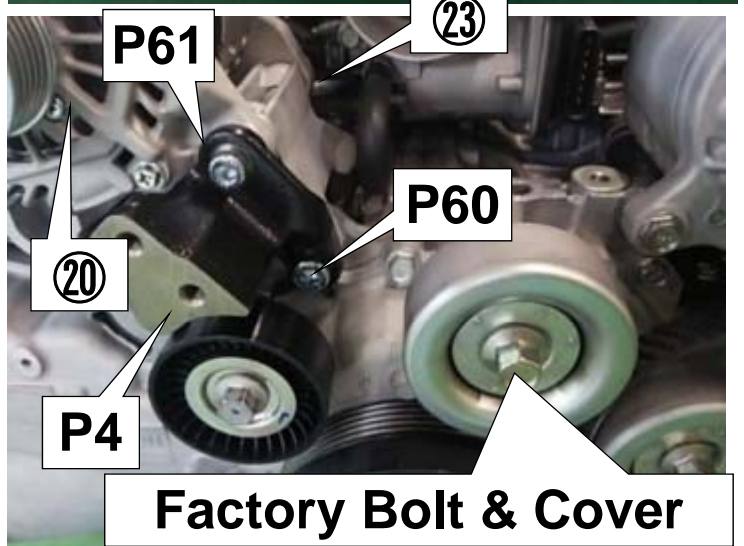

- (5) Remove the Idler Pulley Bolt loosened in 3. (32).

**NOTE**

- ✧ Reuse the cover between the bolt and pulley.
- ✧ Make sure not to drop the idler pulley.

(6) Wrap the V-ribbed Belt around the S/C Pulley.

- P9 V-ribbed Belt x 1

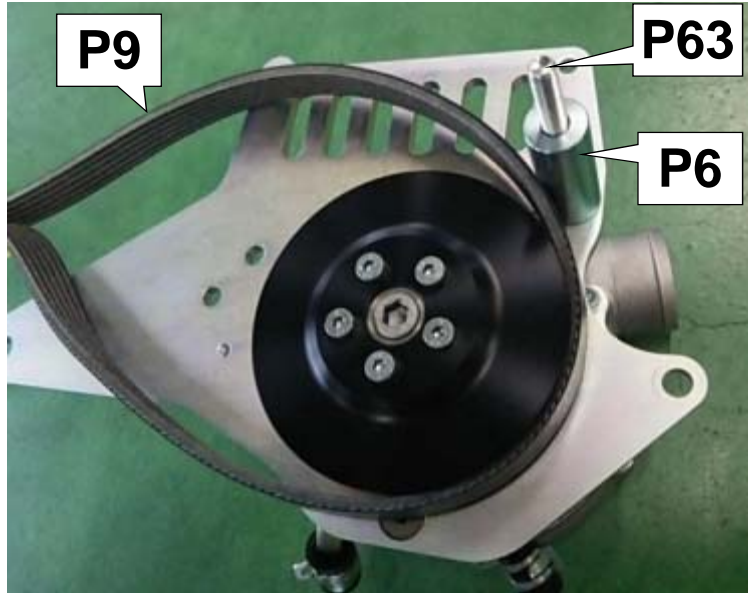

(7) Temporarily install the S/C Bracket Spacer No.2 to Cap Bolt M8 L90.

- P6 S/C Bracket Spacer No.2 x 1  
(φ 20-8 L52.3)

(8) Temporarily install the S/C Bracket No.1 to the engine and S/C Bracket No.2 using the Cap Bolt M8 L20 and Cap Bolt M8 L90.

- P64 Cap Bolt M8 L20 x 2

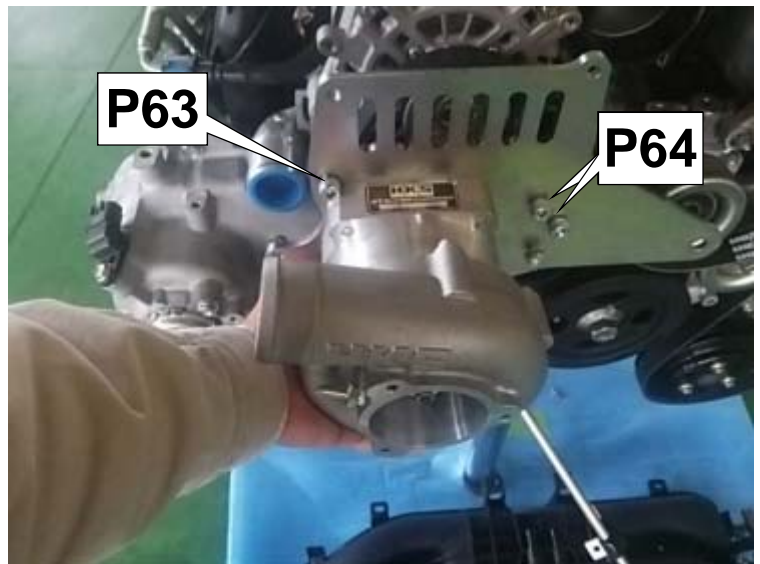

**NOTE**

- ◇ Make sure not to drop the idler pulley.
- ◇ Temporarily tighten the Cap Bolt only by or 3-4 threads. If it is completely tightened, S/C Bracket Spacers cannot be installed.
- ◇ Temporarily install the belt to \* 2:Alternator, \* 3:Auto Tensioner, and \* 7:Idler since the V-ribbed Belt cannot be installed after the Supercharger is installed to the engine.

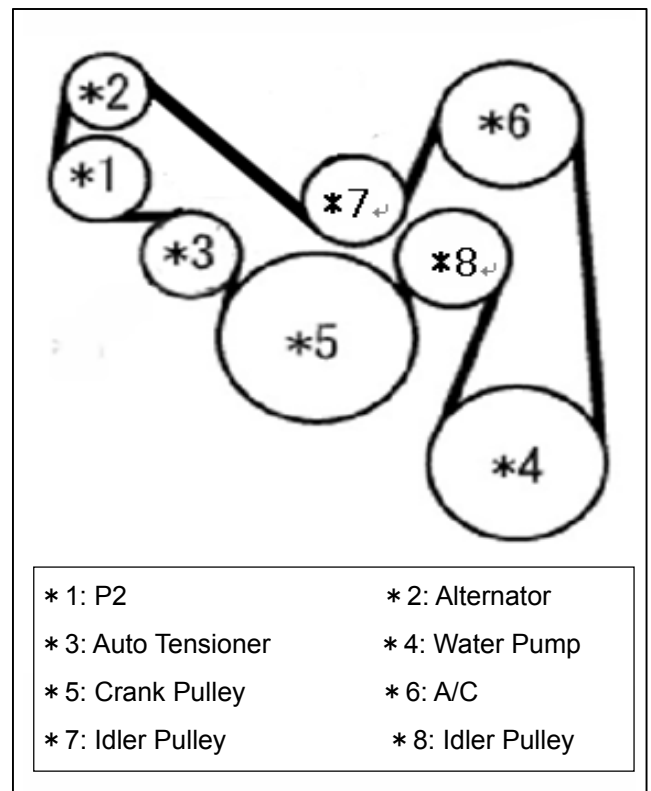



(9) Temporarily install the S/C Bracket Spacer No.1, No.3, and No.4.

- P5 S/C Bracket Spacer No.1 x2 (φ16-6 L36.2)
- P7 S/C Bracket Spacer No.3 x1 (φ16-8 L82.8)
- P8 S/C Bracket Spacer No.4 x1 (φ23-10 L10.6)
- P59 Cap Bolt M10 L50 x1
- P62 Cap Bolt M8 L115 X1
- P65 Cap Bolt M6 L55 X2

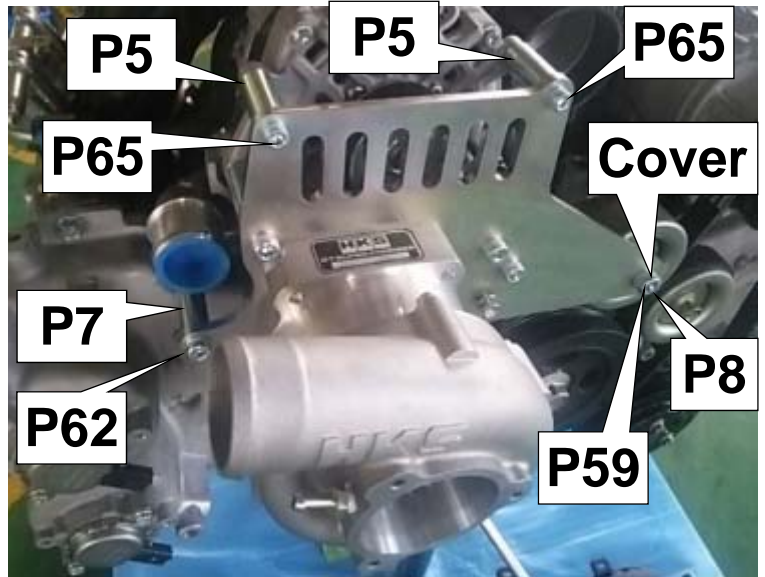

**NOTE**

✧ Insert the cover between the S/C Bracket No.4 and Idler Pulley.

(10) Tighten each Cap Bolt little by little, and tighten the S/C Bracket No.1 completely.

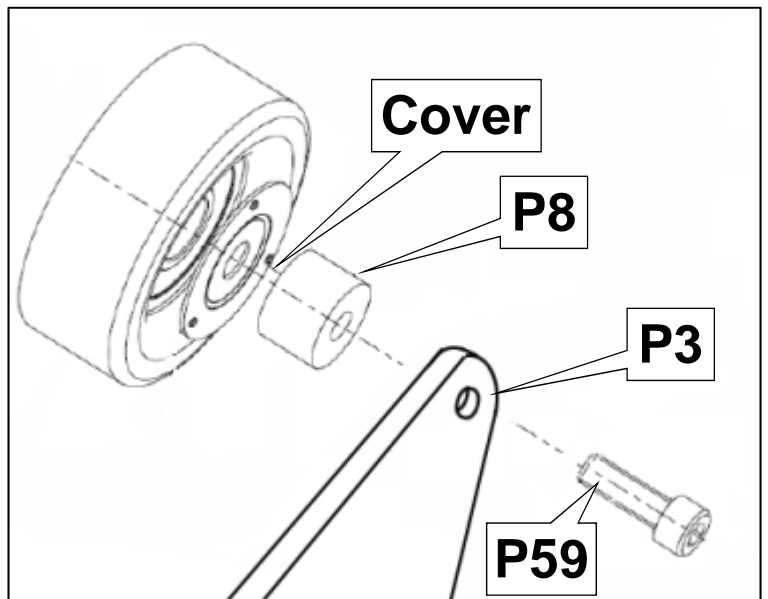

(11) Install the V-ribbed belt.

**CAUTION**

- Make sure the V-ribbed belt is installed properly. Improper installation may cause damage to the belt when the engine is started.
- Rotate the crank pulley so the belt is positioned properly.

(12) Install ⑩ oil level gauge modified in 3.(29) to the Supercharger Bracket and engine using the Oil Level Gauge Clamp.

- P41 Oil Level Gauge Clamp x 1

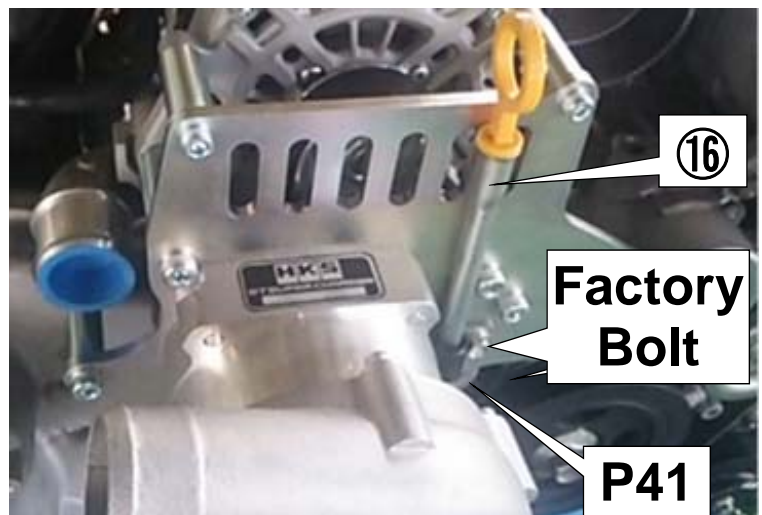

# 5. INSTALLATION OF INTERCOOLER

## PARTS LIST

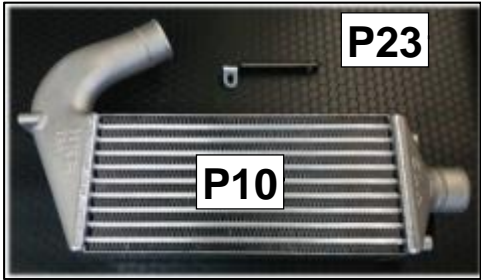
	NO	DESCRIPTIONS	QT
	P10	Intercooler	1
P23	Intercooler Bracket No.2	1	
P64	Cap Bolt M8 L20	4	
P73	Flat Washer M8	4	
P75	Flange Nut M8	1	

(1) Loosen 4 installation bolts of the A/C condenser.

**NOTE**

- ✧ The clearance between the A/C condenser and front bumper reinforcement can be wider so installation of the intercooler is easier.

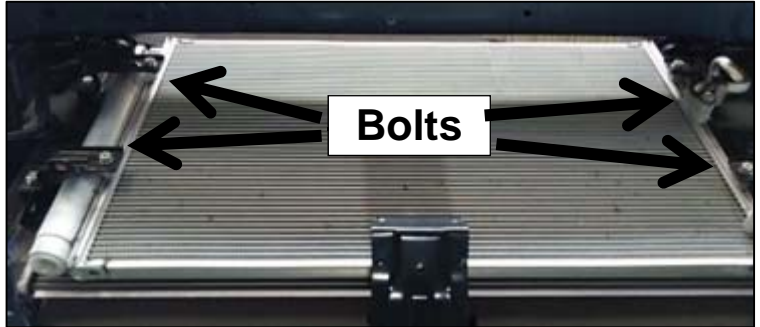

(2) Temporarily install the intercooler to the vehicle.

- P10 Intercooler x 1
- P23 Intercooler Bracket No.2 x 1
- P64 Cap Bolt M8 L20 x 4
- P73 Flat Washer M8 x 4
- P75 Flange Nut M8 x 1

**NOTE**

- ✧ Push the A/C condenser to rearward of the vehicle to widen the clearance; then, install the intercooler.

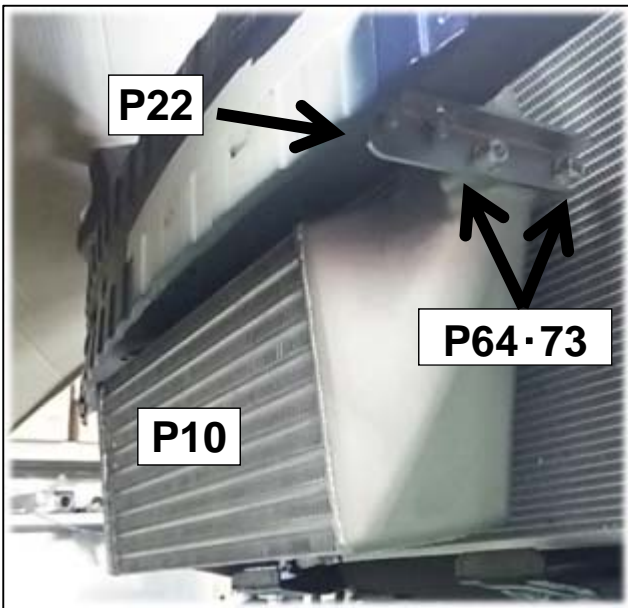

(3) Make sure the intercooler does not come in contact with any other parts of the vehicle. Tighten all bolts.

(4) Tighten the installation bolts of the condenser.



## 6. INSTALLATION OF TRACTION FLUID TANK

### PARTS LIST



NO	DESCRIPTIONS	QT
P18	Traction Fluid	1
P19	Traction Fluid Tank	1
P20	Traction Fluid Filter	1
P21	Traction Fluid Cooler	1
P25	Traction Fluid Filter Bracket	1
P26	Traction Fluid Cooler Bracket No.1	1
P27	Traction Fluid Cooler Bracket No.2	1
P31	Silicone Hose 55mm L43	1
P35	Traction Fluid Hose 9mm	1
P36	Traction Fluid Hose 8mm	1
P39	Corrugated Tube 15mm	1
P50	Hose Clamp #36	1
P54	Hose Clamp 15.5mm	4
P56	Hose Clamp 13.0mm	4
P69	Hexagon Bolt M8 L20	5
P70	Hexagon Bolt M6 L20	2
P73	Flat Washer M8	5
P74	Flat Washer M6 Major Dia.	2
P75	Flange Nut M8	3
P76	Flange Nut M6	2
P77	Tie Wrap (M)	5

### NOTE

- ✧ The Supercharger unit is made with precision components. If any foreign objects should become mixed with the traction fluid, the Supercharger may become damaged. Make sure the hoses and/or fitting ends are covered to prevent foreign objects from getting inside the hoses, tank and/or cooler.
- ✧ Refer to the diagram below for connecting the traction fluid tank, cooler, and supercharger. Make sure to connect all parts properly.

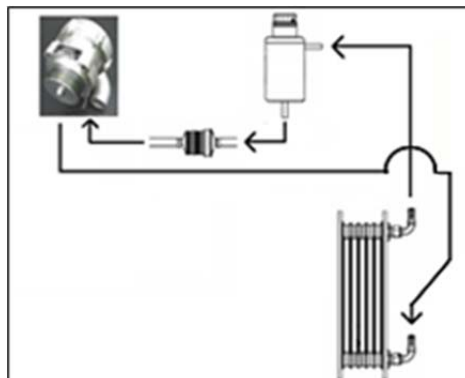

- (1) Cut the Traction Fluid Hose 9mm to ①200mm and ②260mm.
  - P35 Traction Fluid Hose 9mm x 1
- (2) Cut the Corrugated Tube 15mm to ①130mm, ②870mm, and ③690mm.
  - P39 Corrugated Tube 15mm x 1
- (3) Cut the Traction Fluid Hose 8mm to ①940mm and ②750mm.
  - P36 Traction Fluid Hose 8mm x 1
- (4) Install the Silicone Hose 55mm L43 to the Traction Fluid Filter.
  - P20 Traction Fluid Filter x 1
  - P31 Silicone Hose 55mm L43 x 1

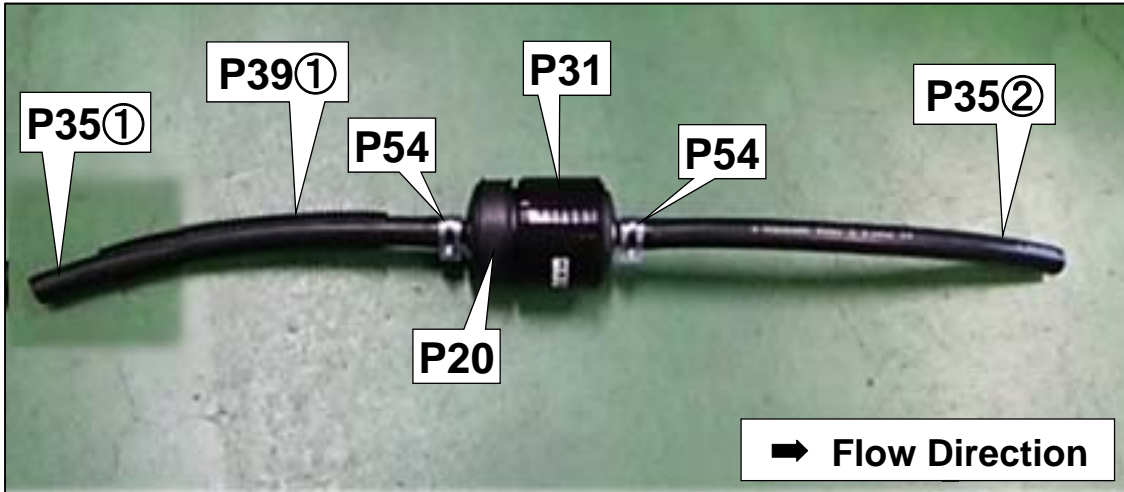

- (5) Install the Traction Fluid Hose 9mm ① and ② to the Traction Fluid Filter using the provided Hose Clamp 15.5mm.
  - P54 Hose Clamp 15.5mm x 2

**NOTE**

✧ Make sure to install the traction fluid filter in the correct direction. The arrow on the filter indicates the direction.

- (6) Install the Corrugated Tube ① to the Traction Fluid Hose 9mm ①.

- (7) Remove 2 of M6 bolts securing the GT2 Supercharger's compressor. Install the Traction Fluid Filter Bracket.

- P25 Traction Fluid Bracket x 1

**NOTE**

✧ Do not use the major diameter washer securing the compressor housing.



(8) Install the Traction Fluid Filter to the Traction Fluid Filter Bracket.

- P50 Hose Clamp #36 x 1

(9) Install the Traction Fluid Hose 9mm ② to the GT2 Supercharger.

- P54 Hose Clamp 15.5mm x 1

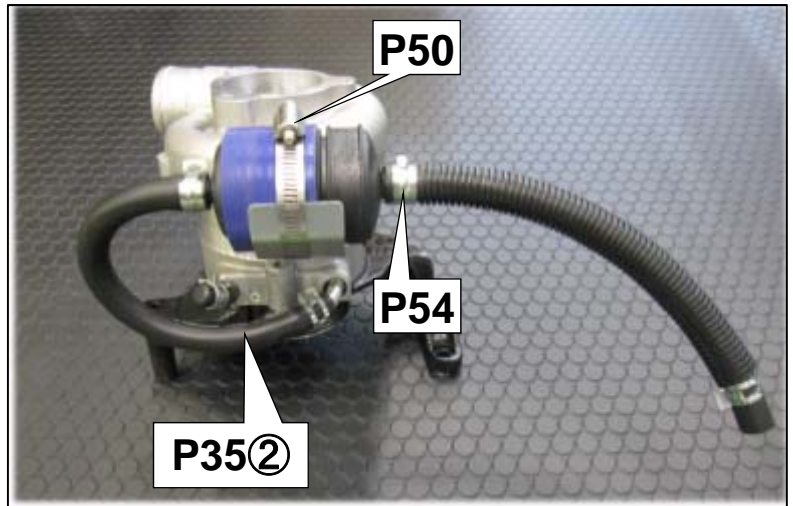

(10) Install the Traction Fluid Hose 8mm ① and ② to the Traction Fluid Cooler.

- P56 Hose Clamp 13.0mm x 2

(11) Install the Corrugated Tube 15mm ② and ③ to the Traction Fluid Hose 8mm ① and ②.

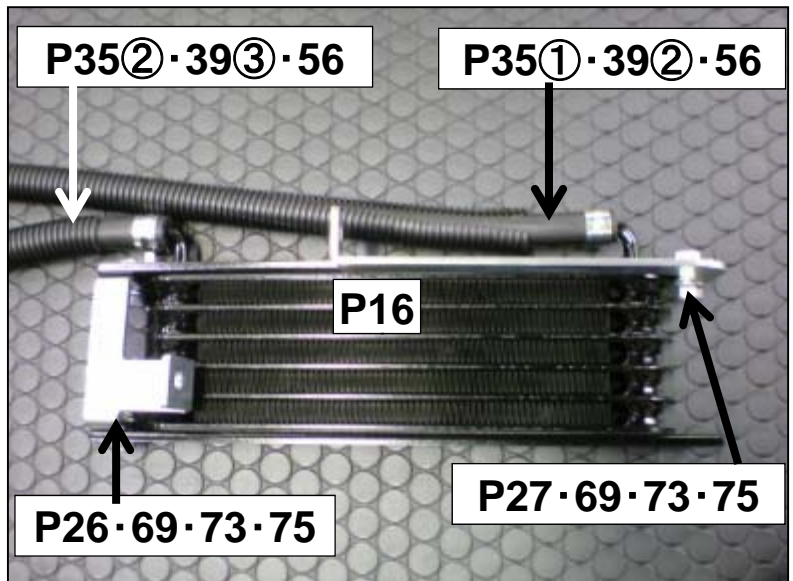

(12) Temporarily install the Traction Fluid Cooler Bracket to the Traction Fluid Cooler using the following provided parts.

- P21 Traction Fluid Cooler x 1
- P26 Traction Fluid Cooler Bracket No.1 x 1
- P27 Traction Fluid Cooler Bracket No.2 x 1
- P69 Hexagon Bolt M8 L20 x 3
- P73 Flat Washer M8 x 3
- P75 Flange Nut M8 x 3

(13) Temporarily install the Traction Fluid Cooler Bracket No.2 to the front bumper reinforcement using the following provided parts.

- P70 Hexagon Bolt M6 L20 x 1
- P74 Flat Washer M6 M. Dia. x1
- P76 Flange Nut M6 x 1





(14) Temporarily install the Traction Fluid Cooler Bracket No.1 to the front bumper reinforcement using the following provided parts.

- P70 Hexagon Bolt M6 L20 x 1
- P74 Flat Washer M6 M. Dia. x 1
- P76 Flange Nut M6 x 1

(15) Make sure the installed parts do not come in contact with any other parts of the vehicle. Tighten all bolts temporarily installed in (12), (13), and (14).



(16) Install the Traction Fluid Tank to the ⑭ radiator support modified in 3.(14) using the following provided parts.

- P19 Traction Fluid Tank x 1
- P69 Hexagon Bolt M8 L20 x 2
- P73 Flat Washer M8 x 2

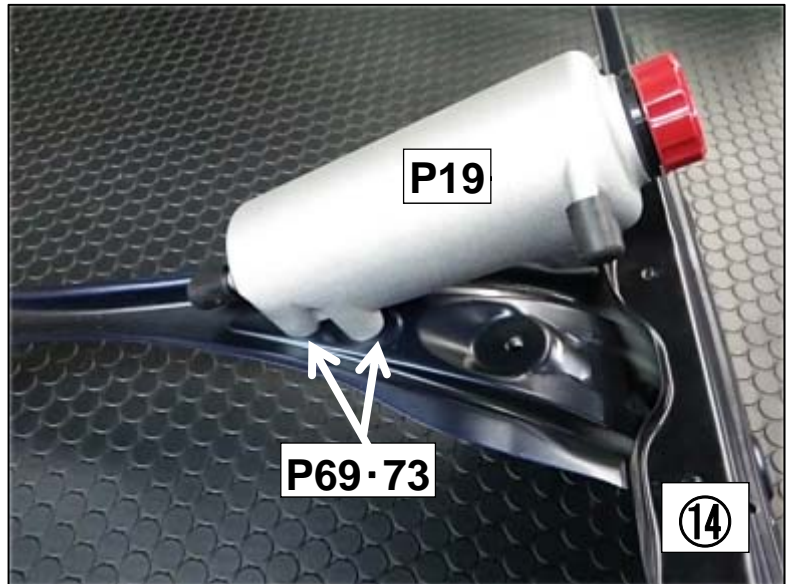

(17) Route the Traction Fluid Hose 8mm ② through the Radiator Support as shown in the diagram on the right. Temporarily install the Radiator Support to the vehicle.

**NOTE**

- ✧ For easier installation of the intercooler pipe, uplift the Radiator Support. Tighten bolts after installing the intercooler pipe.
- ✧ Route the hose inside of the Radiator Support.



(18) Install the Traction Fluid Hose 8mm ② to the attachment on the upper side of the Traction Fluid Tank.

- P56 Hose Clamp 13.0mm x 1



(19) Secure the Traction Fluid Hose 8mm ② to the Radiator Support in the position shown in the diagram above using the provided Tie Wraps (M). Pass the Tie Wraps through the holes made in 3.(14) and ones originally existed.

- P77 Tie Wrap (M) x 3

(20) Install the Traction Fluid Hose 9mm ① to the attachment on the lower side of the Traction Fluid Tank.

- P54 Hose Clamp 15.5mm x 1

(21) Install the Traction Fluid Hose 8mm ① to the GT2 Supercharger.

- P56 Hose Clamp 13.0mm x 1

(22) Secure the Traction Fluid Hose 8mm ① to the radiator fan shroud using the provided Tie Wraps (M).

- P77 Tie Wrap (M) x 2

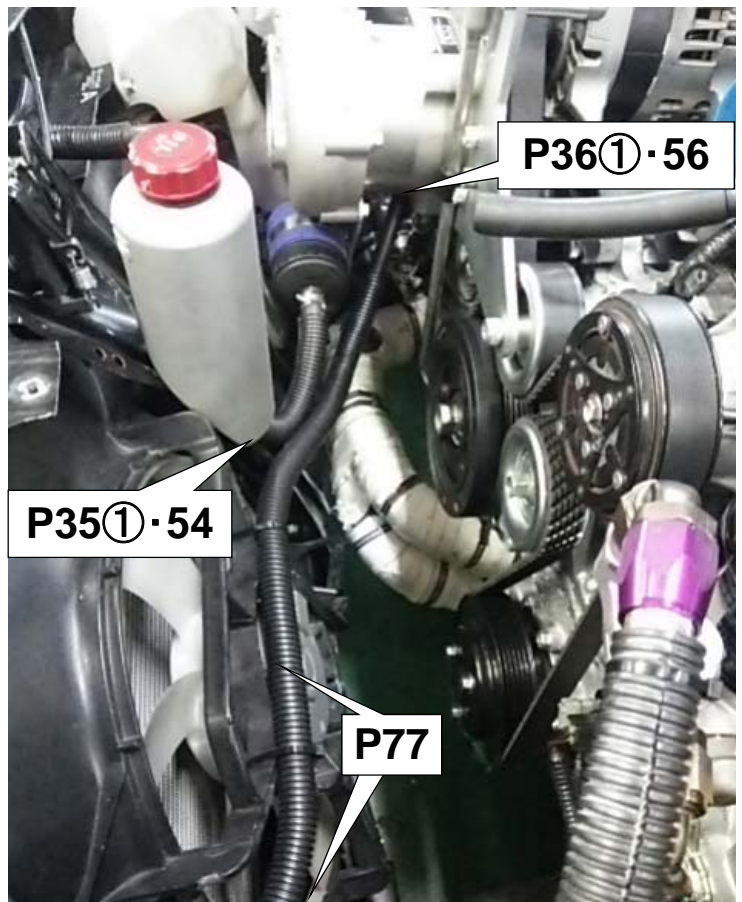



- (23) Make sure there are no foreign objects in the Traction Fluid Tank. Add the Traction Fluid up to the dotted line in the diagram. Close the cap properly and securely.
- P18 Traction Fluid x1

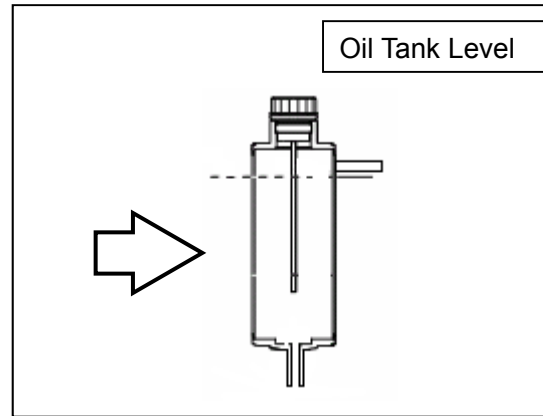

## 7. INSTALLATION OF SUCTION PIPE

PARTS LIST			
	NO	DESCRIPTIONS	QT
	P11	Suction Pipe	1
	P12	Suction Pipe Gasket	1
	P28	Silicone Hose 75mm L60	1
	P34	Silicone Hose 12mm-18mm	1
	P42	Joint Pipe 12mm	1
	P48	Hose Clamp #48	2
	P52	Hose Clamp 23.0mm	1
	P53	Hose Clamp 18.0mm	1
	P71	Flange Bolt M6 L18	3

(1) Temporarily install the Air Cleaner Case modified in 3. (23) to the vehicle

(2) Loosen the six M6capbolts that secure the compressor housing

**NOTE**

- ✧ In the next process, adjust the angle of the compressor housing .

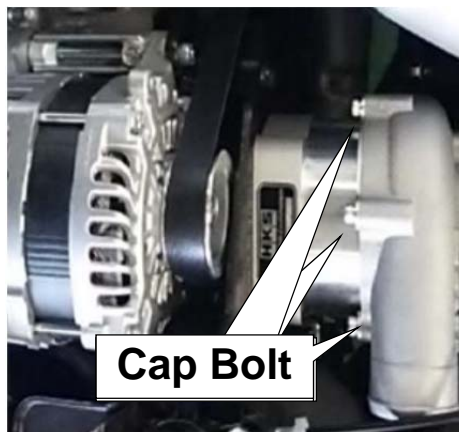

- (3) Adjust the angle of the compressor housing, And Install the Suction Pipe to the GT2 Super charger and air cleaner case.
- P11 Suction Pipe x 1
  - P12 Suction Pipe Gasket x 1
  - P28 Silicone Hose 75mm L60 x 1
  - P48 Hose Clamp #48 x 2
  - P71 Flange Bolt M6 L18 x 3

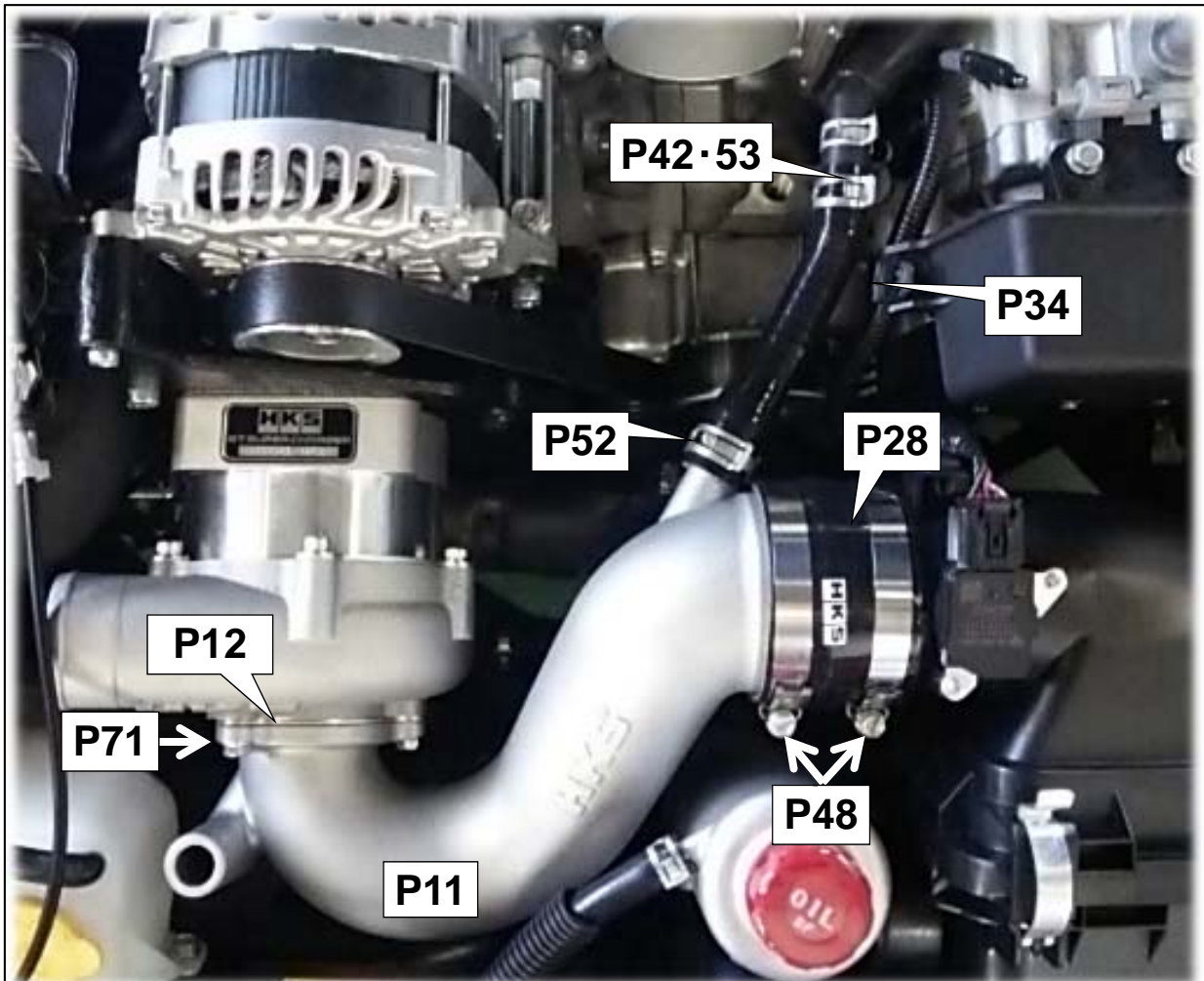

- (4) Fix the six M6capbolts that secure the compressor housing.
- (5) Install the Silicone Hose 12mm-18mm to the Suction Pipe and Blow-by Hose.
- P34 Silicone Hose 12mm-18mm x 1
  - P42 Joint Pipe 12mm x 1
  - P52 Hose Clamp 23.0mm x 1
  - P53 Hose Clamp 18.0mm x 1
- (6) Connect the airflow meter connector.
- (7) Tighten the bolts on the air cleaner case.

## 8. INSTALLATION OF INTERCOOLER PIPES

PARTS LIST		
NO	DESCRIPTIONS	QT
P13	Intercooler Inlet Pipe	1
P14	Intercooler Outlet Pipe No.1	1
P15	Intercooler Outlet Pipe No.2	1
P24	Intercooler Inlet Pipe Bracket	1
P29	Silicone Hose 75mm L55	1
P30	Silicone Hose 60mm L70	3
P32	Silicone Hose 50mm-60mm	1
P44	Spacer T=5	1
P45	Insulator Rubber	1
P48	Hose Clamp #48	2
P49	Hose Clamp #40	7
P50	Hose Clamp #36	2
P68	Hexagon Bolt M8 L25	1
P73	Flat Washer M8	1

(1) Temporarily install the Intercooler Inlet Pipe Bracket No.1 to the front bumper reinforcement in the position shown in the diagram on the right.

- P24 I/C Inlet Pipe Bracket x 1
- P44 Spacer T=5 x 1
- P68 Hex Bolt M8 L25 x 1
- P73 Flat Washer M8 x 1

### NOTE

- ✧ Insert the Spacer T=5 between the Intercooler Inlet Pipe Bracket and vehicle.

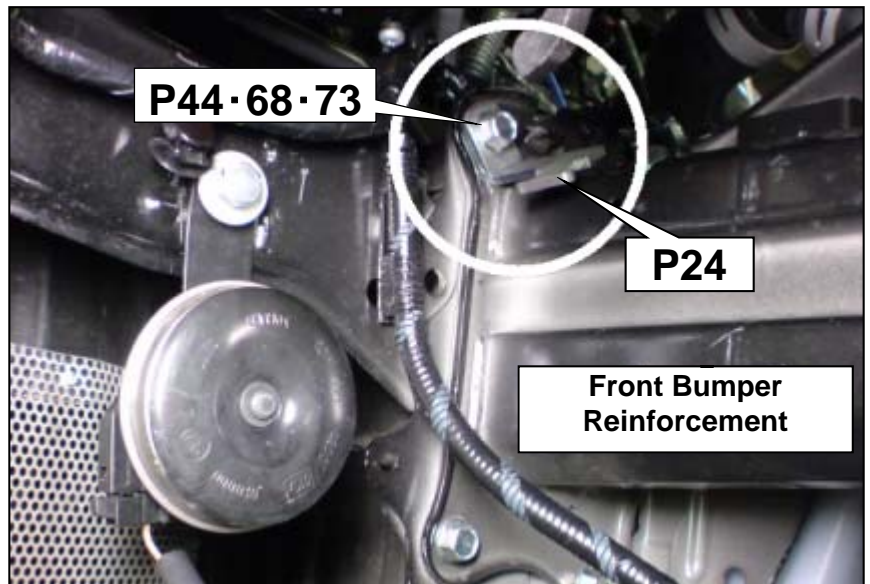



- (2) Temporarily install the Intercooler Inlet Pipe to the Intercooler.
- P13 I/C Inlet Pipe x 1
  - P30 Silicone Hose 60mm L70 x 1
  - P49 Hose Clamp #40 x 2

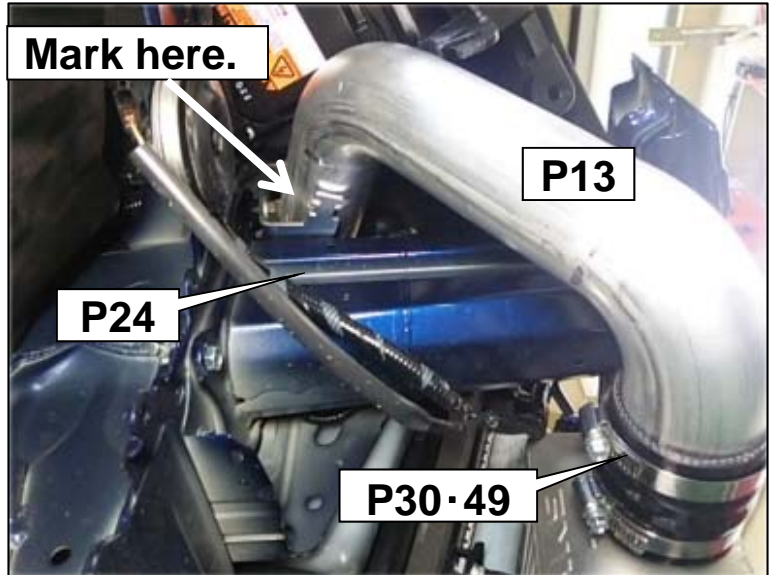

- (3) Mark the position where the Intercooler Inlet Pipe secures to the Intercooler Inlet Pipe Bracket. Remove the Intercooler Inlet Pipe.

- (4) Install the Insulator Rubber to the Intercooler Inlet Pipe.
- P45 Insulator Rubber x 1

**NOTE**

- ◇ For easier installation of the rubber, temporarily secure the rubber with tape.

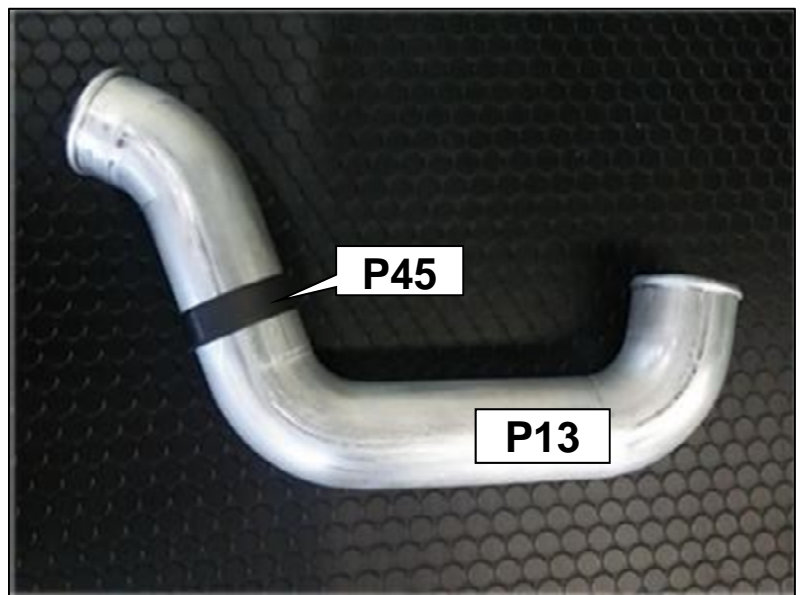

- (5) Tighten the bolt on the Intercooler Inlet Pipe Bracket.

- (6) Install the Intercooler Inlet Pipe to the Intercooler and secure the pipe to the Intercooler Inlet Pipe Bracket using the provided Hose Clamp #36.
- P50 Hose Clamp #36 x 1



(7) Install the Silicone Hose 50mm-60mm to the GT2 Supercharger and Intercooler Inlet Pipe.

- P32 Silicone Hose 50-60 x 1
- P49 Hose Clamp #40 x 1
- P50 Hose Clamp #36 x 1



(8) Install the Intercooler Outlet Pipe No.1 and No.2 to the Intercooler and throttle.

- P14 I/C Outlet Pipe No.1 x 1
- P15 I/C Outlet Pipe No.2 x 1
- P29 Silicone Hose 75mm L55 x 1
- P30 Silicone Hose 60mm L70 x 2
- P48 Hose Clamp #48 x 2
- P49 Hose Clamp #40 x 4

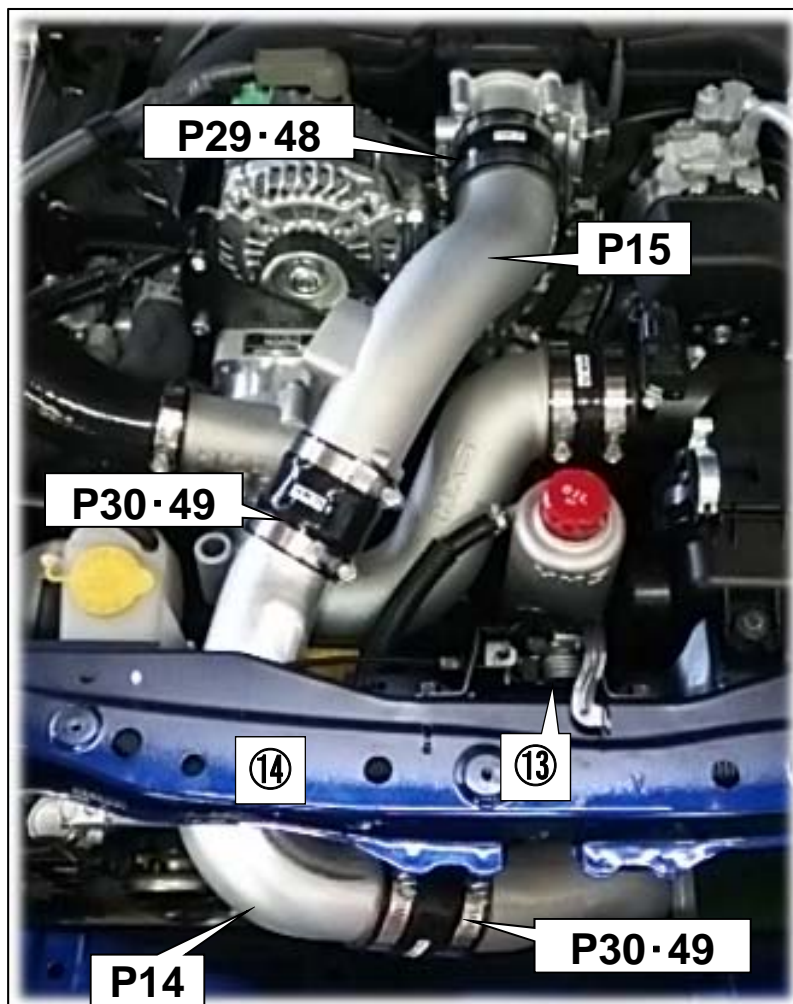

(9) Install ⑭ radiator support to the vehicle.

(10) Install ⑬ hood lock to the vehicle.

# 9. INSTALLATION OF BLOW-OFF VALVE

## PARTS LIST



**P16**

**P17**

**P33**

NO	DESCRIPTIONS	QT
P16	Blow-off Valve	1
P17	Blow-off Valve Gasket	1
P33	Silicone Hose 22mm	1
P37	Hose 10mm	1
P38	Hose 4mm	1
P43	T-fitting 10mm-4mm-10mm	1
P51	Hose Clamp 26.0mm	2
P54	Hose Clamp 15.5mm	2
P55	Hose Clamp 13.8mm	2
P56	Hose Clamp 13.0mm	1
P58	Hose Clamp 6.8mm	2
P77	Tie Wrap (M)	2

(1) Install the Blow-off Valve to the Intercooler Outlet Pipe No.2.

- P16 Blow-off Valve x 1
- P17 Blow-off Valve Gasket x 1

(2) Install the Silicone Hose 22mm to the Blow-off Valve and Suction Pipe.

- P33 Silicone Hose 22mm x 1
- P51 Hose Clamp 26.0mm x 2

**NOTE**

- ✧ Install the shorter straight side of the Silicone Hose 22mm to the Suction Pipe.



**P16**

**P33-51**

(3) Cut the Hose 4mm to 650mm in length.

- P38 Hose 4mm L1000 x 1



### For a Manual Transmission Vehicle:

(4) Install the Hose 4mm cut in 8.(3)to the T-fitting  
10mm-4mm-10mm.

- P43 T-fitting 10mm-4mm-10mm x 1
- P58 Hose Clamp 6.8mm x 1

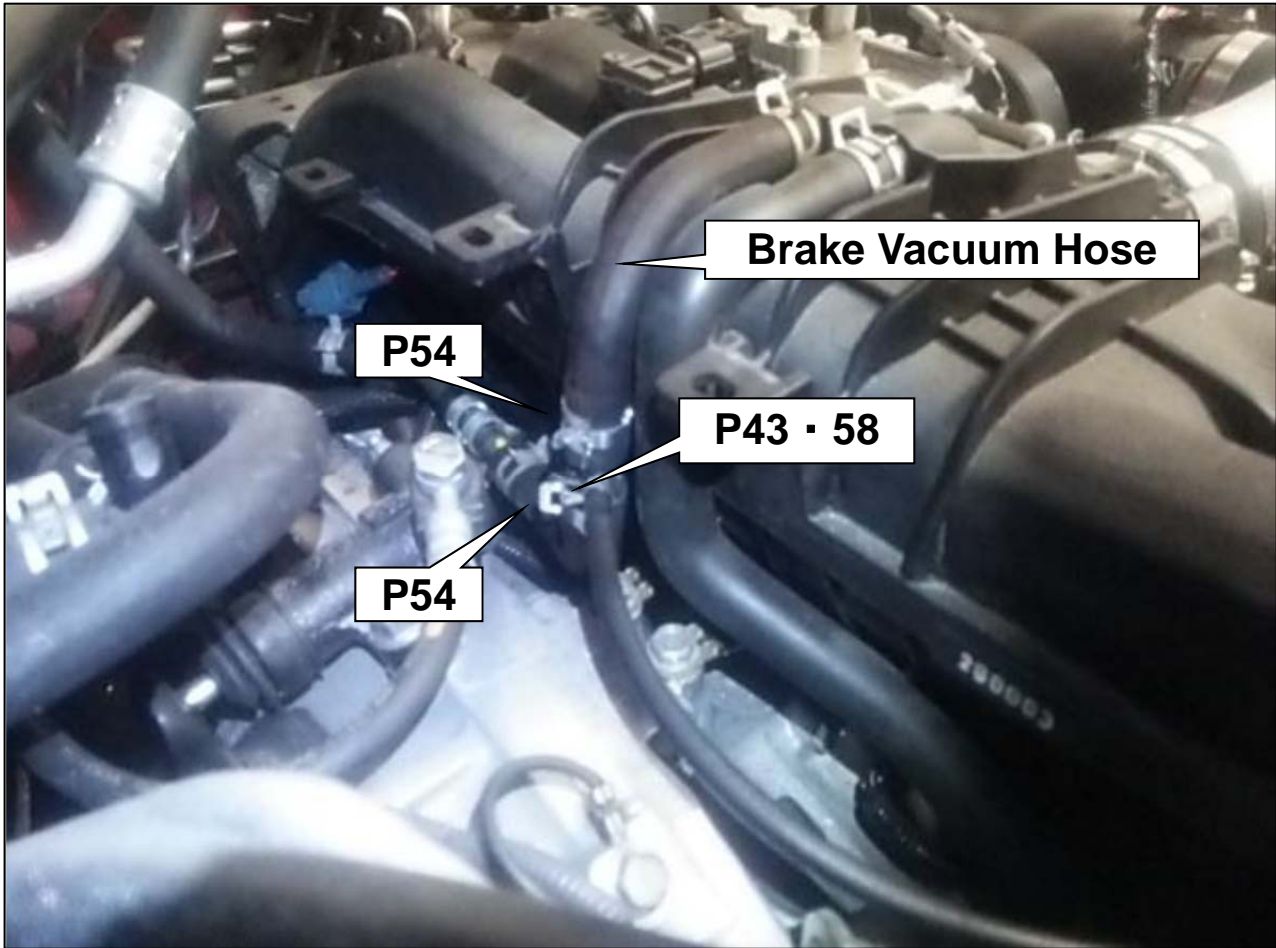

(5) Cut the brake vacuum hose and install the T-fitting 10mm-4mm-10mm to the brake vacuum hose.

- P54 Hose Clamp 15.5mm x 2

## For an Automatic Transmission Vehicle:

(6) Remove the engine cover.

(7) Remove the rubber cap.

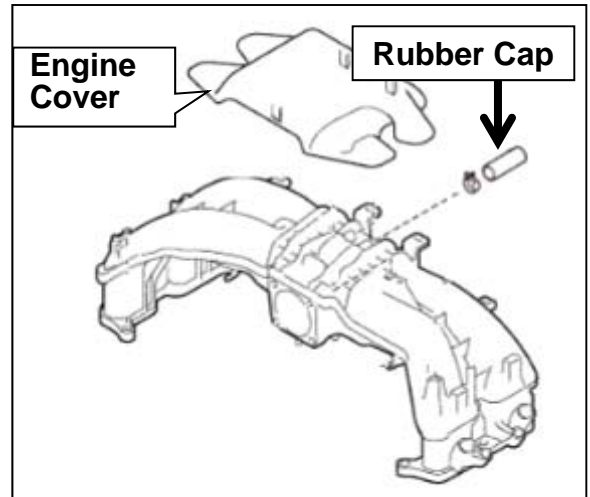

(8) Cut the Hose 10mm to 115mm in length.

- P37 Hose 10mm x 1

(9) Install the 650mm Hose 4mm, rubber cap removed in 8.(8), and 115mm Hose 10mm to the T-fitting 10mm-4mm-10mm.

- P43 T-fitting 10mm-4mm-10mm x 1
- P55 Hose Clamp 13.8mm x 2
- P56 Hose Clamp 13.0mm x 1
- P58 Hose Clamp 6.8mm x 1

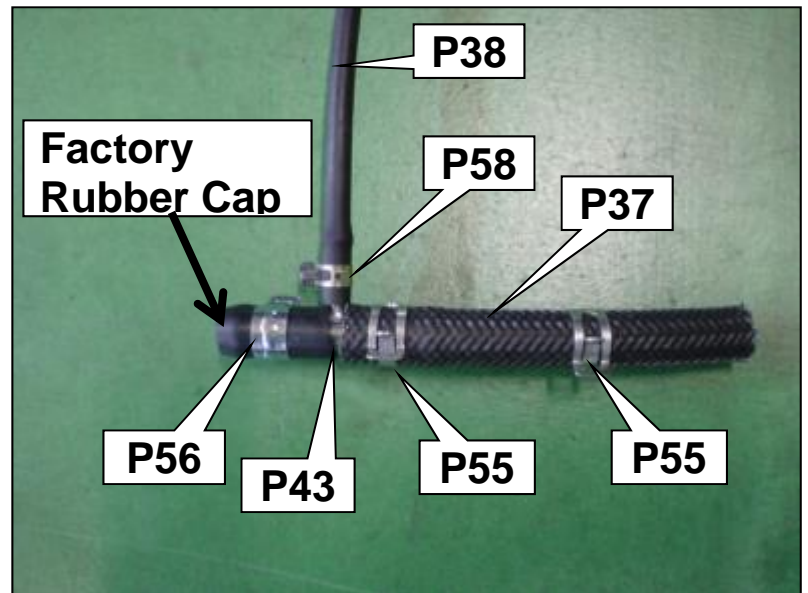

(10) Install the Hose 10mm to the intake manifold.



**The following procedures are for both manual and automatic transmission vehicles:**

(11) Install the Hose 4mm to the Blow-off Valve.

- P58 Hose Clamp 6.8mm x 1

**NOTE**

- ◇ Route the Hose 4mm under the intake manifold.

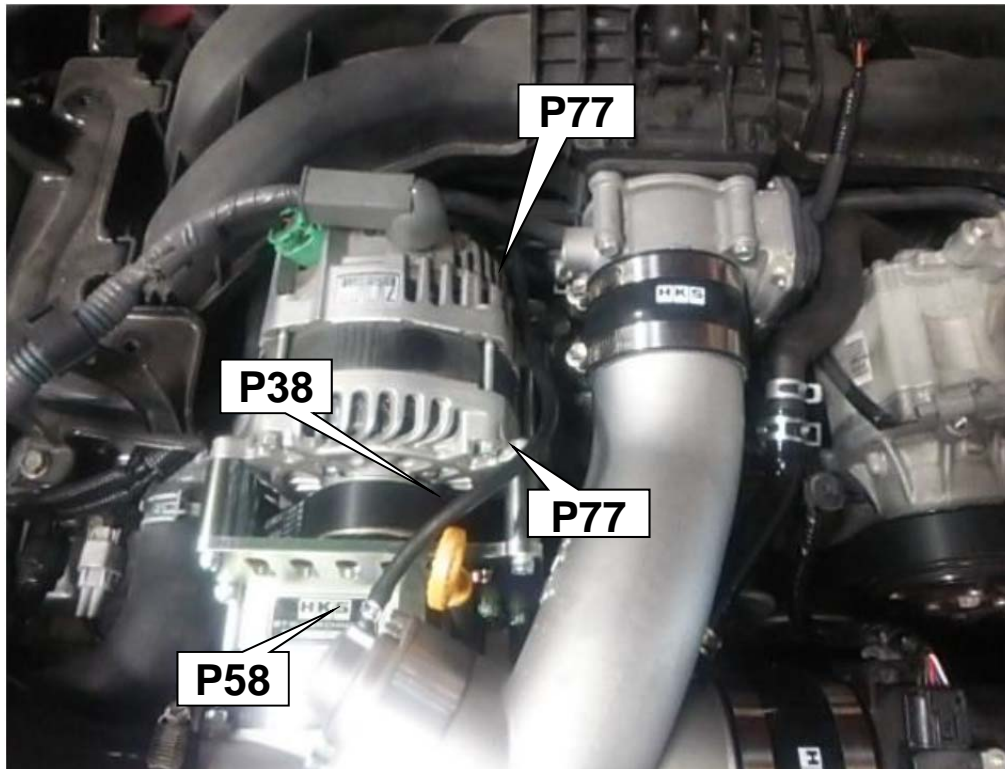

(12) Secure the Hose 4mm to the alternator using the provided Tie Wraps.

- P77 Tie Wrap (M) x 2

(13) Reinstall the engine cover to the engine.

(14) Relocate the sponge of the hood support rod to the position shown in the diagram on the right.

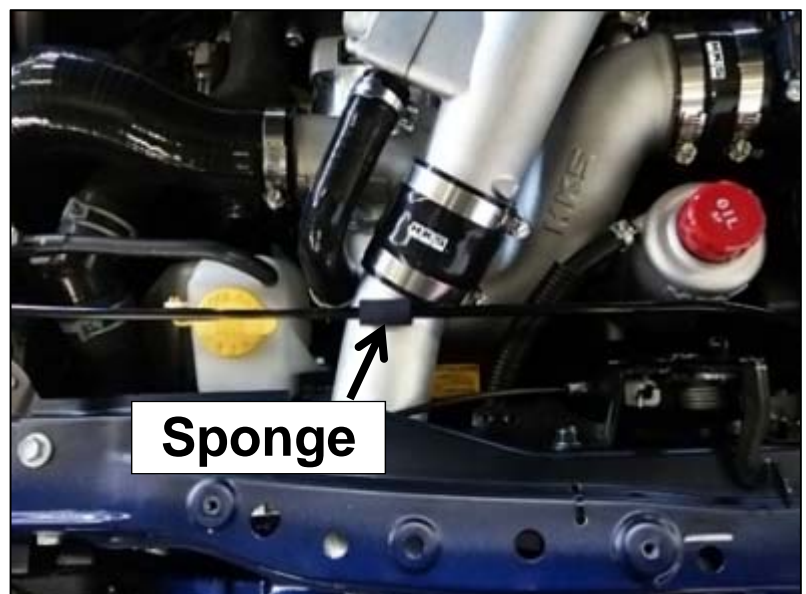

## 10. REINSTALLATION OF FACTORY PARTS

- (1) Reinstall ⑪ belt cover.
- (2) Reinstall ⑫ air duct.
- (3) Reinstall ⑧ front bumper bracket.
- (4) Reinstall ⑦ front bumper cover LWR.
- (5) Reinstall ③ front bumper energy absorber.
- (6) Reinstall ② front bumper.
- (7) Reinstall ① left and right side turn signal lights.
- (8) Reinstall the engine under cover.
- (9) Reconnect the negative terminal to the battery.

## 11. CONFIRMATION AFTER INSTALLATION & FILLING TRACTION FLUID

Check the following after the installation process is complete.

(1) Check off the following before starting the engine:

	Items to confirm:	Check
1	Make sure the hose layout is correct.	
2	Make sure the wiring harnesses and installed components do not come in contact with any other parts on the vehicle.	
3	Make sure the harness is not pinched at any point.	
4	Make sure all bolts (especially the pulley bolts) are tightened properly.	
5	Make sure the belt is properly aligned with the grooves of the pulley.	
6	Make sure the Traction Fluid is at the correct level.	
7	Make sure all pipes and hoses are routed and connected correctly.	
8	Make sure hoses are not kinked or bent.	
9	Make sure all hose clamps are tight.	
10	Make sure all bolts and nuts are tightened.	
11	Make sure all installed components are secured.	
12	Make sure the negative cable terminal is securely attached to the battery.	
13	Make sure the engine oil level dipstick is between H – L.	

(2) Prepare Traction Fluid in a beaker or small container, open the oil cap and start the engine.

(3) Immediately after starting the engine, perform the following:

- a) Check to make sure that the oil level starts to decline, and then increase again.
- b) Add oil from a beaker or small container, so that the Oil Tank level does not get empty. Also make sure that the Oil Tank does not overflow.  
 ※There may be some unusual or unpleasant noises emanating from the Supercharger after starting the engine. This is normal, and this noise will go away after the Traction Fluid warms up (approximately 2-3 minutes).

(4) Start the engine and perform the following checks after the engine reaches normal operating temperature:

### NOTE

Do not raise the engine RPM while the engine is warming up; let it idle.

	Items to confirm:	Check
1	Make sure the Traction Fluid returns to the Oil Tank.	
2	Make sure there are no leaks in the fuel, Traction Fluid, coolant, or piping.	
3	Make sure there is no excessive stress on any harnesses, fuel lines or hoses.	
4	Make sure the installed parts do not come in contact with any other parts.	



(5) After verifying the above items, raise and keep the RPM stable at 2000RPM for 10 seconds. Immediately shut off the engine and check the Traction Fluid level. The level needs to be at level ① indicated in D18-2. If it is lower, add Traction Fluid as necessary.

**\*If there is excess Traction Fluid remaining in the bottle, replace the cap on the bottle and store in a safe location. Always store excess Traction Fluid in the original bottle to avoid damage to the bottle and/or degradation of the fluid.**

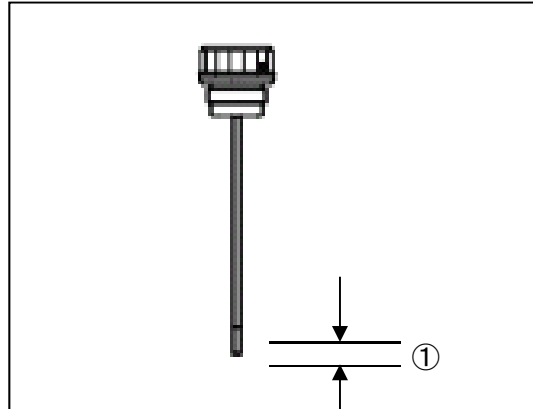

(6) Put the oil tank cap back on.

**The installation process is now complete**

※ After driving a while and stop the engine when the engine room is at high temperature, the belt may make squeaking noises. This is caused by the factory auto-tensioner's adjustment function; this is normal.

# 12. 1<sup>ST</sup> MONTH INSPECTION

## ○ Inspection

### 1. 1<sup>st</sup> Month Inspection

- Within 40 days of installation, it is recommended to consult your installer/retailer for the following 1<sup>st</sup> month inspection:
- If there is no trouble found after the inspection, fill out the registration form to register.

Entry Method	No Problem	<input checked="" type="checkbox"/>	Exchange	<input type="checkbox"/>	Adjust	A	Tighten	T
--------------	------------	-------------------------------------	----------	--------------------------	--------	---	---------	---

	Inspection Item
1	<p><u>Supercharger Unit Check</u></p> <div style="border: 1px solid black; padding: 5px; margin: 10px 0;"> <p style="text-align: center;"> <b>WARNING</b></p> <ul style="list-style-type: none"> <li>▪ When checking operation of the unit, avoid touching any moving belts, even clothing.</li> <li>▪ Touching these moving belts can lead to severe injury and damage.</li> </ul> </div> <p>Compare the operating sound currently against initial installation, check for increased sound levels or unusual noises. <span style="float: right;"><input type="checkbox"/></span></p> <p>Compare the sound of the air cleaner against initial installation, check for increased intake sound levels or unusual noises. <span style="float: right;"><input type="checkbox"/></span></p> <p>Check Traction Oil level for unusually high Traction Oil consumption. (Oil level surface is not touching the oil level gauge) <span style="float: right;"><input type="checkbox"/></span></p>
2	<p><u>Traction Oil Piping Inspection</u></p> <p>Check for Traction Oil leaking from the piping, loose hose clamps</p> <p>Locations:</p> <ul style="list-style-type: none"> <li>▪ Connection point to the Supercharger <span style="float: right;"><input type="checkbox"/></span></li> <li>▪ Connection point to the oil cooler <span style="float: right;"><input type="checkbox"/></span></li> <li>▪ Connection point to the oil tank <span style="float: right;"><input type="checkbox"/></span></li> <li>▪ Connection point to the oil filter <span style="float: right;"><input type="checkbox"/></span></li> </ul> <p>Signs of damage due to rubbing of the Traction Oil hose to other parts <span style="float: right;"><input type="checkbox"/></span></p> <p>Cracks or breaks in the Traction Oil hose <span style="float: right;"><input type="checkbox"/></span></p> <p>If Traction Oil filled to the marking level on the oil level gauge <span style="float: right;"><input type="checkbox"/></span></p>
3	<p><u>Belt Inspection</u></p> <p>Check if v-belt's tension is within the Auto-tensioner's adjusting range <span style="float: right;"><input type="checkbox"/></span></p> <p>Cracks or breaks in the belts. <span style="float: right;"><input type="checkbox"/></span></p>
4	<p><u>Bolt Tightening</u></p> <p>Check if Supercharger mounting bolt is tightened <span style="float: right;"><input type="checkbox"/></span></p> <p>Check if pulley mounting bolts are properly tightened <span style="float: right;"><input type="checkbox"/></span></p> <p>Check if pulley does not come in contact with any other parts of the vehicle. <span style="float: right;"><input type="checkbox"/></span></p>
5	<p><u>Other</u></p> <p>Check all mounted parts for interference with other parts</p> <p>Locations:</p> <ul style="list-style-type: none"> <li>▪ Suction pipe &amp; vehicle <span style="float: right;"><input type="checkbox"/></span></li> <li>▪ Traction Fluid Hose &amp; vehicle <span style="float: right;"><input type="checkbox"/></span></li> <li>▪ 4mm Hose from Blow-off Valve &amp; vehicle <span style="float: right;"><input type="checkbox"/></span></li> </ul> <p>Check if hose clamps are properly tightened <span style="float: right;"><input type="checkbox"/></span></p> <p>Check if engine oil level is between H-L <span style="float: right;"><input type="checkbox"/></span></p>

## 13. MAINTENANCE

- Traction Oil is used specifically for the HKS GT2 Supercharger. Do not use other types of oils; use of other brands of Traction Oil, engine oil, or transmission oil can lead to damage to the HKS GT2 Supercharger internals.
- Traction Oil does not need to be replaced, however check oil level prior to driving. If oil level is low, add Traction Oil as necessary.
  - Use the part number below to order Traction Oil.

Product Name	Part Number
Traction Fluid	12002-AK029

- Replace the Traction Oil Filter every 5 years or 70,000km after installing the HKS GT2 Supercharger.
  - Use the part number below to order the Traction Oil Filter.

Product Name	Part Number
Traction Fluid Filter	12002-AK015

- Belts are consumable parts. Always check belts prior to driving for any cracks or tears.
- Replace damaged belts immediately. Do not use other types of belt; use of other brands of belt may cause belt to squeal.
  - Use the part number below to order the Ribbed Belt.

Product Name	Part Number
V-ribbed Belt 6PK2160	12002-KK003

## 14. TROUBLE SHOOTING

- If this product does not perform properly, check all wiring and connections referring to the following before contacting your dealer.

<u>Symptom</u>	<u>Cause</u>	<u>Action</u>
<ul style="list-style-type: none"> <li>• Belt squeals when engine starts.</li> <li>• Engine output feels weak.</li> <li>• At wide open throttle the boost starts to decrease at a certain RPM while engine RPM is increasing</li> </ul>	Low belt tension	<ul style="list-style-type: none"> <li>• Check the adjustable range of the auto-tensioner. Replace if necessary.</li> </ul>
<ul style="list-style-type: none"> <li>• Engine output feels weak.</li> <li>• At wide open throttle the boost starts to decrease at a certain RPM while engine RPM is increasing</li> </ul>	Worn air filter	<ul style="list-style-type: none"> <li>• Replace the filter element depending on dirt buildup.</li> </ul>

## 15. IF BELT BREAKS

- Park the vehicle in a safe place to check if the car is still drivable. Check for any damage caused by the torn belt such as oil leak, coolant leak, damaged harness, and etc.
- Do not drive the vehicle if the belt is damaged since the water pump is operated by the belt.
- Move the vehicle to a safe place and replace the belt with a brand new one. Repair any problems that may have caused the belt to break.



HKS Co., Ltd.

7181 Kitayama, Fujinomiya, Shizuoka 418-0192, Japan

<http://www.hks-power.co.jp/>