



INSTALLATION MANUAL

Installation must be done by a professional.
 Read this manual prior to the installation.
 Always have access to this manual as well as a factory service manual.

NAME OF PRODUCT	GT2 SUPERCHARGER SYSTEM
PART NUMBER	12001-AN009
APPLICATION	NISSAN Fairlady Z (UA-Z33 • CBA-Z33)
YEAR	2003/07-2006/12
ENGINE	VQ35DE
REMARKS	<p>【NOTE】</p> <ul style="list-style-type: none"> • HKS is not responsible with the damage to the engine and/or other parts of a vehicle after installing this product. • Changing the engine oil to the one with 40 or higher viscosity at high temperatures is recommended.

REVISION OF MANUAL

Rev. Number	Date	Manual Number	Details
3-3.01	2018/05	E04215-N53190-00	1 st Edition

INDEX

NOTICE/ATTENTION	1
PARTS LIST	2
1. BEFORE INSTALLATION	4
2. REMOVAL OF FACTORY PARTS	5
3. MODIFICATION, RELOCATION, and REPLACEMENT OF FACTORY PARTS	7
4. INSTALLATION OF SUPERCHARGER BRACKET	11
5. INSTALLATION OF SUPERCHARGER	14
6. INSTALLATION OF IDLER PULLEY	17
7. INSTALLATION OF INTERCOOLER	19
8. INSTALLATION OF INTERCOOLER PIPE ①	21
9. INSTALLATION OF TRACTION FLUID TANK and FLUID COOLER CORE	23
10. INSTALLATION OF INTERCOOLER PIPE ②	29
11. ADDING TRACTION FLUID	31
12. INSTALLATION OF AIR CLEANER	32
13. INSTALLATION OF BELT	34
14. REINSTALLATION OF FACTORY PARTS	36
15. CONFIRMATION AFTER INSTALLATION	37
16. FIRST MONTH INSPECTION	39
17. MAINTENANCE / MANAGEMENT	40
18. TROUBLESHOOTING	41
19. IF BELT BREAKS	41

NOTICE

This manual assumes that you have and know how to use the tools and equipment necessary to safely perform service operations on your vehicle. This manual assumes that you are familiar with typical automotive systems and basic service and repair procedures. Do not attempt to carry out the operations shown in this manual unless these assumptions are correct. Always have access to a factory repair manual. To avoid injury, follow the safety precautions contained in the factory repair manual.

ATTENTION

- This manual indicates items you need to pay attention to in order to install this product safely and lists precautions to avoid any possible damage and/or accidents.
- This product is an automobile part. Do not use for any other purposes.
- HKS will not be responsible for any damage caused by incorrect installation and/or use, or use after modification and/or dismantling of this product.
- This product was designed based on installation onto a specific factory vehicle.
- The specifications of this product are subject to change without notice.
- The instructions are subject to change without notice. Make sure to refer to the most recent instructions.

SAFETY PRECAUTIONS

The following precautions for use of this product are to prevent possible accidents and/or injuries and for proper use.



WARNING

Indicates risk of serious injury and/or possible death.



CAUTION

Indicates risk of damage to people or large-scale damage to property.
(Large-scale damage is the damage caused by a product defect.
Ex. Damage to a vehicle, burnout, etc.)

PARTS LIST

No.1

No.	Description	QT	No.	Description	QT
1	GT2-7040 Supercharger	1	40	Pipe No.3	1
2	S/C Pulley (φ95)	1	41	Pipe No.4	1
3	Fluid Cooler Core	1	42	Pipe No.5	1
4	Fitting	2	43	Spacer No.4 (φ14-φ6.5-L35)	1
5	Intercooler	1	44	Spacer No.5 (φ14-φ6.5-L18)	2
6	Fluid Tank	1	45	Spacer No.6 (φ10-φ4-t2)	2
7	Traction Fluid	1	46	Gasket	1
8	S/C Bracket No.1	1	47	Hose Assembly φ10 L2500	1
9	S/C Bracket No.2	1	48	Hose 8mm L3000	1
10	Spacer No.1 (φ14-φ6.5-L14.8)	7	49	Hose 16mm L150	1
11	Spacer No.2 (φ12-φ6.5-L57.8)	1	50	Hose 22mm L70	1
12	Spacer No.3 (φ14-φ6.5-L39.8)	1	51	Hose Clamp 13.0mm	4
13	Idler Pulley No.1 (φ108)	1	52	Hose Clamp 15.5mm	3
14	Idler Pulley No.2 (φ115-φ102)	1	53	Hose Clamp 23.0mm	2
15	Bearing Assembly	1	54	Silicone Hose 70mm L55	1
16	Tensioner Pulley (φ84)	1	55	Silicone Hose 80mm-60mm	1
17	Tensioner Spacer	1	56	Silicone Hose 70mm L20	2
18	Tensioner Shaft	1	57	Silicone Hose 60mm L70	2
19	Tensioner Adjuster	1	58	Silicone Hose 60mm-50mm	1
20	Tensioner Bolt	1	59	Silicone Hose 50mm L70	2
21	Belt 6PK 1700	1	60	Hose 4mm L1000	1
22	Belt 7PK 1060	1	61	Hexagon Bolt M8 L20	3
23	Air Cleaner	1	62	Hexagon Bolt M10 L110	1
24	Bracket No.1	1	63	Cap Bolt M4 L12	2
25	Bracket No.2	1	64	Cap Bolt M6 L12	5
26	Bracket No.3	1	65	Cap Bolt M6 L15	10
27	Bracket No.4	1	66	Cap Bolt M6 L18	5
28	Bracket No.5	2	67	Cap Bolt M6 L20	5
29	Bracket No.6	1	68	Cap Bolt M6 L30	1
30	Bracket No.7	1	69	Cap Bolt M6 L40	1
31	Bracket No.8	1	70	Cap Bolt M6 L50	1
32	Bracket No.9	1	71	Cap Bolt M6 L100	3
33	Bracket No.10	1	72	Cap Bolt M8 L12	2
34	Bracket No.11	1	73	Cap Bolt M8 L25	5
35	Bracket No.12	1	74	Cap Bolt M8 L35	3
36	Bracket No.13	2	75	Cap Bolt M12 L120	1
37	Bracket No.14	1	76	Low-head Cap Bolt M6 L12	5
38	Pipe No.1	1	77	Button Bolt M6 L15	2
39	Pipe No.2	1	78	Button Bolt M6 L60	6

PARTS LIST

No.2

No.	Description	QT
79	Hose Band #16	2
80	Hose Band #28	7
81	Hose Band #36	6
82	Hose Band #40	2
83	Hose Band #48	4
84	Flange Nut M6	20
85	Flange Nut M10	1
86	Flat Washer M6 Large Diameter	5
87	Flat Washer M6	30
88	Flat Washer M8	15
89	Flat Washer M10	1
90	Flat Washer M12	1
91	Relief Valve Assembly	1
92	Insulator Rubber	2
93	Joint Pipe 16mm	1
94	Corrugated Tube	1
95	Tie Wrap L	20
96	Tie Wrap M	30
97	Tie Wrap S	30
98	Installation Manual	1
100	Operation Manual	1

※ The number of some bolts, nuts, washers included in this kit are more than required.

1. BEFORE INSTALLATION

Refer to the factory service manual for removal of factory parts.

NOTE

When replacing the fuel pump together, measure the remaining fuel level on a flat surface. If the fuel is full or over 7/8 of the tank, drain the fuel until it marks lower than the level shown in diagram.

NOTE

When the fuel is full, the fuel surface is above the installation surface of the fuel pump; therefore, fuel flows out.

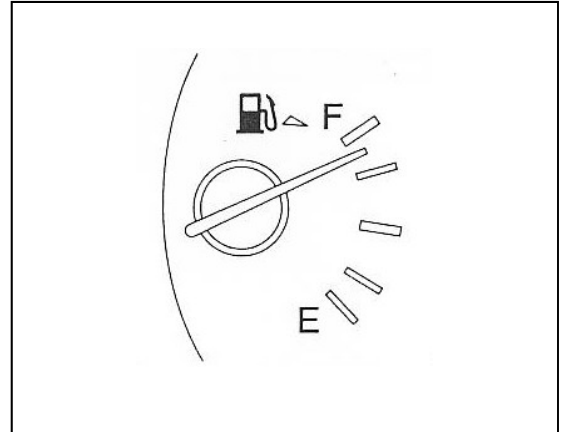

Warning

- When replacing the injectors and fuel pump, follow the factory service manual to eliminate the fuel pressure.
- Gasoline may spatter; it may cause damage to the eyes and vehicle fire.

(1) Disconnect the negative cable from the battery.

2. REMOVAL OF FACTORY PARTS

- (1) Remove the engine under cover.
- (2) Remove the engine cover.
- (3) Remove the ① air duct, ② air cleaner, ③ airflow meter, and ④ air hose.

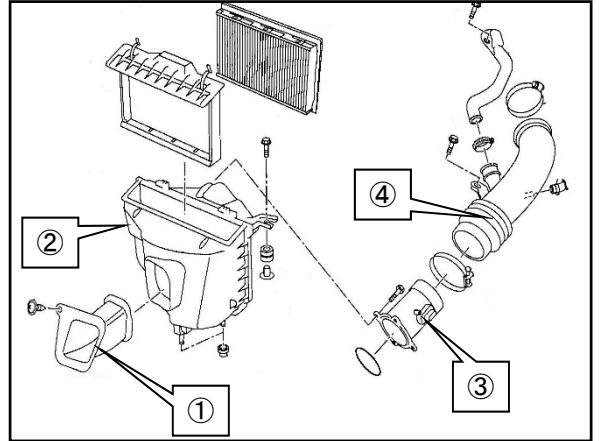

- (4) Remove the following parts from the airflow meter removed in (3): ①Screw, ②Sensor, and ③Rubber seal

NOTE

①Screw, ②Sensor, and ③Rubber seal will be reused later.

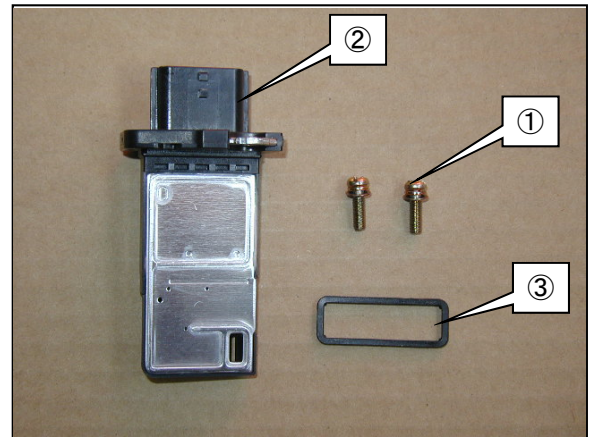

- (5) Remove the bumper.
- (6) Remove ①bumper reinforcement.
- (7) Remove the left side of ②air duct cover.

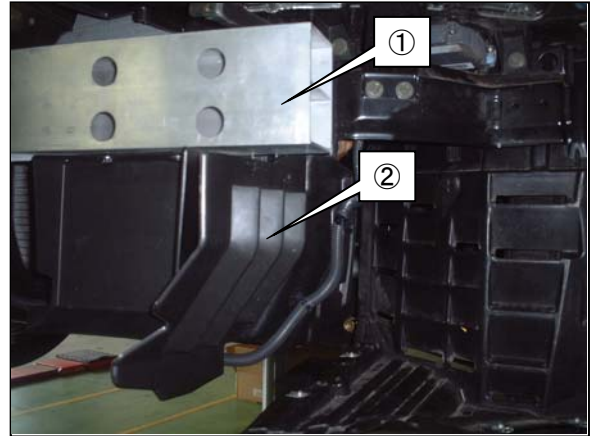

- (8) Remove ①hose clip.

NOTE

①hose clip will be reused later.

- (9) Remove ② harness clamp and ③ harness bracket.

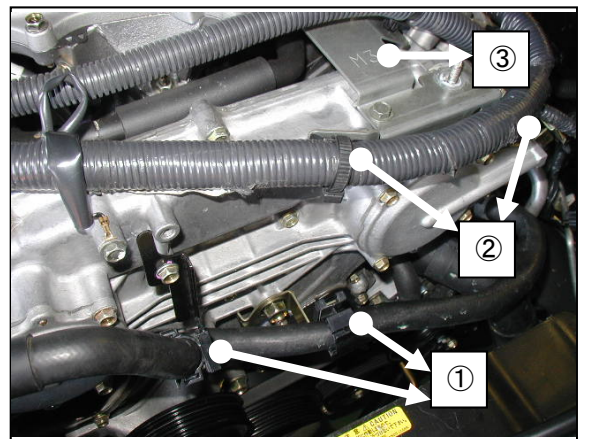

(10) Loosen the four M6 bolts on the ① Idler Pulley.

NOTE

- Loosen these bolts before loosening the power steering pump belt.

(11) Remove the alternator power steering pump belt (6 rib).

(12) Remove ① idler pulley.

(13) Remove two of ② bracket.

(14) Remove ③ water hose clamp.

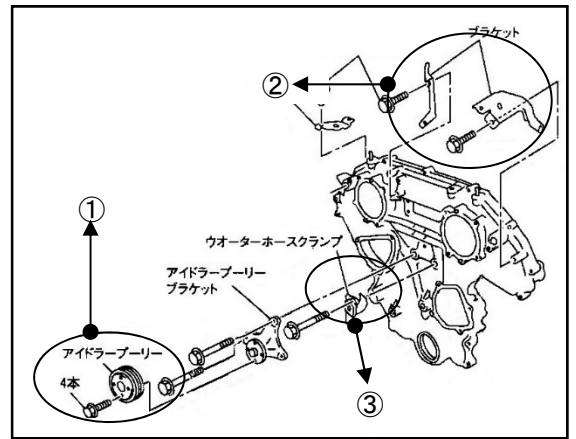

(15) Remove the ① harness clamp .



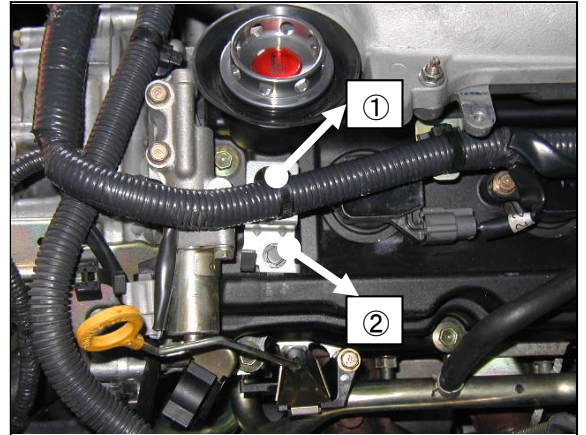

(16) Remove the ② harness bracket.



3. MODIFICATION, RELOCATION, and REPLACEMENT OF FACTORY PARTS

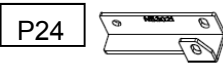
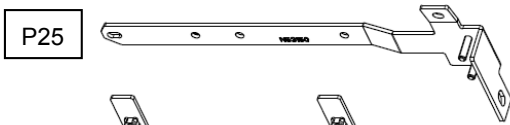
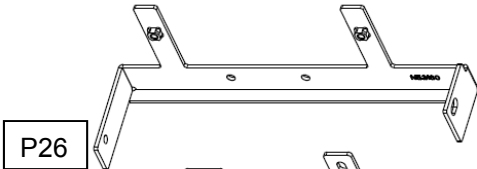
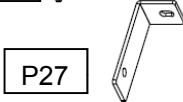

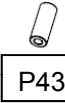
PARTS LIST

		No.	Description	QT.
		P13	Idler Pulley No.1 (φ108)	1
		P24	Bracket No.1	1
		P25	Bracket No.2	1
		P26	Bracket No.3	1
		P27	Bracket No.4	1
		P28	Bracket No.5	1
		P43	Spacer No.4 (φ14 - φ6.5 - L35)	1
		P66	Cap Bolt M6 L18	1
		P70	Cap Bolt M6 L50	1
		P62	Hexagon Bolt M10 L110	1
		P84	Flange Nut M6	2
		P87	Flat Washer M6	2
		P94	Corrugated Tube	1
		P95	Tie Wrap (L)	
		P96	Tie Wrap (M)	
		P97	Tie Wrap (S)	

(1) Remove both horns.

NOTE

- Check the mark of position of + and – in the Coupler. If the connection is wrong, it may result in blowing the horn fuse.

(2) Change the direction of ①Bracket and ②Terminal.

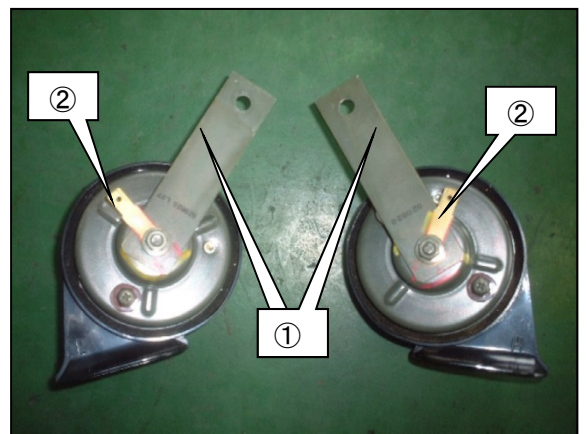

(3) Install BracketNo.1 on the position of the left horn.

- Bracket No.1(P24×1)
- Stock Bolt (Reuse)

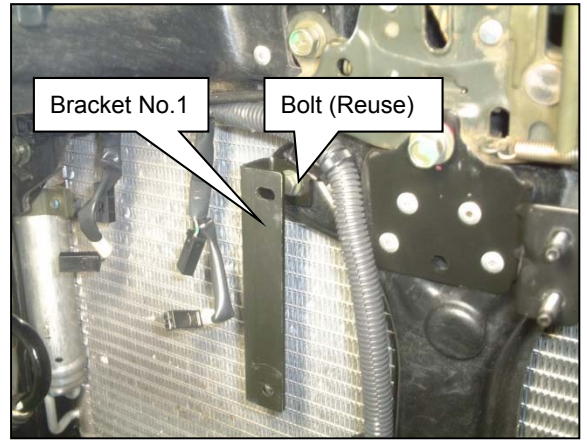

(4) Install the horn to Bracket No.2.

- Bracket No.2 (P25)
- Spacer No.4 (φ14 - φ6.5 - L35) (P43)
- Cap Bolt M6 L=50 (P70)
- Flange Nut M6 (P84)
- Flat Washer M6 (P87)
- Stock Bolt (Reuse)

(5) Install Bracket No.2 to the vehicle.

- Stock Bolt (Reuse)

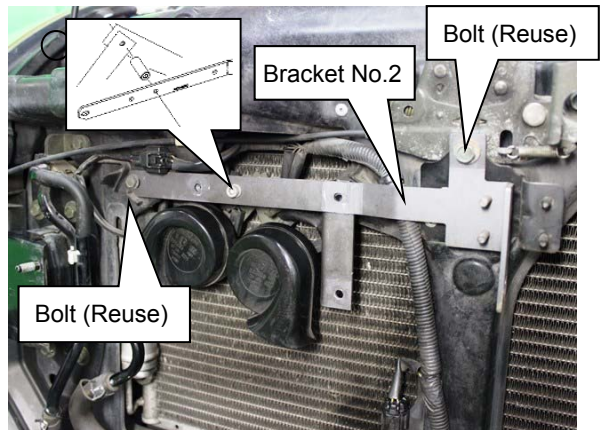

(6) Install Bracket No.5 to Bracket No.2.

- Bracket No.5 (P28)
- Cap Bolt M6 L18 (P66)
- Flange Nut M6 (P84)
- Flat Washer M6 (P87)

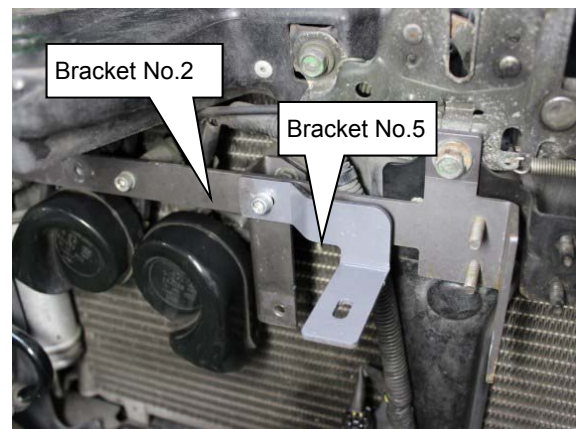

(7) Replace a stock bolt of ①power steering pump bracket to Hexagon Bolt M10 L110.

- Hexagon Bolt M10 L110 (P62)

Tightening Torque N·m(kgf·m) T=53.9(5.5)

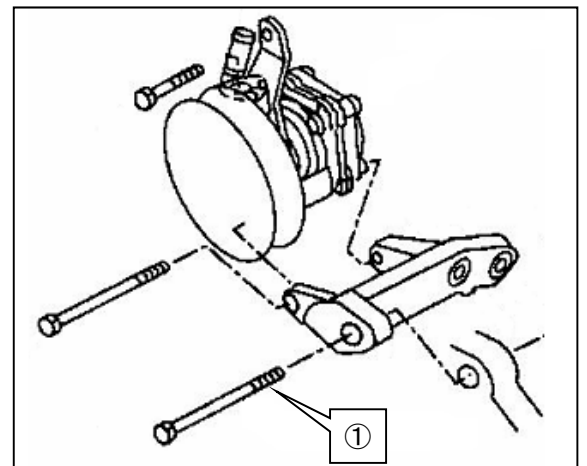

(8) Temporarily install the Idler Pulley No.1 to the idler pulley bracket where the stock idler pulley was removed in 2. (12).

- Idler Pulley No.1 (φ108) (P13)
- Stock Bolt

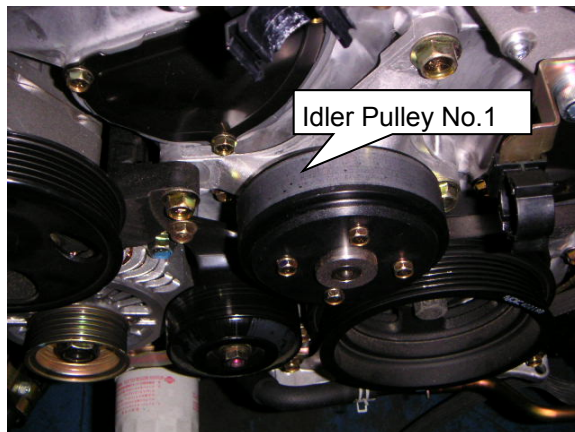

(9) Install the Bracket No.3 and No.4; then relocate the power steering fluid cooler

- Bracket No.3 (P26)
- Bracket No.4 (P27)

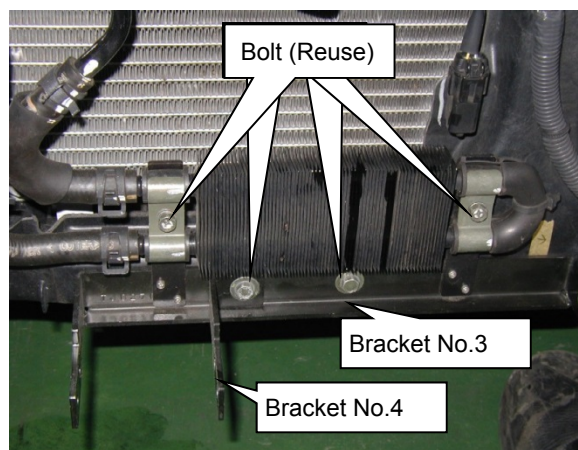

(10) Remove ② harness cover from ① harness.

(11) Remove ③ coupler securing to the vehicle from the vehicle.

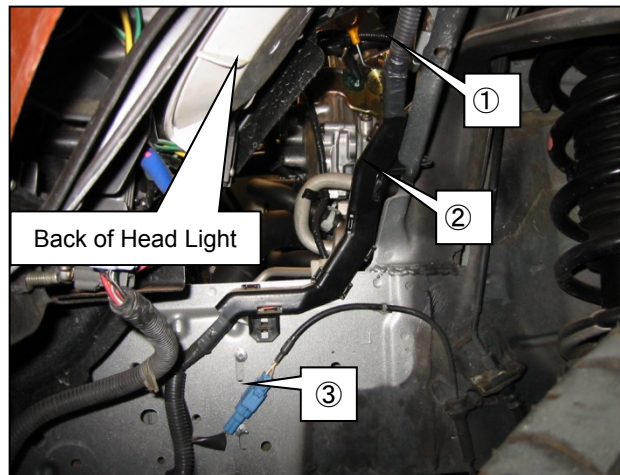
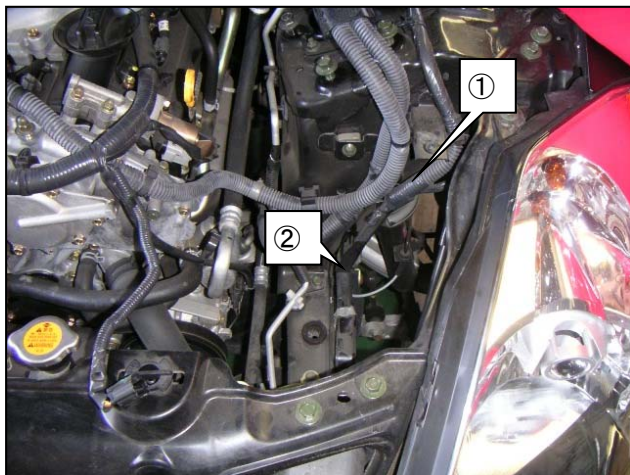

(12) Cover ①stock harness with the Corrugated Tube, and secure the covered harness to the panel underneath of the left side head light.

- Corrugated Tube (P94)
- Tie Wrap (L) (P95)
- Tie Wrap (M) (P96)
- Tie Wrap (S) (P97)

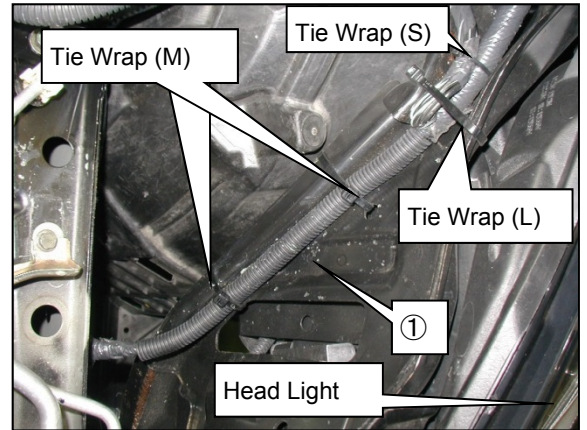

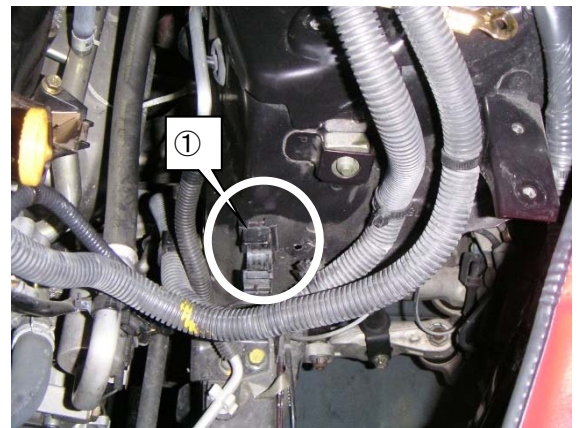

(13) Remove the clip from ①stock harness.



4. INSTALLATION OF SUPERCHARGER BRACKET

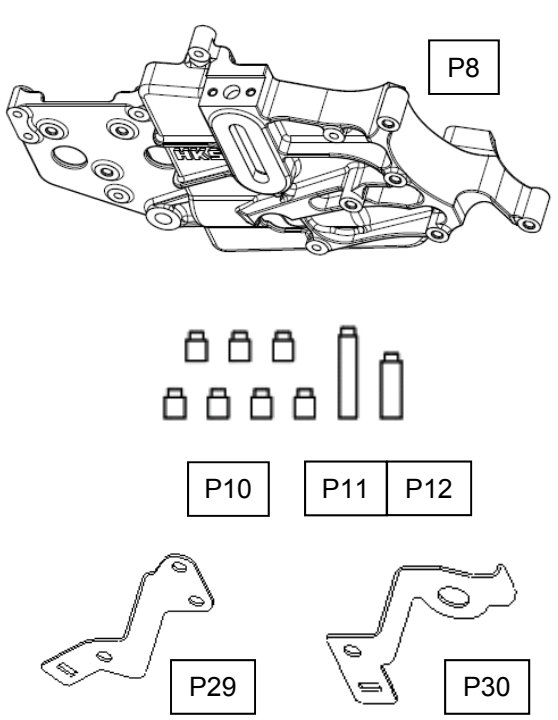

PARTS LIST			
	No.	Description	QT
 	P8	S/C Bracket No.1	1
	P10	Spacer No.1 (φ14 - φ6.5 - L14.8)	7
	P11	Spacer No.2 (φ12 - φ6.5 - L57.8)	1
	P12	Spacer No.3 (φ14 - φ6.5 - L39.8)	1
	P16	Tensioner Pulley (φ84)	1
	P17	Tensioner Spacer	1
	P18	Tensioner Shaft	1
	P19	Tensioner Adjuster	1
	P20	Tensioner Bolt	1
	P29	Bracket No.6	1
	P30	Bracket No.7	1
	P71	Cap Bolt M6 L100	3
	P75	Cap Bolt M12 L120	1
	P77	Button Bolt M6 L15	2
	P78	Button Bolt M6 L60	6
	P85	Flange Nut M10	1
	P87	Flat Washer M6	9
	P89	Flat Washer M10	1
	P90	Flat Washer M12	1

(1) Press-fit Spacer No.1, No.2, and No.3 to S/C Bracket No.1.

- S/C Bracket No.1 (P8)
- Spacer No.1 ($\phi 14 - \phi 6.5 - L14.8$) (P10 \times 7)
- Spacer No.2 ($\phi 12 - \phi 6.5 - L57.8$) (P11)
- Spacer No.3 ($\phi 14 - \phi 6.5 - L39.8$) (P12)

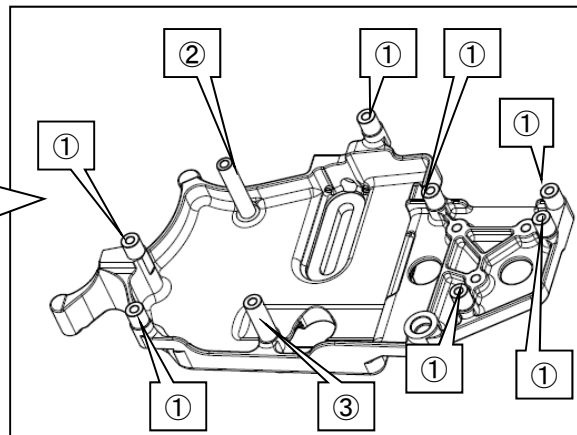
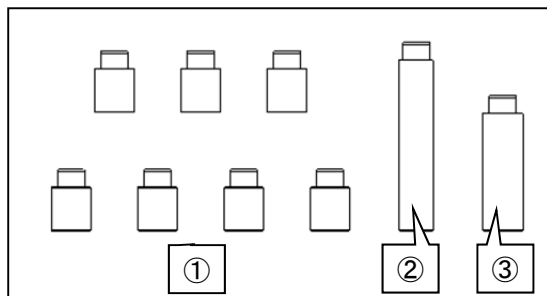

(2) Install ①Tensioner Shaft, ②Tensioner Bolt, and ③ Tensioner Adjuster.

- Tensioner Shaft (P18)
- Tensioner Adjuster (P19)
- Tensioner Bolt (P20)
- Button Bolt M6 L15 (P77 \times 2)

(3) Temporarily install ④ Tensioner Spacer and ⑤ Tensioner Pulley to ①Tensioner Shaft.

- Tensioner Pulley ($\phi 84$) (P16)
- Tensioner Spacer (P17)
- Flange Nut M10 (P85)
- Flat Washer M10 (P89)

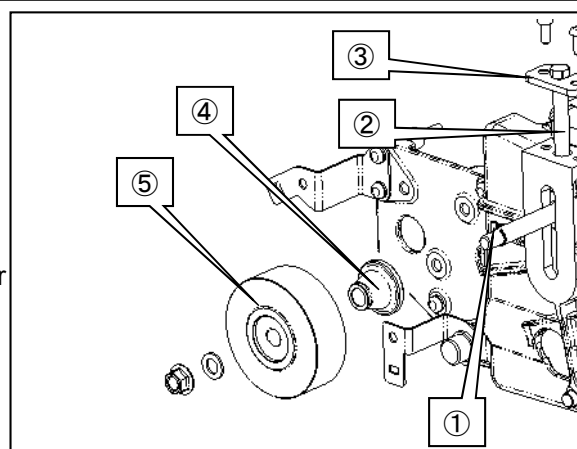

(4) Remove 10 stock bolts indicated by arrows in the diagram.

NOTE

- For 35th Anniversary Model and models with manual transmissions registered after November, remove these bolts as well.

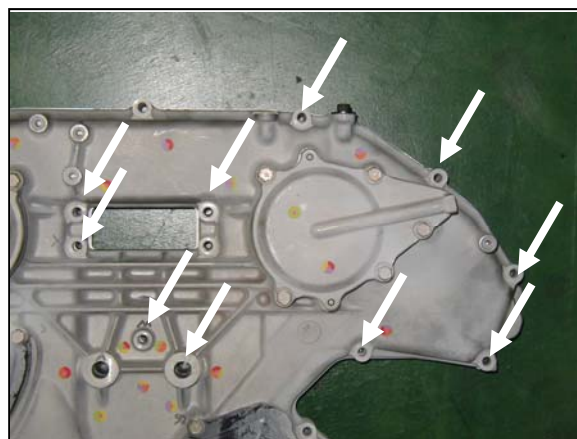

(5) Install the S/C Bracket No.1 to the engine. When installing this bracket, make sure to tighten ① bolt with the Bracket No.6 and ④ bolt with Bracket No.7.

- Bracket No.6 (P29)
- Bracket No.7 (P30)
- Cap Bolt M6 L100 (P71×3)
- Cap Bolt M12 L120 (P75)
- Button Bolt M6 L60 (P78×6)
- Flat Washer M6 (P87×9)
- Flat Washer M12 (P90)

(①・②): Button Bolt M6 L60 & Flat Washer M6)

Tightening Torque N·m(kgf·m)

T=11.7~13.7(1.2~1.4)

(③): Cap Bolt M6 L100 & Flat Washer M6)

Tightening Torque N·m(kgf·m)

T=11.7~13.7(1.2~1.4)

(④): Cap Bolt M12 L120 & Flat Washer M12)

Tightening Torque N·m(kgf·m)

T=68.6~79.4(7.0~8.1)

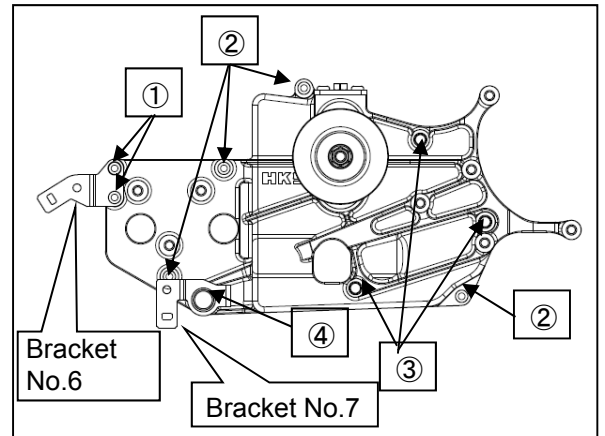

5. INSTALLATION OF SUPERCHARGER

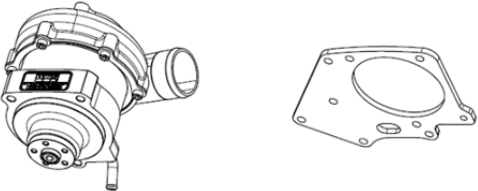
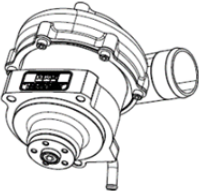
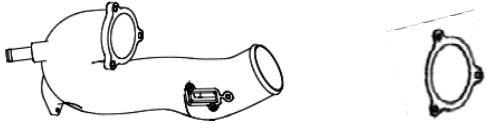
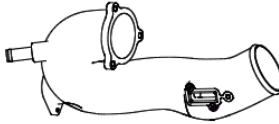
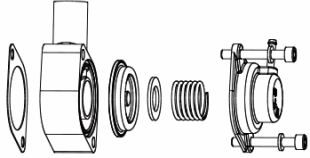
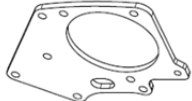

PARTS LIST

		No.	Description	QT
		P1	GT2-7040	1
		P9	S/C Bracket No.2	1
		P38	Pipe No.1	1
		P46	Gasket	1
		P45	Spacer No.6 (φ10 - φ4 - t2)	2
		P48	Hose 8mm L3000	1
		P49	Hose 16mm L150	1
		P50	Hose 22mm L70	1
		P51	Hose Clamp 13.0mm	1
		P53	Hose Clamp 23.0mm	2
		P63	Cap Bolt M4 L12	2
		P67	Cap Bolt M6 L20	3
		P73	Cap Bolt M8 L25	5
		P74	Cap Bolt M8 L35	3
		P79	Hose Band #16	1
		P87	Flat Washer M6	3
		P88	Flat Washer M8	8
P91	Relief Valve Assembly	1		
P93	Joint Pipe φ16	1		

(1) Install ⑦Hose 22mm to ②lower body by inserting the hose until it reaches to the end.

- Relief Valve Assembly (P91)
- Hose 22mm L70 (P50)
- Hose Band #16 (P79)

(2) Install the following parts to ⑧pipe in the order of ①gasket, ②lower body, ③diaphragm, ④shim, ⑤spring, and ⑥ upper body

- Relief Valve Assembly (P91)
 - Gasket
 - Lower Body
 - Diaphragm
 - Shim
 - Spring
 - Bolt M6 L45
 - Flat Washer M6

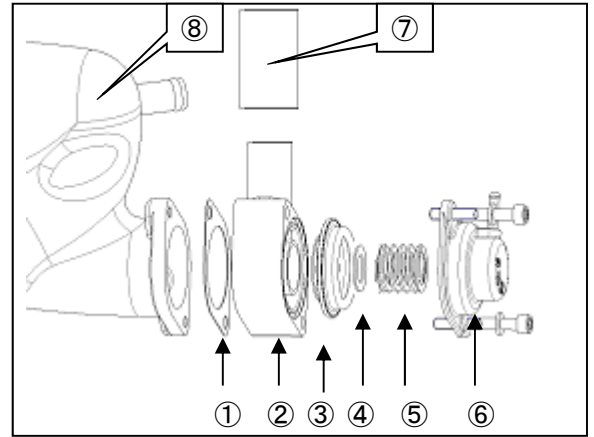

NOTE

- Shim is pertinent to proper relief operation; make sure to install the shim here.

(3) Reinstall ①stock airflow sensor removed in 2 (4) to ③ Pipe No.1 inserting ②Spacer No.6 ($\phi 10-\phi 4-t2$) between the sensor and pipe.

- Pipe No.1 (P38)
- Spacer No.6 ($\phi 10-\phi 4-t2$) (P45 \times 2)
- Cap Bolt M4 L12 (P63 \times 2)
- Stock airflow sensor

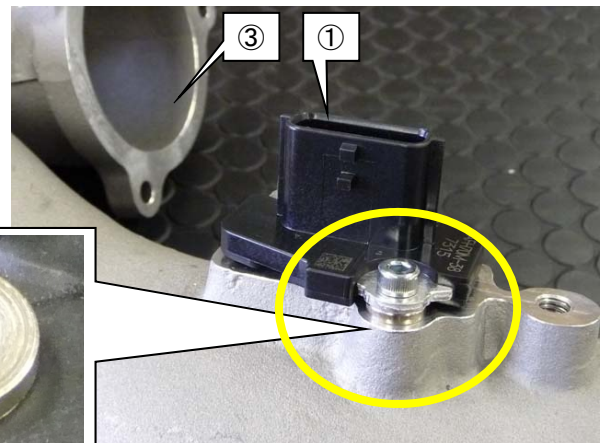
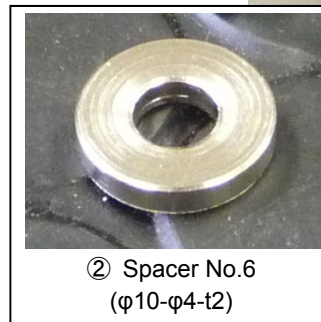

(4) Install ①Pipe No.1 to ②GT2-7040.

- GT2-7040 (P1)
- Cap Bolt M6 L20 (P67 \times 3)
- Flat Washer M6 (P87 \times 3)
- Gasket (P46)

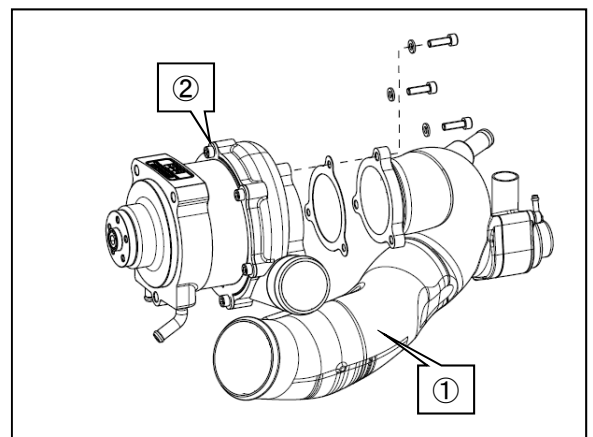

- (5) Place the GT2-7040 on the S/C Bracket No.1 so as to the bracket comes in between the airflow sensor and supercharger.



- (6) Connect ①airflow sensor connector.
- (7) Cut the Hose 8mm L=3000 to 2230mm in length.
(The remained hose will be used in 9 (9).)
- Hose 8mm L3000 (P48)
- (8) Connect 2230mm long Hose 8mm to the GT2-7040.
(② in Diagram)
- Hose Clamp 13.0mm (P51)
- (9) Cap the end of Hose 8mm to prevent foreign object entry.

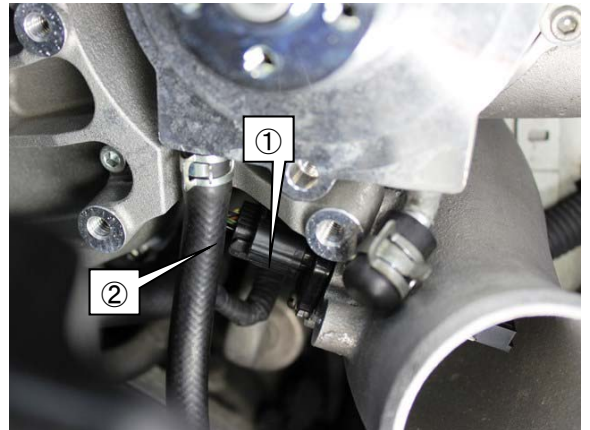

- (10) Install the GT2-7040 to the S/C Bracket No.1.

- S/C Bracket No.2 (P9)
- Cap Bolt M8 L25 (P73×5)
- Cap Bolt M8 L35 (P74×3)
- Flat Washer M8 (P88×8)

Tightening Torque N·m(kgf·m)

- ① (Cap Bolt M8 L25): T=19.6 - 24.5 (2.0~2.2)
- ② (Cap Bolt M8 L35): T=29 (3.0)

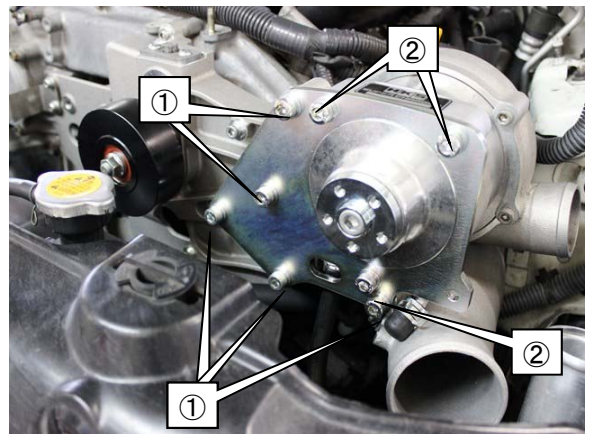

- (11) Connect ①Pipe No.1 and ②stock blow-by return hose.

- Hose Clamp 23.0mm (P53×2)
- Joint Pipe 16mm (P93)
- Hose 16mm L150 (P49)

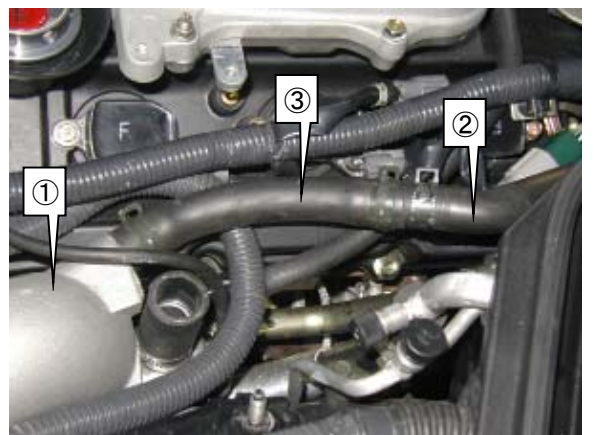

6. INSTALLATION OF IDLER PULLEY

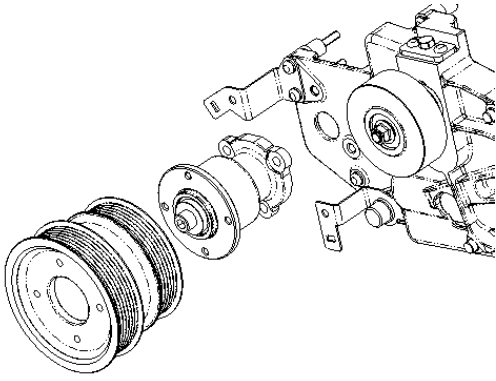

PARTS LIST

No.	Description	QT
P14	Idler Pulley No.2 (φ115-φ102)	1
P15	Bearing Assembly	1
P21	Belt 6PK 1700	1
P31	Bracket No.8	1
P61	Hexagon Bolt M8 L20	3
P64	Cap Bolt M6 L12	2
P66	Cap Bolt M6 L18	4
P84	Flange Nut M6	2
P87	Flat Washer M6	6
P88	Flat Washer M8	3



P31

(1) Cover ① Bearing Assembly with ② Idler Pulley No.2, and install the Bearing Assembly to ③ S/C Bracket No.1.

- Idler Pulley No.2 (φ115-φ102) (P14)
- Bearing Assembly (P15)
- Hexagon Bolt M8 L20 (P61×3)
- Flat Washer M8 (P88×3)

Tightening Torque N·m(kgf·m)

T=19.6~24.5(2.0~2.2)

NOTE

- Idler Pulley No.2 cannot be installed after installing the Bearing Assembly.

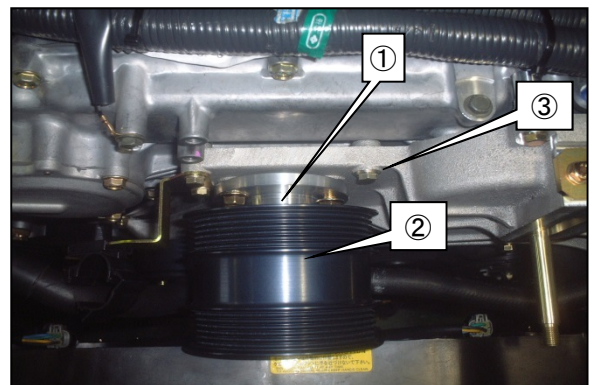

- (2) Install the ②Idler Pulley No.2 to the ①Bearing Assy.
When tightening the M6 Cap Bolt L=18, set an 8mm hex wrench on the M10 Cap Bolt (② in the diagram) to apply torque.

- Cap Bolt M6 L=18 (P66×4)
- Flat Washer M6 (P87×4)

Tightening Torque N·m(kgf·m)

T=11.7~13.7(1.2~1.4)

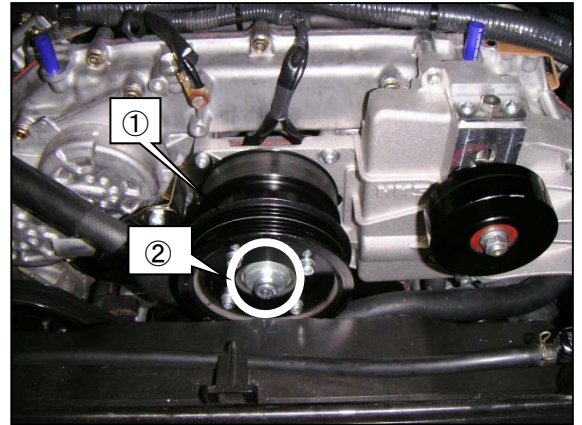

CAUTION

- Make sure to completely tighten the Cap Bolt M6 L=18 at this point. If tightened after installing the Belt 6PK1700, the tightening torque may become improper so the Cap Bolt may become damaged, and the Idler Pulley No. 2 may slip off during driving.
- Use a torque wrench to tighten these bolts. The bolts may become damaged if tightened with insufficient or excessive torque, and the Idler Pulley No. 2 may slip off during driving.

- (3) Install ①Belt 6PK 1700 to the Idler Pulley No.2.

- Belt 6PK 1700 (P21)

- (4) Install ②water hose clip to ③Bracket No.6 and ④ Bracket No.7; then secure the water hose with the clip.

NOTE

- The Belt 6PK 1700 cannot be installed on the Idler Pulley No.2 after securing the water hose.

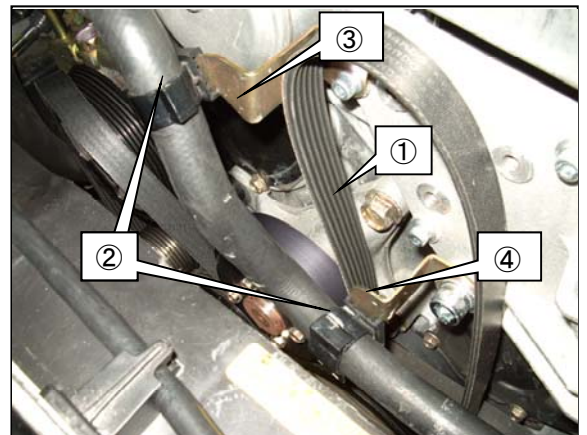

- (5) Install ①Bracket No.8.

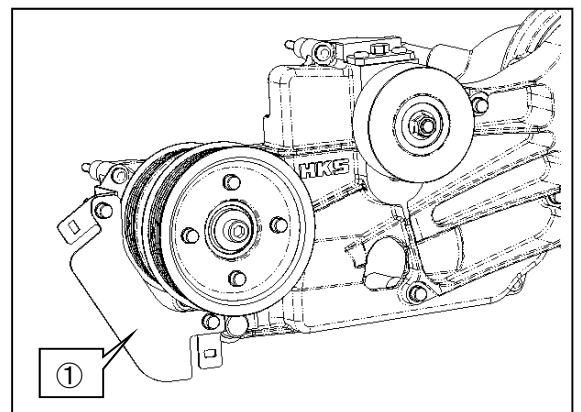

- Bracket No.8 (P31)
- Cap Bolt M6 L12 (P64×2)
- Flange Nut M6 (P84×2)
- Flat Washer M6 (P87×2)

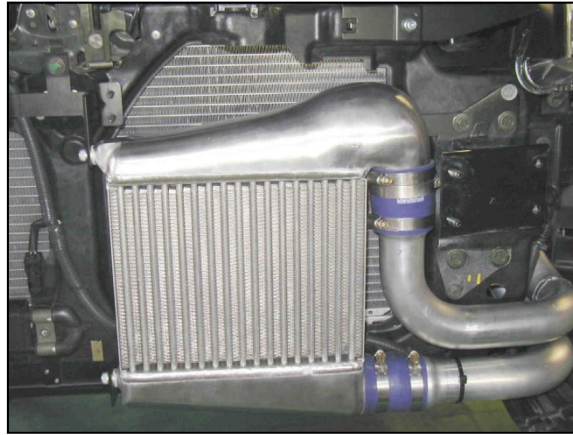

7. INSTALLATION OF INTERCOOLER



PARTS LIST

		No.	Description	QT
		P5	Intercooler	1
		P32	Bracket No.9	1
		P33	Bracket No.10	1
		P57	Silicone Hose 60mm L70	1
		P65	Cap Bolt M6 L15	1
		P72	Cap Bolt M8 L12	2
		P81	Hose Band #36	1
		P82	Hose Band #40	1
		P84	Flange Nut M6	1
		P87	Flat Washer M6	1
		P88	Flat Washer M8	2

(1) Install ①Silicone Hose 60mm to ②Intercooler.

- Intercooler (P5)
- Silicone Hose 60mm L70 (P57)
- Hose Band #36 (P81)

(2) Temporarily install ③Bracket No.9 to the Intercooler.

- Bracket No.9 (P32)
- Hose Band #40 (P82)

NOTE

- Make sure the hose band is not placed over the bead of the intercooler pipe.

(3) Temporarily install ④Bracket No.10 to ③Bracket No.9.

- Bracket No.10 (P31)
- Cap Bolt M6 L15 (P65)
- Flange Nut M6 (P84)
- Flat Washer M6 (P87)



(4) Install the Intercooler.



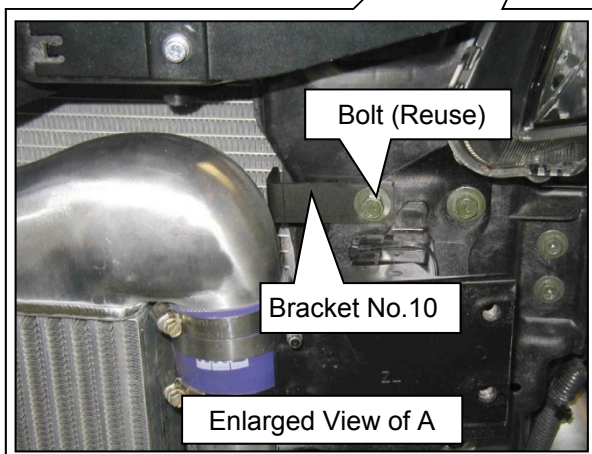
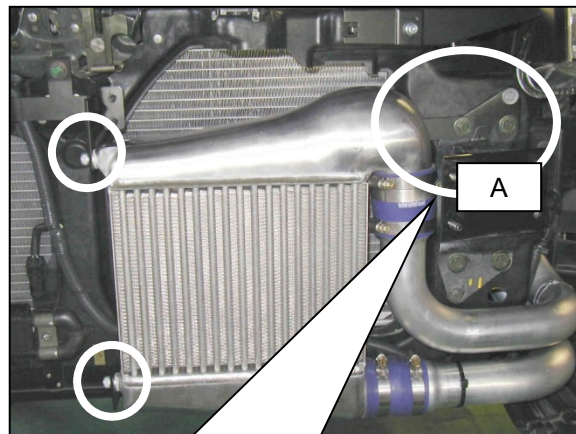

- Make sure the Bracket No.9 and 10 do not come in contact with the intercooler and bumper reinforcement before completely tighten the bolts.
- Cap Bolt M8 L12 (P72×2)
- Flat Washer M8 (P88×2)

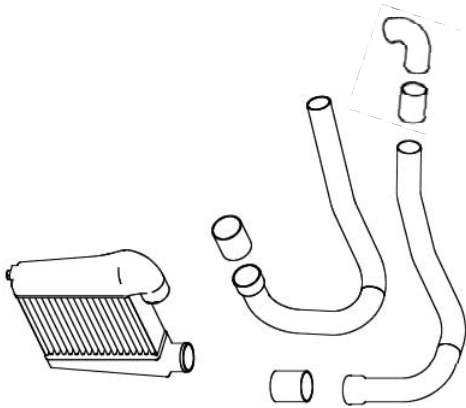

8. INSTALLATION OF INTERCOOLER PIPE①

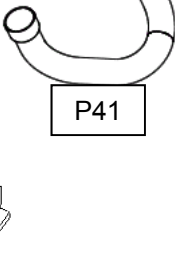
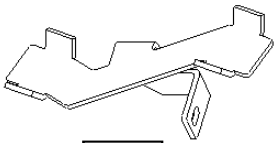
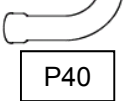

PARTS LIST

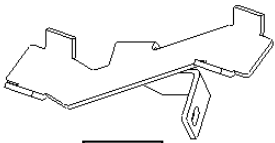
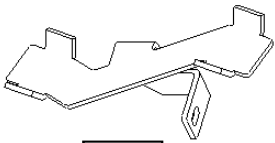
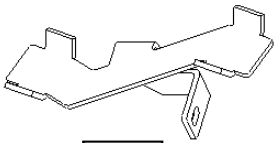
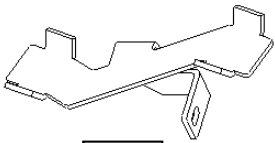
	No.	Description	QT
	P34	Bracket No.11	1
	P39	Pipe No.2	1
	P40	Pipe No.3	1
	P41	Pipe No.4	1
	P57	Silicone Hose 60mm L70	1
	P59	Silicone Hose 50mm L70	2
	P80	Hose Band #28	6
	P81	Hose Band #36	3
	P92	Insulator Rubber	2
	P96	Tie Wrap (M)	
	P97	Tie Wrap (S)	

(1) Install the Pipe No.3 and No.4 to the Intercooler. Secure these pipes using the Bracket No.11 and other provided parts.

- Bracket No.11 (P34)
- Pipe No.3 (P40)
- Pipe No.4 (P41)
- Silicone Hose 60mm L70 (P57)
- Hose Band #28 (P80×2)
- Hose Band #36 (P81×3)
- Insulator Rubber (P92×2)

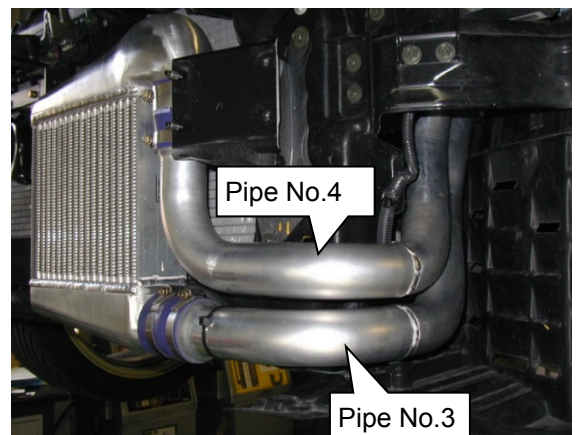

(2) Secure ①stock coupler to the Bracket No.11 using the following parts

- Tie Wrap (M) (P96)
- Tie Wrap (S) (P97)
- Stock Bolt

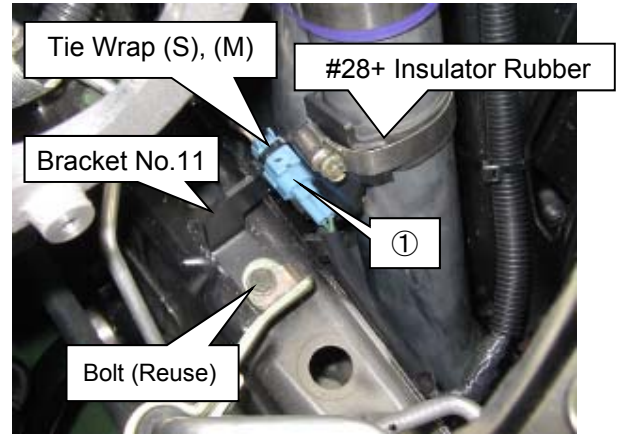

(3) Connect GT2-7040 with the Pipe No.3 using the Pipe No.2. When installing the pipe, cut ①Silicone Hose 50mm L70 to 60mm in length.

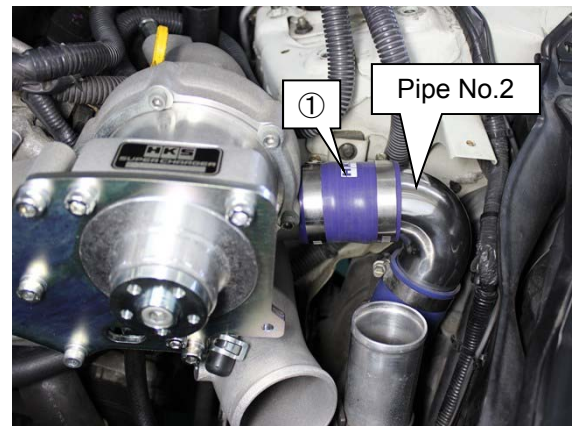

- Pipe No.2 (P39)
- Silicone Hose 50mm L70 (P59×2)
- Hose Band #28 (P80×4)

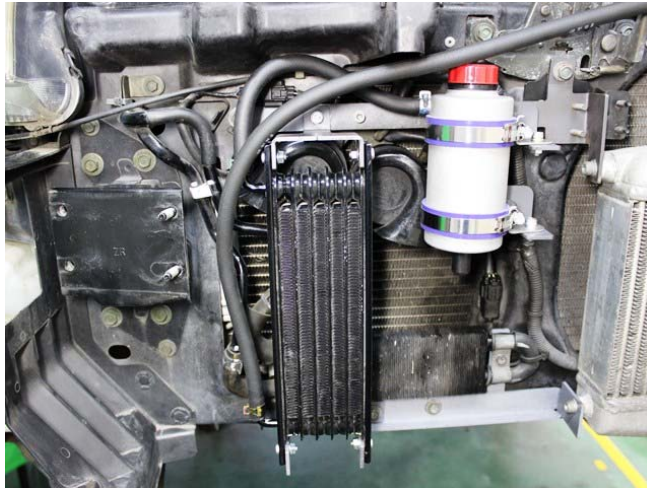

9. INSTALLATION OF TRACTION FLUID TANK and FLUID COOLER CORE

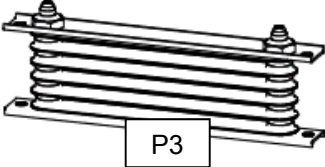
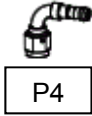
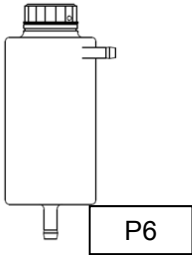
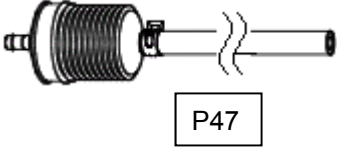
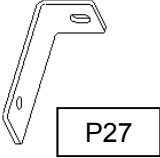
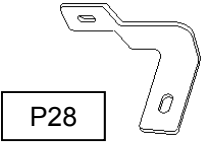
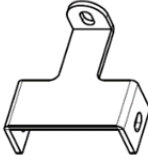

PARTS LIST

		No.	Description	QT
		P3	Fluid Cooler Core	1
		P4	Fitting	1
		P6	Fluid Tank	1
		P27	Bracket No.4	1
		P28	Bracket No.5	1
		P35	Bracket No.12	1
		P36	Bracket No.13	2
		P47	Hose Assembly φ10 L2500	1
		P48	Hose 8mm L3000	1
		P51	Hose Clamp 13.0mm	3
		P52	Hose Clamp 15.5mm	2
		P56	Silicone Hose 70mm L20	2
		P65	Cap Bolt M6 L15	8
		P84	Flange Nut M6	8
		P86	Flat Washer M6 Large Diameter	4
		P87	Flat Washer M6	4
		P83	Hose Band #48	2
		P95	Tie Wrap (L)	
		P96	Tie Wrap (M)	
		P97	Tie Wrap (S)	

NOTE

- Make sure to prevent foreign objects entry to the traction fluid. Failure to do so may cause damage to the supercharger.
- Cover the hose(s) and fitting(s) openings while installing to prevent foreign objects entry.

○Reference the diagram below for the correct piping procedures to follow.

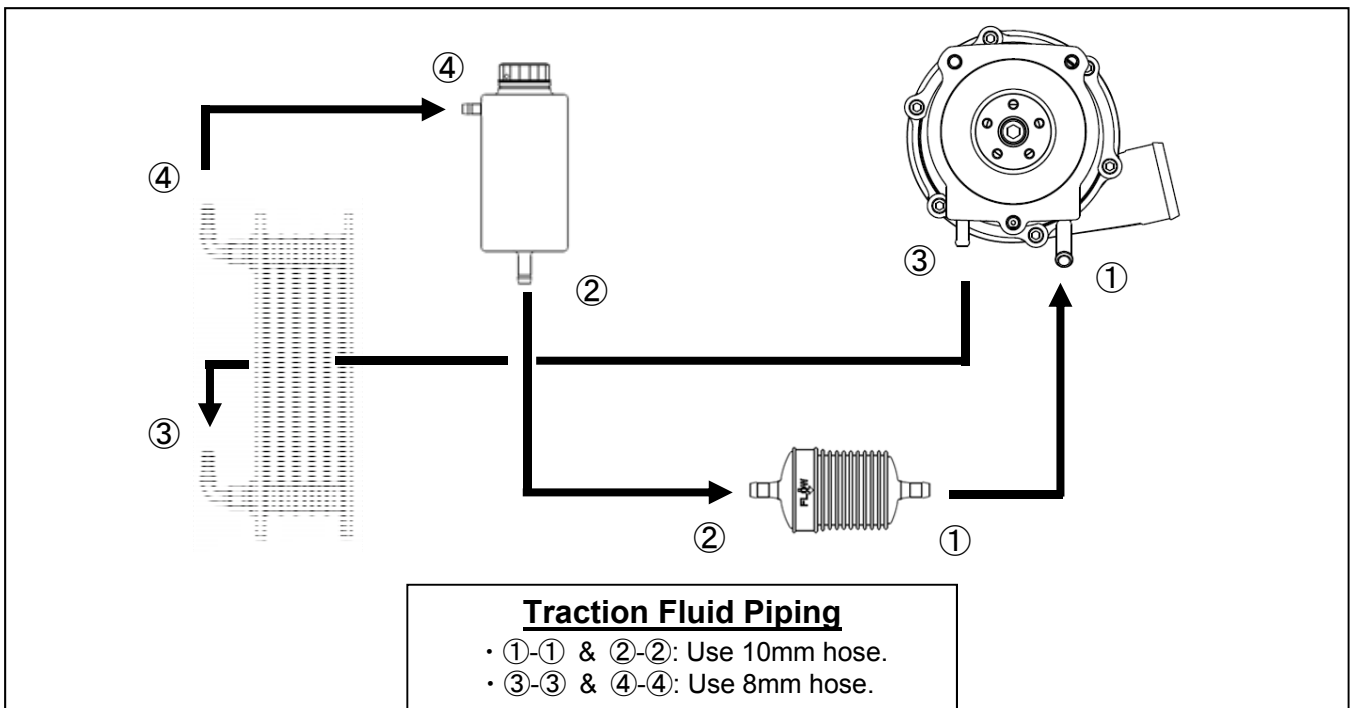

(1) Make sure there are no debris/foreign objects in ①Fluid Tank.

(2) Install ②Bracket No.13 to ①Fluid Tank.

- Bracket No.13 (P36×2)
- Hose Band #48 (P83×2)
- Silicone Hose 70mm L20 (P56×2)

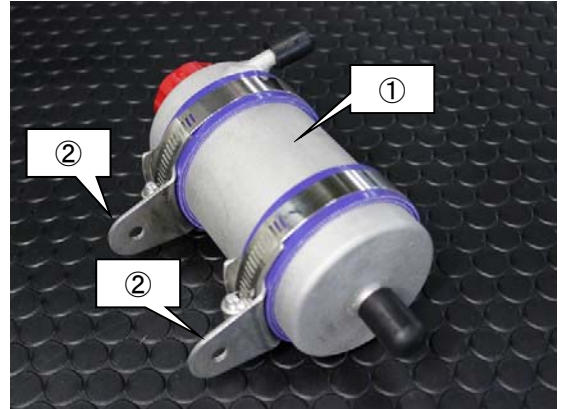

(3) Install ②Bracket No.5 to ①Bracket No.1.

- Bracket No.5 (P28)
- Cap Bolt M6 L15 (P65)
- Flange Nut M6 (P84)
- Flat Washer M6 (P87)

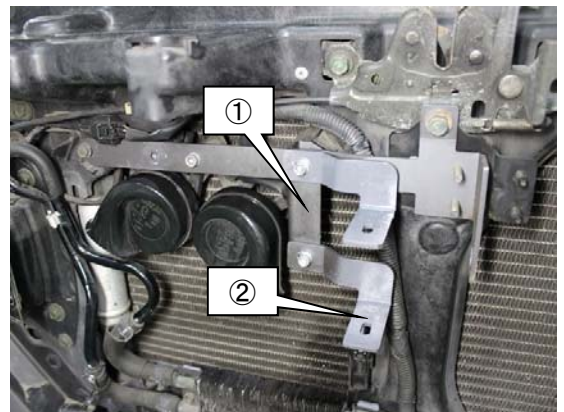

(4) Install ①Fluid Tank to ②Bracket No.5.

- Cap Bolt M6 L15 (P65×2)
- Flange Nut M6 (P84×2)
- Flat Washer M6 (P87×2)

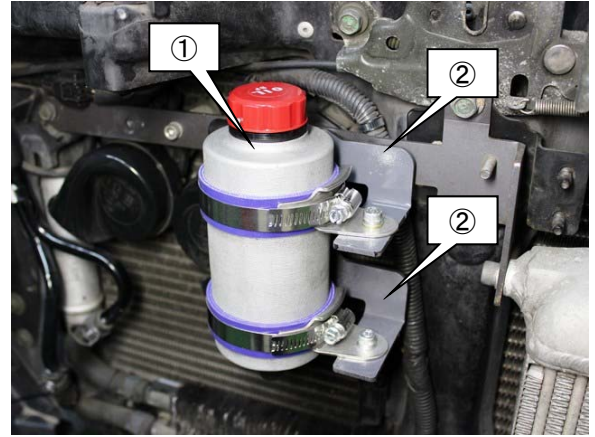

(5) Install ①Bracket No.12 to ②Fluid Cooler Core.

- Bracket No.12 (P35)
- Cap Bolt M6 L15 (P65×2)
- Flange Nut M6 (P84×2)
- Flat Washer M6 Large Diameter (P86×2)

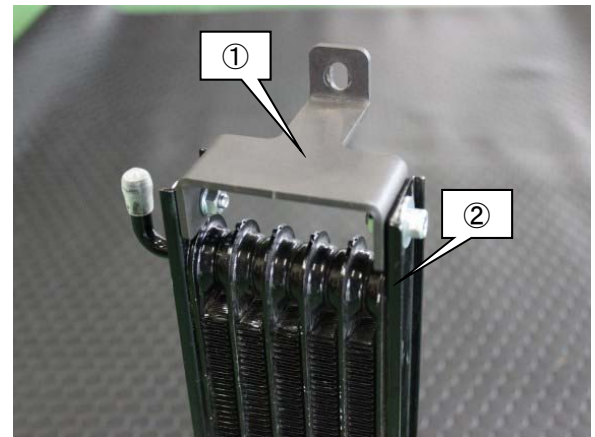

(6) Loosen ①bolt securing Bracket No.4.

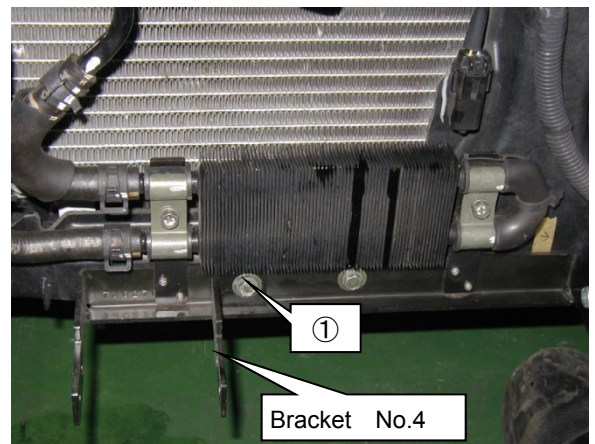

(7) Install ①Fluid Tank to the vehicle.

- Cap Bolt M6 L15 (P65×3)
- Flange Nut M6 (P84×3)
- Flat Washer M6 Large Diameter (P86×2)
- Flat Washer M6 (P87)

(8) Tighten the bolt loosened in (6).

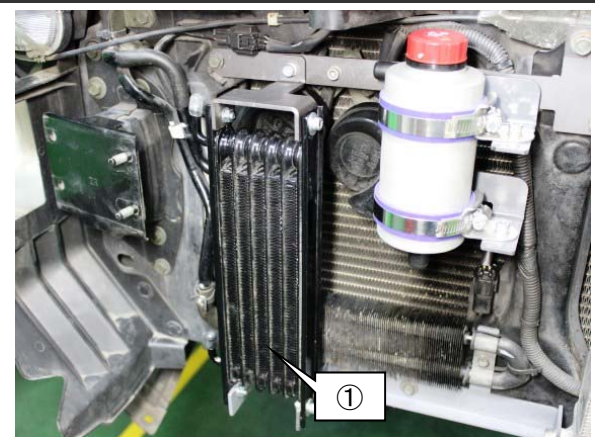

(9) Cut the remained Hose 8mm L3000 to 250mm in length.

- Hose 8mm L3000 (P48)

(10) Cut ①Hose Assembly ϕ 10 L2500 of the oil filter side into 1210mm.

- Hose Assembly ϕ 10 L2500 (P47)

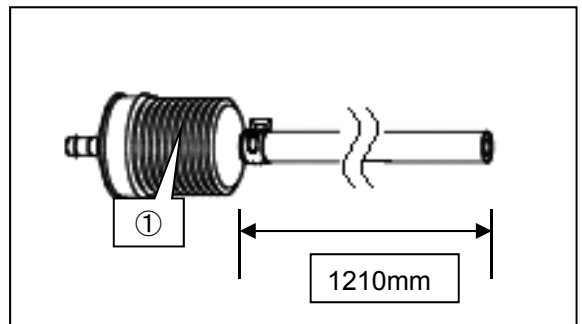

(11) Route the Hose 8mm connected to GT2-7040 over the side member through the underneath the head light to the front side of the radiator.

(12) Route the Hose Assembly ϕ 10 cut in (10) from the front side of the radiator through the underneath the head light to the above of the side member.

(13) Temporarily connect the Hose Assembly ϕ 10 cut to 1210mm in (10) to GT2-7040.

※ Hose Clamp 15.5mm (P52) will be used later.

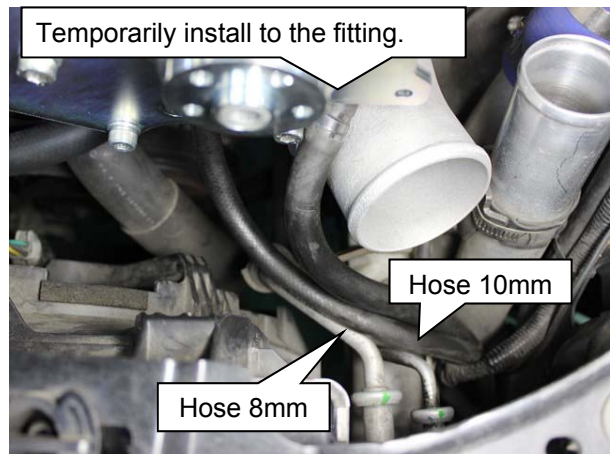
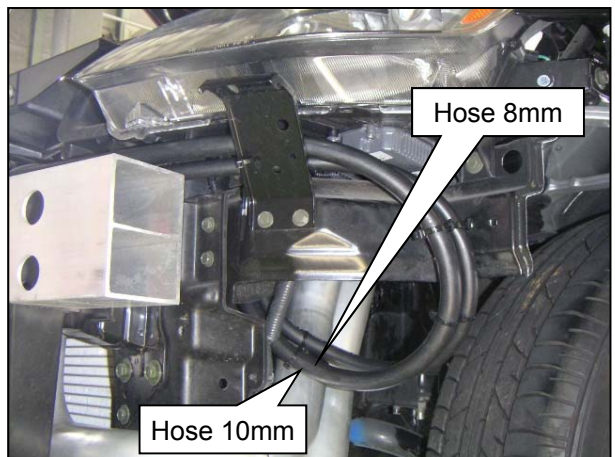

(14) Connect ①fitting of the fluid cooler core's upper side and fluid tank using the Hose 8mm cut to 250mm in (9).

- Fitting (P4)
- Hose Clamp 13.0mm (P51×2)

(15) Connect the Hose 8mm from GT2-7040 to ②fitting of the fluid cooler core's lower side using the provided Fitting.

- Fitting (P4)
- Hose Clamp 13.0mm (P51)

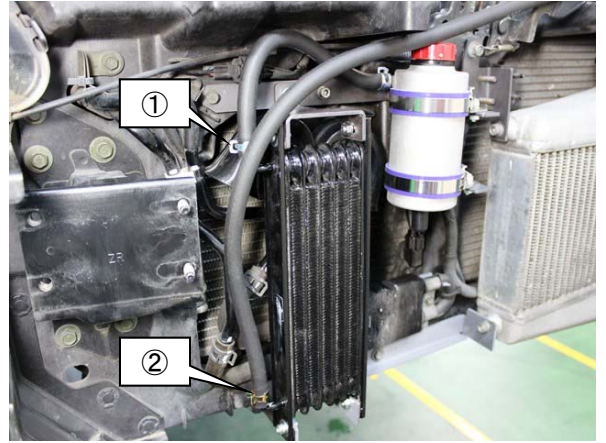

(16) Secure ①Hose 8mm to the power steering fluid pipe.

- Tie Wrap (M) (P96)
- Tie Wrap (S) (P97)

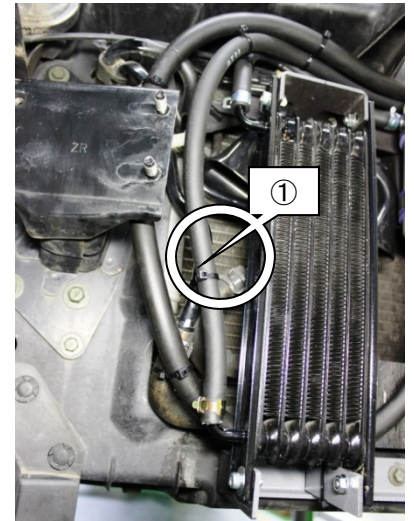

(17) Cut the remained Hose Assembly 10mm to 1250mm. Connect the fluid filter and ①Fluid Tank using the 1250mm long Hose Assembly 10mm. Make sure to route the Hose Assembly 10mm behind the back of the core, and secure to ②power steering fluid pipe and ③Bracket No.4 using Tie Wraps.

- Hose Clamp 15.5mm (P52×2)
- Tie Wrap (M) (P96)
- Tie Wrap (S) (P97)

※ The diagram shows how the hose is connected without the fluid cooler core.

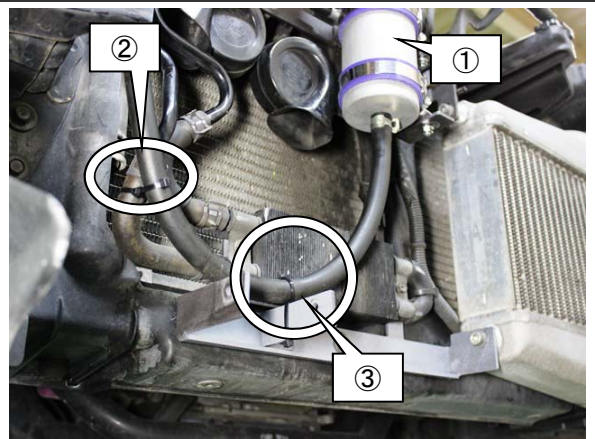

(18) Reinstall the bumper reinforcement.

(19) Secure the Hose 8mm, Hose 10mm, and fluid filter to the vehicle.

- Tie Wrap (L) (P95)
- Tie Wrap (M) (P96)
- Tie Wrap (S) (P97)

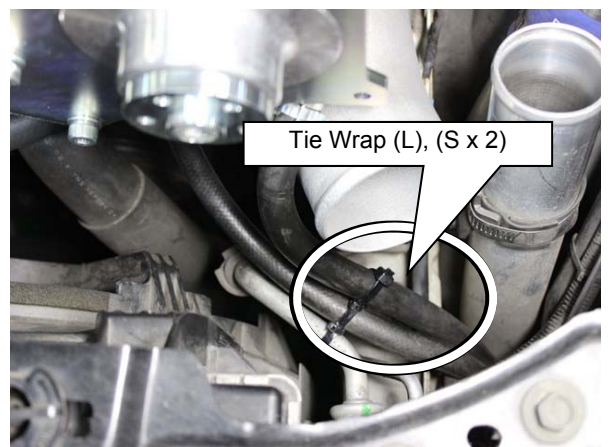
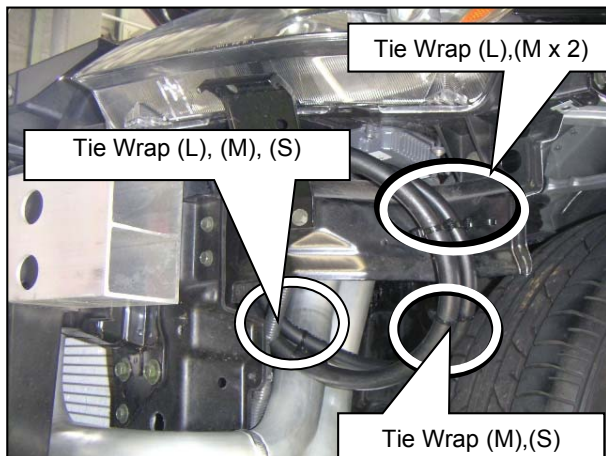
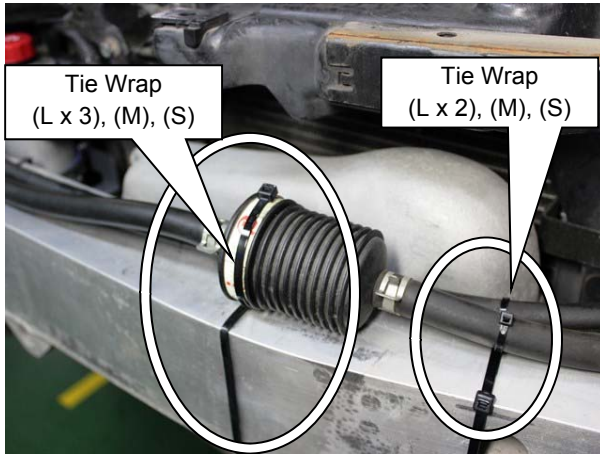
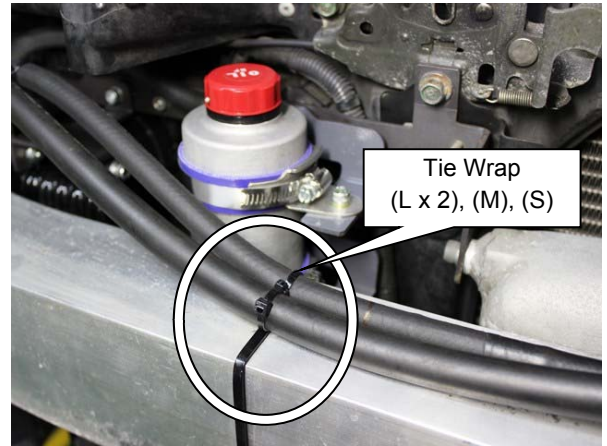
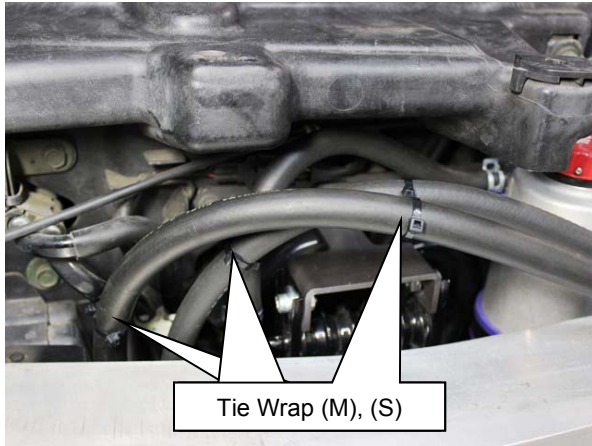

10. INSTALLATION OF INTERCOOLER PIPE②

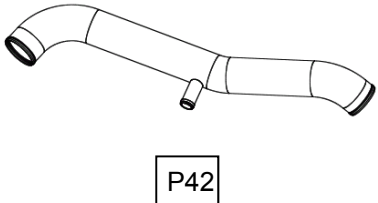

PARTS LIST

	No.	Description	QT
		P42	Pipe No.5
	P60	Hose 4mm L1000	1
	P55	Silicone Hose 80mm-60mm	1
	P58	Silicone Hose 60mm-50mm	1
	P79	Hose Band #16	1
	P80	Hose Band #28	1
	P81	Hose Band #36	2
	P83	Hose Band #48	1
	P95	Tie Wrap (L)	
	P97	Tie Wrap (S)	

(1) Cut the Hose 4mm to 770mm in length.

- Hose 4mm L1000 (P60)

(2) Remove ①plug installed to the upper intake manifold, connect the upper intake manifold and ②relief valve using the 770mm Hose. Secure the hose with a Tie Wrap (S).

- Tie Wrap (S) (P97)

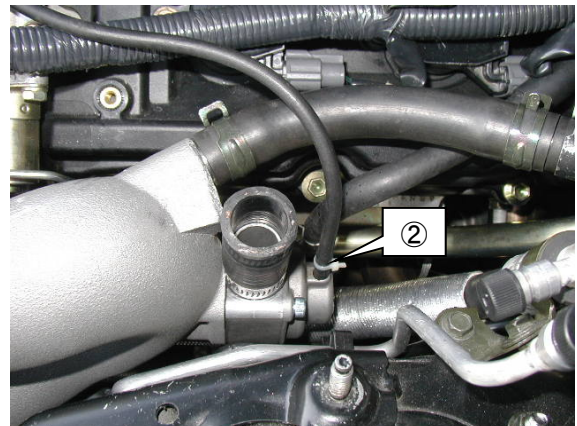
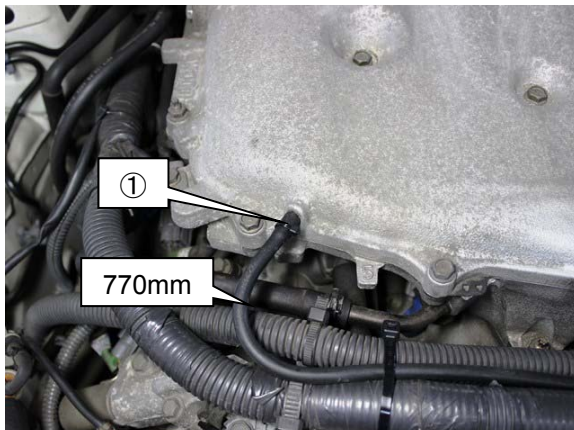

(3) Bundle the Hose 400mm with ①harness. Make sure not to distort the hose.

- Tie Wrap (L) (P95)

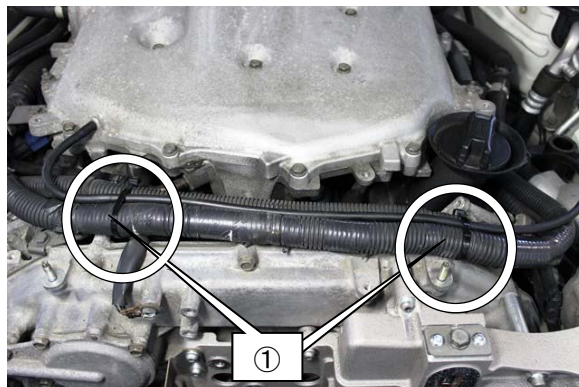

(4) Install ①Pipe No.5.

- Pipe No.5 (P42)
- Silicone Hose 80mm-60mm (P55)
- Silicone Hose 60mm-50mm (P58)
- Hose Band #16 (P79)
- Hose Band #28 (P80)
- Hose Band #36 (P81×2)
- Hose Band #48 (P83)

NOTE

- When installing the pipe, make sure the portion “A” in the diagram does not come in contact with the bonnet.

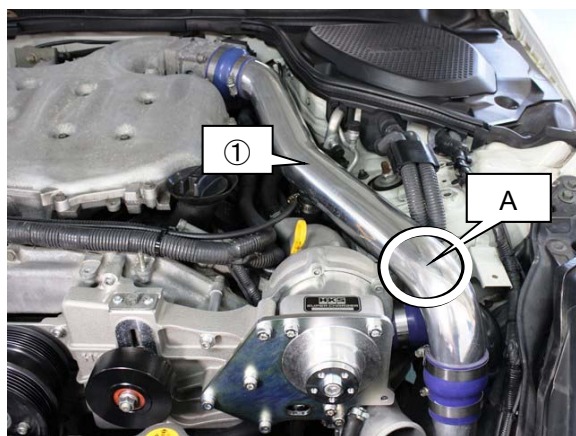

11. ADDING TRACTION FLUID

PARTS LIST

		No.	Description	QT
		P7	Traction Fluid	1
		P52	Hose Clamp 15.5mm	1

NOTE

- This step **MUST** be conducted prior to starting the engine. Starting the engine without adding the Traction Fluid can lead a damage to the supercharger internal.
- Do not allow any foreign objects to mix with the Traction Fluid. The internal component parts of the supercharger are very precise and exact; foreign objects mixed with Traction Oil can lead a damage to the supercharger unit.

(1) Check to make sure there are no foreign objects in the Traction Oil Tank. Add approximately 500cc of Traction Oil to the Oil Tank (up to the dotted line in the drawing), and close the lid.

※ Since the tank capacity is approximately 350cc, pour 350cc to the tank first, and after confirming the oil surface is lowered, pour the remained 150cc fluid.

- Traction Fluid (P7)

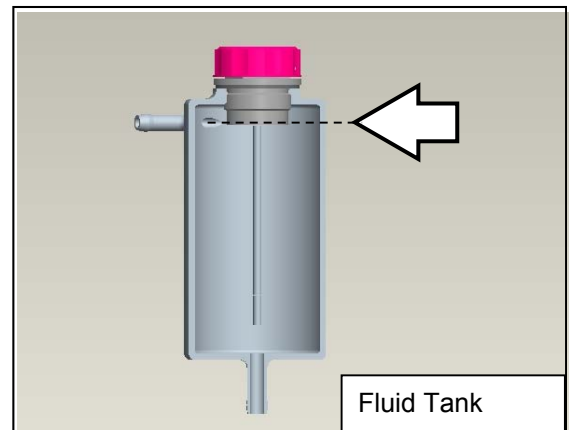

NOTE

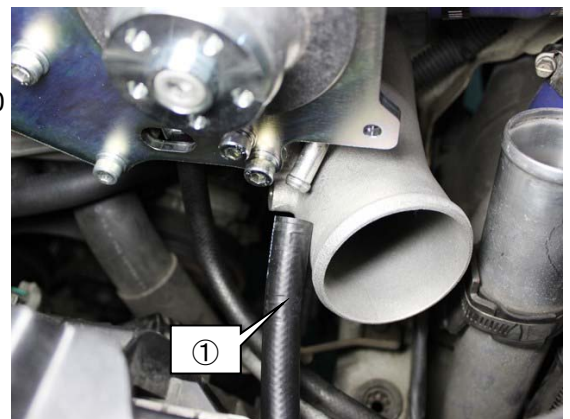

- Prepare a rag to wipe and clean any oil that overflows from the hose
- (2) Disconnect ①Hose 10mm temporarily installed to GT2-7040 in 9.(13).
 - (3) Temporarily install the Hose Clamp 15.5mm to the Hose 10mm.
 - Hose Clamp 15.5mm (P52)
 - (4) Remove the cap from the fluid tank. Cover the spout part of the tank with a clean cloth, and apply pressure for oil force feed.
 - (5) If oil overflows from ①Hose 10mm, re-connect the Hose 10mm to GT2-7040 and secure the hose with the Hose Clamp 15.5mm.
 - (6) Close the lid of the fluid tank.



12. INSTALLATION OF AIR CLEANER

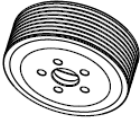
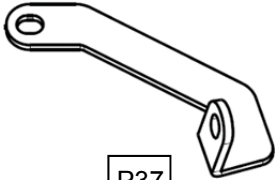

PARTS LIST

		No.	Description	QT
 P23	 P2	P2	S/C Pulley (φ95)	1
		P23	Air Cleaner	1
 P37	 P44	P37	Bracket No. 14	1
		P44	Spacer No.5 (φ14 - φ6.5 - L18)	2
		P54	Silicone Hose 70mm L55	1
		P68	Cap Bolt M6 L30	1
		P69	Cap Bolt M6 L40	1
		P76	Low-head Cap Bolt M6 L12	5
		P84	Flange Nut M6	1
		P82	Hose Band #40	1
		P83	Hose Band #48	1
		P87	Flat Washer M6	2

(1) Install ②Bracket No.14 with ①Spacer No.3.

- Bracket No.14 (P37)
- Spacer No.3 (φ14 - φ6.5 - L18) (P44×2)
- Cap Bolt M6 L30 (P68)
- Cap Bolt M6 L40 (P69)
- Flange Nut M6 (P84)
- Flat Washer M6 (P87×2)

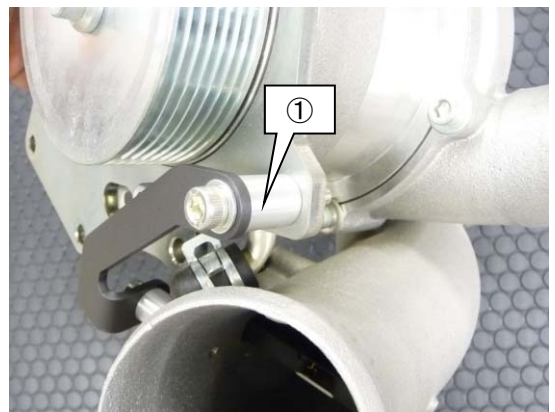
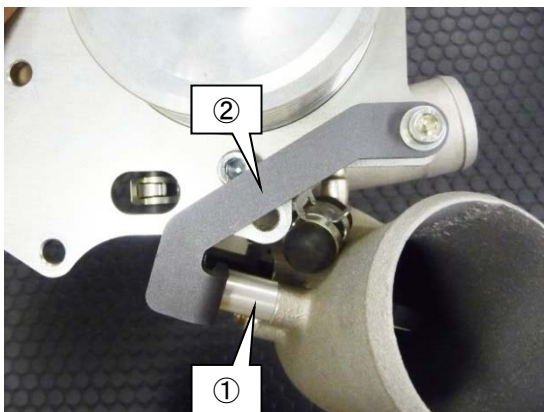

(2) Install ① S/C Pulley to GT2-7040.

- S/C Pulley (φ95) (P2)
 - Low-head Cap Bolt M6 L12 (P76×5)
- Tightening Torque N·m(kgf·m)
T=12(1.22)

(3) Install ② Air Cleaner to the vehicle. Make sure the cleaner does not come in contact with any other parts of a vehicle.

- Air Cleaner (P23)
- Silicone Hose 70mm L55 (P54)
- Hose Band #40 (P82)
- Hose Band #48 (P83)

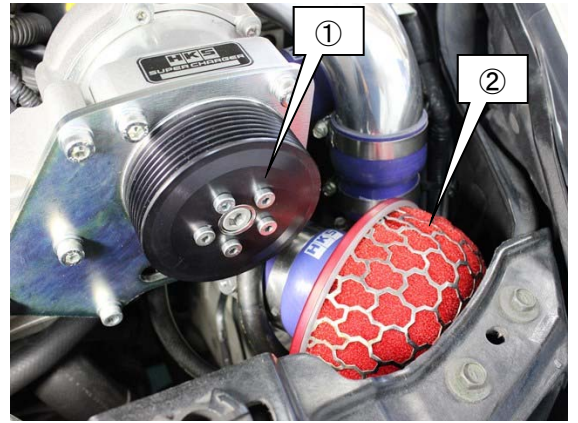

(4) Cut off a certain portion of ① air duct so it does not come in contact with the air cleaner, and install it to the vehicle.



13. INSTALLATION OF BELT

PARTS LIST

No.	Description	QT
P22	Belt 7PK1060	1

- (1) Check four ①Cap Bolt M6 L18 to see if they are tightened to 11.7~13.7 (1.2~1.4)N·m(kgf·m).



CAUTION

Use a torque wrench to tighten the bolts. If the tightening torque is insufficient or excessive, it may cause damage to the bolt and/or idler pulley may slip off during driving.

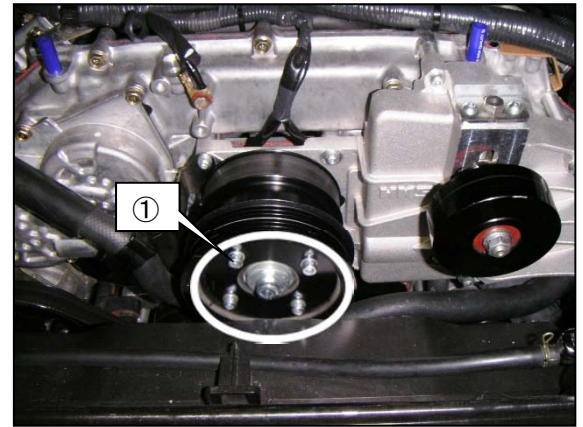

- (2) Install ①Belt 7PK 1060.

When the S/C pulley is installed to GT2-7040, use 7 ribs of the vehicle's rear side, and leave one rib of the vehicle's front side unused.

- Belt 7PK 1060 (P22)

- (3) Use a tension gauge to apply tension to the belt at ①"new" tension shown in Belt Tension Chart 1 in next page. Check the belt tension at the positions indicated by arrows in the diagram on the right.

NOTE

- For belt tension measurement, Mitsubishi Doctor Tension Type-III is recommended.

Tightening Torque N·m(kgf·m)

Factory Idler Nut (②): T=31.4~38.2(3.2~3.9)

Tensioner Pulley Nut (③): T=31.4~38.2(3.2~3.9)

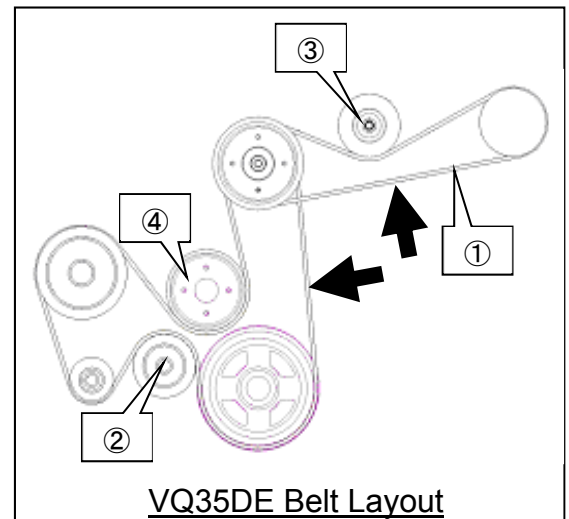

VQ35DE Belt Layout

- (4) Tighten four Bolt M6 of ④Idler pulley No.1.

Tightening Torque N·m(kgf·m)

T=5.9~9.8(0.61~0.99)

NOTE

- The belt tension will settle in about 2-20 hours after installation. After it settles in, re-measure the belt tension to make sure that the tension matches the specs as ② "In Use" on the table. Make adjustments if necessary.

Table 1. Belt Tension

Belt	Belt Span	①New (N { kg })	②In Use (N { kg })
6PK1700 (Crank Pulley Side)	295mm	950 (97.0)	760 (77.6)
7PK1060 (Supercharger Side)	348mm	790 (80.6)	630 (64.3)

- ※ 1) "Belt Span" is the distance between pulley axes when measuring the tension at the points indicated by arrows in the diagram below.
- ※ 2) Belt Specific Gravity: 0.0188kg/(1rib x 1m in length)

 CAUTION

- Make sure the belt is correctly aligned with the groove on the pulley. Failure to do so may cause damage to the belt.
- Adjust the tension to the standard right after installing the belt. Rotate the crankshaft at least twice to adjust uneven tension. Make sure the tension is set to the standard value.
- Make sure oil and/or coolant does not get on the belt.
- If the belt tension is not set to the correct tension, the bonnet may come in contact with the tensioner pulley. Prior to closing the bonnet/hood, make sure there is at least 35mm of clearance as depicted in section ① of the below diagram.

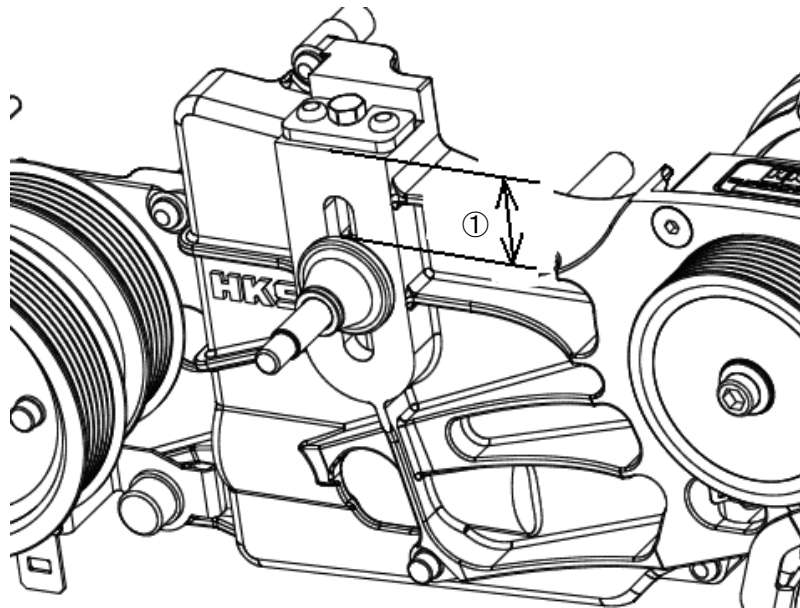

14. INSTALLATION OF FACTORY PARTS

- (1) Reconnect the negative cable to the battery.
- (2) Sound the horn and make sure the horn fuse is not blown.
If the horn fuse is blown, wiring for the horn may be incorrect.
- (3) After making sure the horn works properly, disconnect the negative cable from the battery.
- (4) Reinstall the bumper.

- (5) Cut off the portion where the engine cover comes in contact with the supercharger bracket and pulley; then, install the cover to the engine.
- (6) Install the strut tower bar.

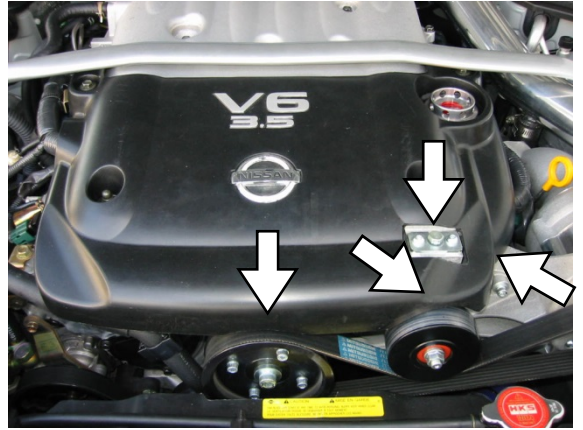

- (7) Install the engine under cover.

NOTE

- The engine under cover must be reinstalled.

- (8) Reconnect the negative cable to the battery.

- (9) Perform engine management using F-con iS, F-con Vpro, or a similar device to start the engine.

15. CONFIRMATION AFTER INSTALLATION

Check the following after installation is completed.

(1) Check the following before starting the engine:

	Confirmation	Check
1	Make sure the traction fluid piping is correct.	
2	Make sure the wiring harnesses and installed components are not in contact with other parts.	
3	Make sure the harness is not pinched at any place.	
4	Make sure the belt is tightened to the designated spec.	
5	Make sure bolts and the bolt that secures the pulley are tightened properly.	
6	Make sure traction fluid is at marking level of the level gauge.	
7	Make sure pipes and hoses are routed and connected correctly.	
8	Make sure hoses are not twisted or bent excessively.	
9	Make sure all hose clamps are tightened properly.	
10	Make sure all bolts and nuts are tightened properly.	
11	Make sure all installed components are secured properly.	
12	Make sure the negative cable terminal is securely attached to the battery.	
13	Make sure the level gauge for the engine oil is between H – L.	

(2) Prepare 80cc of the traction fluid in a beaker or small container, and start the engine.

(3) Perform the following immediately after starting the engine:

1. Check to make sure that the traction fluid level starts to decline, then increase again.
 2. Add the traction fluid from 80cc beaker or a small container before the fluid gets empty. Make sure that the fluid does not overflow.
- ※ There may be unusual noise emanating from the supercharger after turning on the engine. This is normal symptom as this noise stops after the traction fluid warms up (approx. 2-3 minutes.).

(4) Start the engine and perform the following after the engine reaches the normal operating temperature:

NOTE

- Do not raise the engine RPM while the engine is reaching to the normal operation temperature. (Let it idle.)

	Confirmation	Check
1	Make sure the traction fluid returns to the tank.	
2	Make sure the traction fluid and air are not leaking.	
3	Make sure there is no excessive stress on harnesses, fuel lines, and hoses.	
4	Make sure the installed parts are not hitting each other.	

- (5) After checking the above items, keep the engine RPM stable at 2,000rpm for about 10 seconds; shut the engine off and check the traction fluid level gauge to see if the fluid level is at level ① as shown in the diagram below. If not, make a proper adjustment.

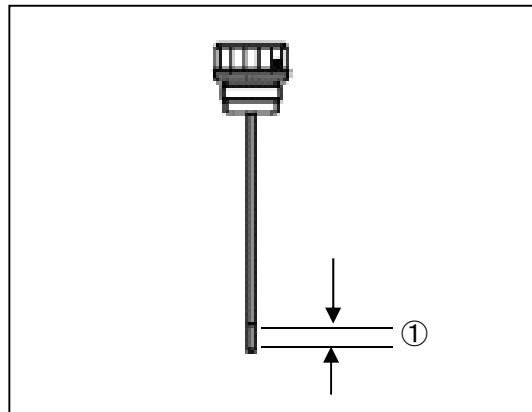

- ※ **If there is traction fluid remaining in the bottle, replace the cap on the bottle and store in a safe location. Always store excess traction oil in the original bottle. Failure to do so may damage the bottle and/or change to the ingredients.**

- (6) After adjusting the traction fluid level, close the lid.

The installation process is now complete.

16. FIRST MONTH INSPECTION

Within 40 days of installation, consult your installer/retailer for the following 1st month inspection:

Entry Method	No Problem	<input checked="" type="checkbox"/> Exchange	<input checked="" type="checkbox"/> Adjust	<input type="checkbox"/> A Tighten	<input type="checkbox"/> T
--------------	------------	--	--	------------------------------------	----------------------------

1 st Month Inspection Items	
1	<p><u>Supercharger Base Unit Checks</u></p> <div style="border: 1px solid black; padding: 5px; text-align: center;">  WARNING </div> <ul style="list-style-type: none"> • When checking operation of the unit, avoid touching any moving belts, even clothing. • Touching these moving belts can lead to severe injury and damage. <p>Compare the operating sound currently against initial installation, check for increased sound levels or unusual noises. <input type="checkbox"/></p> <p>Compare the sound of the air cleaner against initial installation, check for increased intake sound levels or unusual noises. <input type="checkbox"/></p> <p>Check traction fluid level for unusually high traction oil consumption. (Oil level surface is not touching the oil level gauge) <input type="checkbox"/></p>
2	<p><u>Traction Oil Piping Inspection</u></p> <p>Check for traction fluid leaking from the piping, loose hose clamps <input type="checkbox"/></p> <p>Locations:</p> <ul style="list-style-type: none"> • Connection point to the supercharger <input type="checkbox"/> • Connection point to the oil cooler <input type="checkbox"/> • Connection point to the oil tank <input type="checkbox"/> • Connection point to the oil filter <input type="checkbox"/> <p>Signs of damage due to rubbing of the traction hose to other parts <input type="checkbox"/></p> <p>Cracks or breaks in the traction hose <input type="checkbox"/></p> <p>If traction fluid filled to the marking level on the oil level gauge <input type="checkbox"/></p>
3	<p><u>Belt Inspection</u></p> <p>Check if belts have proper tension <input type="checkbox"/></p> <ul style="list-style-type: none"> • 6PK1700: Over 760N (77.6kg·m) <input type="checkbox"/> • 7PK1060: Over 630N (64.3kg·m) <input type="checkbox"/> <p>Cracks or breaks in the belts <input type="checkbox"/></p> <p>Check if belt is rubbing against or interfering with Bracket No. 8 <input type="checkbox"/></p>
4	<p><u>Bolt Tightening</u></p> <p>Check if Supercharger Assy mounting bolt is tightened. <input type="checkbox"/></p> <p>Check if pulley mounting and support bolts are properly tightened <input type="checkbox"/></p>
5	<p><u>Other</u></p> <p>Check if any harnesses are not in contact with any other parts. <input type="checkbox"/></p> <p>Check if all installed parts are not in contact with any other parts. <input type="checkbox"/></p> <p>Check Points:</p> <ul style="list-style-type: none"> • Air Cleaner and Radiator <input type="checkbox"/> • Pipe No.5 and Bonnet <input type="checkbox"/> • Pipe No.1 and A/C Pipe <input type="checkbox"/> <p>Check if all hose clamps are properly tightened. <input type="checkbox"/></p> <p>Check if the engine oil level is within H-L range. <input type="checkbox"/></p>

17. MAINTENANCE / MANAGEMENT

- Traction fluid is used specifically for the HKS GT2 Supercharger. Do not use other types of fluids; use of other brands of traction fluid, engine oil, or transmission oil can lead to damage to the HKS GT2 Supercharger internals.
- Traction fluid does not need to be replaced, however check the fluid level prior to driving. If oil level is low, add traction oil as necessary.
 - Use the part number below to order the Traction Oil.

Product Name	Part Number
GT S/C Traction Fluid I	12002-AK029

- Replace the traction fluid filter after 5 years or 70,000km after installing the HKS GT2 Supercharger.
 - Use the part number below to order the traction fluid filter.

Product Name	Part Number
Oil Filter Element	12002-AK015

- Belts are consumable parts. Always check belts prior to driving for any cracks or tears.
 - Replace damaged belts immediately. Use the following chart for belt replacement:

Product Name	Part Number	Remarks
FINE TUNE V-BELT 6PK1700	24996-AK017	Crank Pulley Side
FINE TUNE V-BELT 7PK1060	24996-AK023	Supercharger Side

- Replace the element every 2,000 to 3,000km (1,300 to 1,900 miles) of driving. (Do not wash the element.) There are certain conditions where, depending on dirt buildup, the filter may need to be replaced earlier than the above recommended intervals.
 - Use the part number below to order the replacement element.

Product Name	Part Number
150mm Replacement Element (Wet 2-layer Type)	1504-SA012 (Yellow) · 70001-AK031 (Red)

- Do not use the air cleaner from HKS Power Flow Reloaded (70019-AK002) and 150mm dry 3-layer type (70001-AK021).

18. TROUBLESHOOTING

- If this product is not working properly, check the list below and take necessary measures.

Symptom	Cause	Measure
<ul style="list-style-type: none"> • Belt squeals when engine starts. • Engine output feels weak. • At full throttle the boost starts to reduce at a certain RPM while engine RPM is increasing. 	Low belt tension	<ul style="list-style-type: none"> • Reset the belt tension to the required spec listed in Belt Tension Table. • If the belt tension does not reach the required spec, replace with a brand new belt.
<ul style="list-style-type: none"> • Engine output feels weak. • At full throttle the boost starts to reduce at a certain RPM while engine RPM is increasing. 	Air filter worn out	<ul style="list-style-type: none"> • Replace the filter element when the driving distance after installing this product exceeds 2,000km. • Replace the filter depending on dirt buildup.
<ul style="list-style-type: none"> • The grease from the bearing on the tension pulley is spraying. 	Surplus grease from the bearing.	<ul style="list-style-type: none"> • Grease from the bearing is spraying out from the bearing shield. Wipe clean with a rag. • If the spraying continues even after wiping clean, and/or strange noises are being emitted, consult your installer.

19. If the Belt Breaks

Park the vehicle in a safe place to check if the car is still drivable. Make sure if there is any damage caused by the torn belt such as oil leak, coolant leak, damaged harness, and etc. Even if the vehicle is still drivable, depending on the condition of the torn belt, be very cautious and drive very slowly. (Keep the speed below 35mph and 2,500rpm)

- If the S/C Belt (7PK1060) breaks:
Slow cruising is possible. Move the vehicle to a safe place and replace the belt with a brand new one. Repair any problems that may have caused the belt to break.
- If the Crank Pulley Belt (6PK1700) breaks
Since the alternator is not driven, the vehicle can be driven slowly until the battery runs out. Also, since the power steering pump is also not driven, the steering will be very hard. Move the vehicle to a safe place and replace the belt with a brand new one. Repair any problems that may have caused the belt to break.



HKS Co., Ltd.

7181 Kitayama, Fujinomiya, Shizuoka 418-0192, Japan

<http://www.hks-power.co.jp/>