



## INSTALLATION MANUAL

NAME OF PRODUCT	GT2 SUPERCHARGER SYSTEM PRO KIT																		
PART NUMBER	12001-AH010																		
APPLICATION	HONDA S2000 (AP1/AP2) ※ Application for Type V and the vehicle equipped with a wire throttle control system have not been confirmed, yet.																		
ENGINE	F20C/F22C																		
YEAR	JDM: 1999/4~2007/9    USDM: 06~09 Model																		
REMARKS	<ul style="list-style-type: none"> <li>• <b>High octane gasoline must be used.</b></li> <li>• Applicability of this kit to the vehicle equipped with a Wire throttle control system (~05 model) has not been confirmed, yet; therefore, additional parts and/or modifications may be required.</li> <li>• Temperatures of oil and water must be managed properly during driving.</li> <li>• HKS will not be responsible for any and all damage to the vehicle's engine or other supplemental devices through the use of this product.</li> <li>• This product is best used with the following parts on the Recommended Parts List. HKS will not be responsible for any damage caused by using this product with any other parts.</li> </ul> <table border="1" style="width: 100%; border-collapse: collapse; margin-top: 10px;"> <tr> <th colspan="2" style="text-align: center;">Pro Kit Designated Parts List</th> </tr> <tr> <td style="width: 50%;">Spark Plug</td> <td>HKS Super Fire Racing M45i or higher range.</td> </tr> <tr> <td>Engine Oil</td> <td>HKS Engine Oil (Oil Viscosity must be 40 or higher.)</td> </tr> <tr> <th colspan="2" style="text-align: center;">Pro Kit Recommended Parts List</th> </tr> <tr> <td>Exhaust Manifold</td> <td>OEM or HKS Stainless Exhaust Manifold (Insulation is required to use HKS Stainless Manifold.)</td> </tr> <tr> <td>Catalytic Converter</td> <td>OEM or HKS Metal Catalyzer</td> </tr> <tr> <td>Muffler/Exhaust</td> <td>OEM or HKS Super Sound Master or HKS Silent Hi-Power Muffler</td> </tr> <tr> <td>Fuel Upgrade Parts</td> <td>HKS Fuel Upgrade Kit for GTSC ※Available only for a JDM vehicle.</td> </tr> <tr> <td>Engine Control Unit</td> <td>HKS F-CON iS ※Available only for a JDM vehicle equipped with the wire throttle control system. HKS Flash Editor ※Available only for a JDM vehicle equipped with the electronic throttle control system.</td> </tr> </table> <p>HKS will not be responsible for any damage caused by the use of this product beyond the impeller's maximum RPM limit (110,000rpm) and/or the specified engine RPM.</p>	Pro Kit Designated Parts List		Spark Plug	HKS Super Fire Racing M45i or higher range.	Engine Oil	HKS Engine Oil (Oil Viscosity must be 40 or higher.)	Pro Kit Recommended Parts List		Exhaust Manifold	OEM or HKS Stainless Exhaust Manifold (Insulation is required to use HKS Stainless Manifold.)	Catalytic Converter	OEM or HKS Metal Catalyzer	Muffler/Exhaust	OEM or HKS Super Sound Master or HKS Silent Hi-Power Muffler	Fuel Upgrade Parts	HKS Fuel Upgrade Kit for GTSC ※Available only for a JDM vehicle.	Engine Control Unit	HKS F-CON iS ※Available only for a JDM vehicle equipped with the wire throttle control system. HKS Flash Editor ※Available only for a JDM vehicle equipped with the electronic throttle control system.
Pro Kit Designated Parts List																			
Spark Plug	HKS Super Fire Racing M45i or higher range.																		
Engine Oil	HKS Engine Oil (Oil Viscosity must be 40 or higher.)																		
Pro Kit Recommended Parts List																			
Exhaust Manifold	OEM or HKS Stainless Exhaust Manifold (Insulation is required to use HKS Stainless Manifold.)																		
Catalytic Converter	OEM or HKS Metal Catalyzer																		
Muffler/Exhaust	OEM or HKS Super Sound Master or HKS Silent Hi-Power Muffler																		
Fuel Upgrade Parts	HKS Fuel Upgrade Kit for GTSC ※Available only for a JDM vehicle.																		
Engine Control Unit	HKS F-CON iS ※Available only for a JDM vehicle equipped with the wire throttle control system. HKS Flash Editor ※Available only for a JDM vehicle equipped with the electronic throttle control system.																		

## REVISION OF MANUAL

Rev. Number	Date	Manual Number	Details
3-3.01	2018/4	E04215-H44050-00	1 <sup>st</sup> Edition
3-3.02	2018/5	E04215-H44051-00	2 <sup>nd</sup> Edition
3-3.03	2018/10	E04215-H44052-00	3 <sup>rd</sup> Edition

Published in May 2018 by HKS Co., Ltd. (Unauthorized reproduction is strictly prohibited.)

## INDEX

NOTICE/ATTENTION/SAFETY PRECAUTION .....	2
PARTS LIST .....	4
1. REMOVAL OF FACTORY PARTS .....	8
2. INSTALLATION OF TRACTION FLUID COOLER .....	14
3. INSTALLATION OF SUPERCHARGER .....	21
4. INSTALLATION OF INTERCOOLER & PIPING .....	39
5. REINSTALLATION OF FACTORY PARTS .....	61
6. FILLING TRACTION FLUID .....	61
7. CONFIRMATION AFTER INSTALLTION & CHECKING TRACTION FLUID VOLUME .....	62

## NOTICE

This manual assumes that you have and know how to use the tools and equipment necessary to safely perform service operations on your vehicle. This manual assumes that you are familiar with typical automotive systems and basic service and repair procedures. Do not attempt to carry out the operations shown in this manual unless these assumptions are correct. Always have access to a factory service manual. To avoid injury, follow the safety precautions contained in the factory service manual.

## ATTENTION

- This manual indicates items you need to pay attention to in order to install this product safely and lists precautions to avoid any possible damage and/or accidents.
- This product is an automobile part. Do not use for any other purposes.
- HKS will not be responsible for any damage caused by incorrect installation and/or use, or use after modification and/or dismantling of this product.
- This product was designed for installation on a specific factory vehicle.
- The specifications of this product are subject to change without notice.
- The instructions are subject to change without notice. Make sure to refer to the most recent instructions.
- This manual includes instructions that are required only for a specific vehicle type. Refer to the instructions with asterisks to follow correct instructions for your vehicle.
- This kit includes parts that are required for a specific application. Refer to the parts list on the following page to use correct parts for your vehicle.

## SAFETY PRECAUTION

The impeller's maximum RPM should not exceed 110,000 rpm. HKS will not be responsible for any damage caused by the use of this product beyond the impeller's maximum RPM limit.



## PARTS LIST

NO.	DESCRIPTION	QT	REMARKS
1	Supercharger Unit	1	GT2-7040
2	Traction Fluid Filter	1	
3	Traction Fluid Tank	1	
4	Traction Fluid	1	
5	Traction Fluid Cooler	1	
6	Idler Pulley	2	
7	Crank Pulley	1	
8	Supercharger Crank Pulley	1	
9	Supercharger Unit Pulley	1	120mm
10	Belt	1	6PK1319
11	Intercooler	1	
12	Relief Valve Assembly	1	
13	Air Cleaner	1	150-70mm 2-layers Wet Type
14	Hose 4mm	2	1000mm ※Use only 1 piece for a vehicle with the electronic throttle control system.
15	Hose 8mm	1	3000mm
16	Hose 10mm	1	1250mm
17	Hose 12mm	1	1000mm
18	Hose 22mm	1	1000mm
19	T-fitting 4-4-4	1	※Not required for a vehicle with the electronic throttle control system.
20	T-fitting 8-4-8	1	※Not required for a vehicle with the wire throttle control system.
21	T-fitting 22-19-22	1	※Not required for a vehicle with the electronic throttle control system.
22	Corrugated Tube 8mm	1	
23	Corrugated Tube 10mm	1	
24	Corrugated Tube 12mm	1	
25	Corrugated Tube 22mm	1	

26	Intercooler Inlet Pipe No.1	1	
27	Intercooler Inlet Pipe No.2	1	
28	Intercooler Outlet Pipe No.1	1	
29	Intercooler Outlet Pipe No.2	1	
30	Intercooler Outlet Pipe No.3	1	
31	Suction Pipe No.1	1	
32	Suction Pipe No.2	1	
33	Joint Pipe 8mm	1	
34	Supercharger Bracket No.1	1	
35	Supercharger Bracket No.2	1	
36	Supercharger Bracket No.3	1	
37	Supercharger Bracket No.4	1	Restrictor:φ37.5
38	Supercharger Bracket No.4	1	Restrictor:φ58
39	Tensioner Bracket	1	
40	Traction Fluid Tank Bracket No.1	1	
41	Traction Fluid Tank Bracket No.2	1	
42	Traction Fluid Filter Bracket	1	
43	Traction Fluid Cooler Bracket No.1	1	
44	Traction Fluid Cooler Bracket No.2	1	
45	Traction Fluid Cooler Bracket No.3	1	
46	Intercooler Inlet Pipe Bracket	1	
47	Intercooler Outlet Pipe Bracket	1	
48	Suction Pipe Bracket	1	
49	Intercooler Bracket No.1	1	
50	Intercooler Bracket No.2	1	
51	2nd Air Control SOL.V Bracket	1	※Not required for a vehicle with the electronic throttle control system.
52	ABS Modulator Bracket	2	※Not required for a USDM vehicle.
53	Relay Box Bracket No.1	1	※Not required for a JDM vehicle.

54	Relay Box Bracket No.2	1	※Not required for a JDM vehicle.
55	Relay Box Bracket No.3	1	※Not required for a JDM vehicle.
56	Horn Bracket	1	※Not required for a JDM vehicle.
57	Universal Pipe Bracket 50mm	1	
58	Universal Pipe Bracket 60mm	5	
59	Suction Pipe Gasket	2	
60	Insulator Rubber	4	
61	Intake Air Temperature Sensor	1	※Not required for a vehicle with the wire throttle control system.
62	Intake Air Temperature Sensor Harness	1	※Not required for a vehicle with the wire throttle control system.
63	Silicone Hose 50mm L=20	1	
64	Silicone Hose 50mm L=55	1	
65	Silicone Hose 55mm L=43	1	
66	Silicone Hose 60mm L=70	4	
67	Silicone Hose 70mm L=20	2	
68	Silicone Hose 70mm L=70	1	
69	Silicone Hose 60mm-70mm	1	
70	Cushion Hose 60mm L=75	2	
71	Spacer M6 L=3	3	※Use only 2 pieces for a vehicle with the electronic throttle control system. ※Use only 1 piece for a USDM vehicle.
72	Spacer M6 L=4	2	
73	Spacer M6 L=10	4	
74	Spacer M6 L=32	2	
75	Spacer M8 L=10	2	
76	Spacer M10 L=7.5	1	
77	Spacer M10 L=10	1	
78	Spacer M10 L=32	1	
79	Hose Clip 8mm	5	
80	Hose Clip 10mm	2	

81	Hose Clip 12mm	2	
82	Hose Clip 22mm	4	※Use only 2 pieces for a vehicle with the electronic throttle control system.
83	Hose Clamp #28	3	
84	Hose Clamp #36	17	
85	Hose Clamp #40	5	
86	Stud Bolt M10 10-6-20	1	
87	Hexagon Bolt M6 L=15	8	
88	Hexagon Bolt M6 L=20	1	
89	Hexagon Bolt M6 L=25	5	
90	Hexagon Bolt M8 L=15	4	※Use only 3 pieces for a vehicle with the electronic throttle control system.
91	Hex Flange Bolt M6 L=30	4	
92	Hex Flange Bolt M8 L=16	4	
93	Cap Bolt M5 L=15	6	
94	Cap Bolt M6 L=12	5	Low head type
95	Cap Bolt M6 L=60	2	
96	Cap Bolt M6 L=80	2	
97	Cap Bolt M8 L=20	1	
98	Cap Bolt M8 L=65	2	
99	Cap Bolt M10 L=25	1	P=1.5
100	Cap Bolt M10 L=25	2	P=1.25
101	Cap Bolt M10 L=50	2	
102	Cap Bolt M10 L=80	1	
103	Dish Bolt M8 L=35	3	
104	Copper Washer M6	1	
105	Sponge Sheet	3	
106	Washer M5	6	
107	Washer M6	3	
108	Washer M8	3	

109	Washer M10	6	
110	Large Diameter Washer M6	21	※Use 20 pieces for a vehicle with the electronic throttle control system. ※Use 19 pieces for a USDM vehicle.
111	Large Diameter Washer M8	7	
112	Nut M6	2	※Not required for a USDM vehicle.
113	Flange Nut M6	9	※Use 7 pieces for a USDM vehicle.
114	Flange Nut M8	4	
115	Flange Nut M10	3	Serrated
116	Flange Nut M10	2	Not Serrated
117	Tie Wrap (L)	15	
118	Tie Wrap (M)	20	
119	Tie Wrap (S)	25	
120	Instruction Manual	1	For Supercharger Kit
121	Installation Manual	1	For Supercharger Kit



## 1. REMOVAL OF FACTORY PARTS

Refer to this instruction manual and the factory service manual to remove the factory parts.

(1) Disconnect the negative cable from the battery.

(2) Remove the front bumper.

(3) Remove the front under cover.

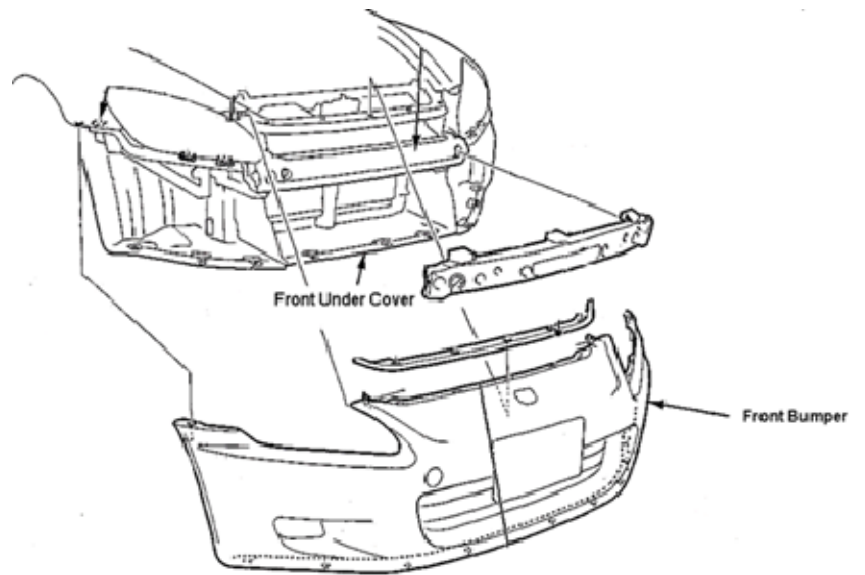

(4) Remove the splash guard.

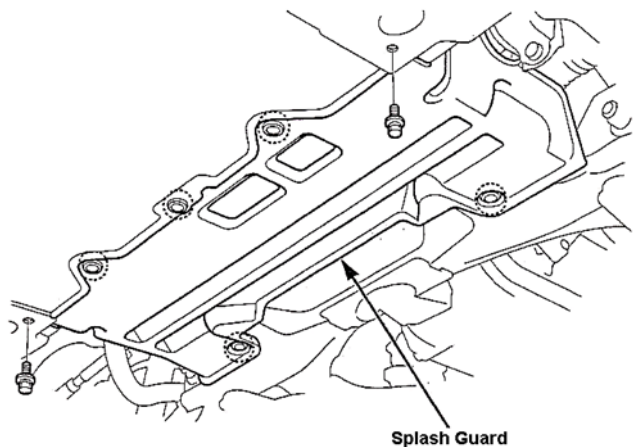

(5) Remove the inner fender from both sides.

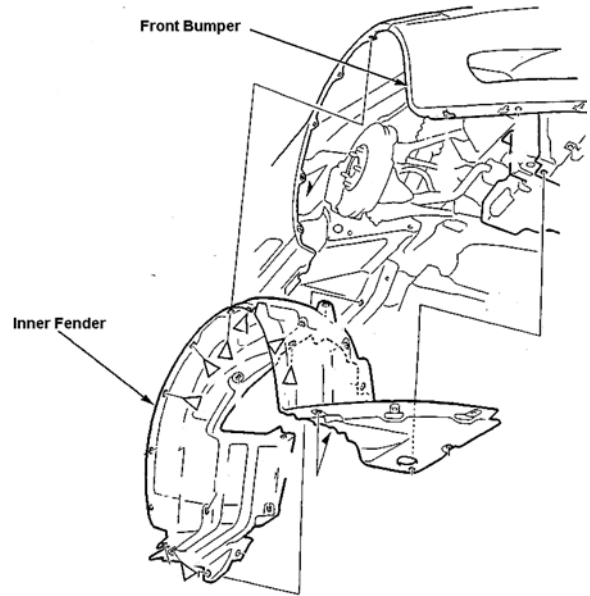

---

※(6)~(11) This procedure is required only for a vehicle with the wire throttle control system.

(6) Remove the 2nd air control SOL.V. from the air cleaner assembly.

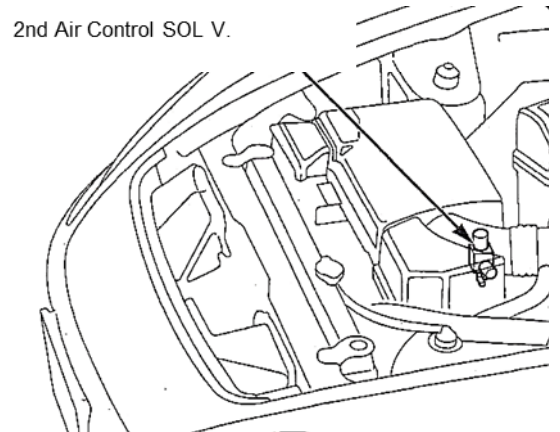

---

(7) Remove the air cleaner assembly.

(8) Remove the air cleaner assembly bracket.

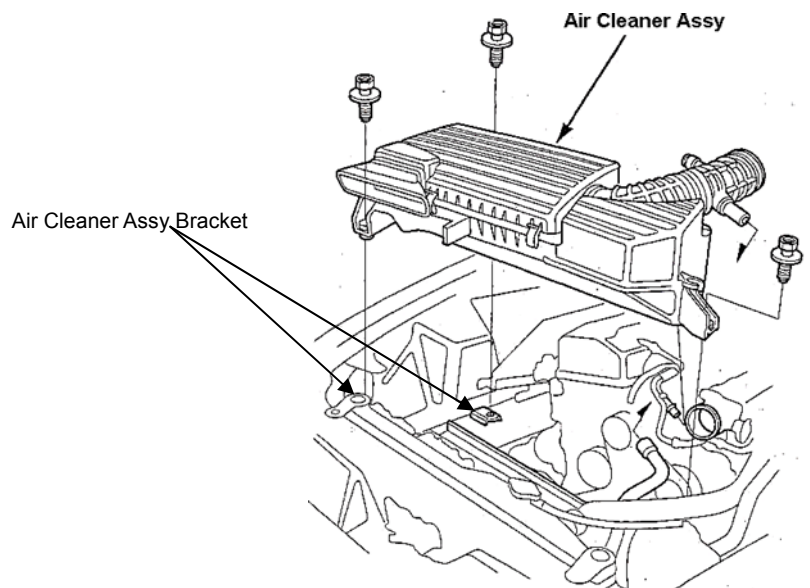

(9) Remove the intake air temperature sensor coupler and breather pipe; then, remove the air cleaner housing cover and air cleaner element assembly.

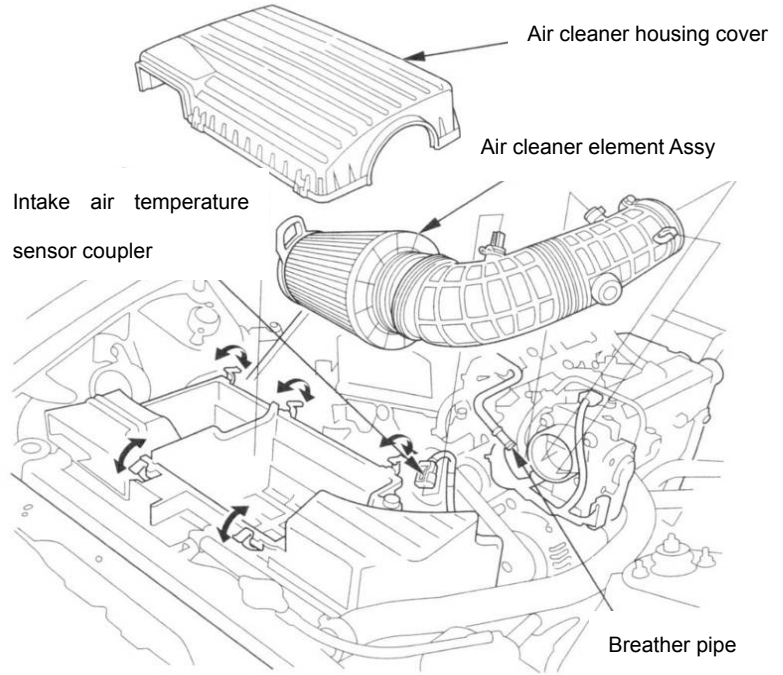

(10) Remove the intake air temperature sensor harness clamp and air cleaner housing.

(11) Remove the air cleaner bracket.

**NOTE**

• 1 of the air cleaner assembly bracket will be reused later.

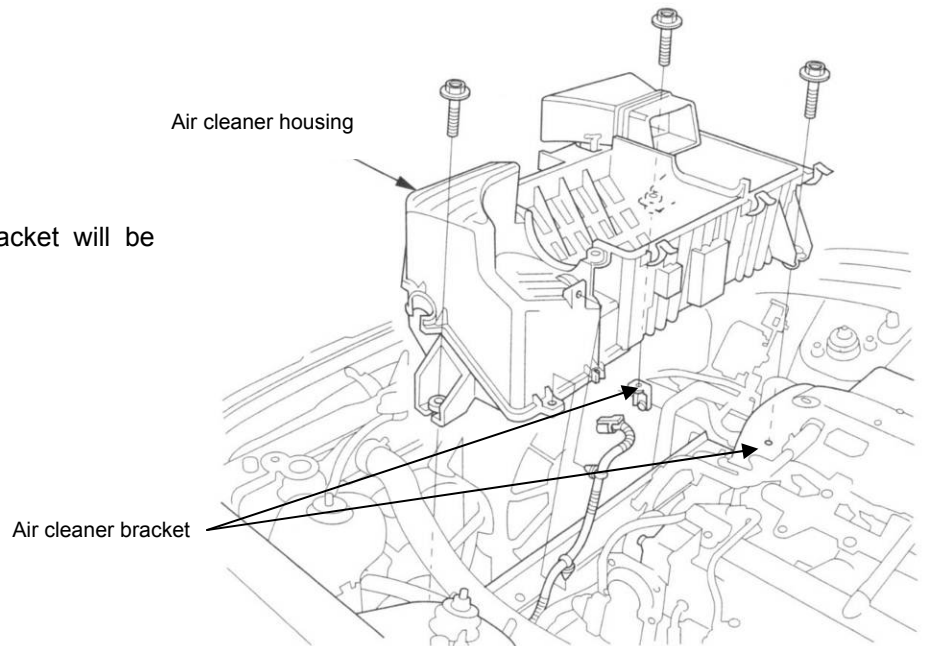

(12) Remove the heat shield.

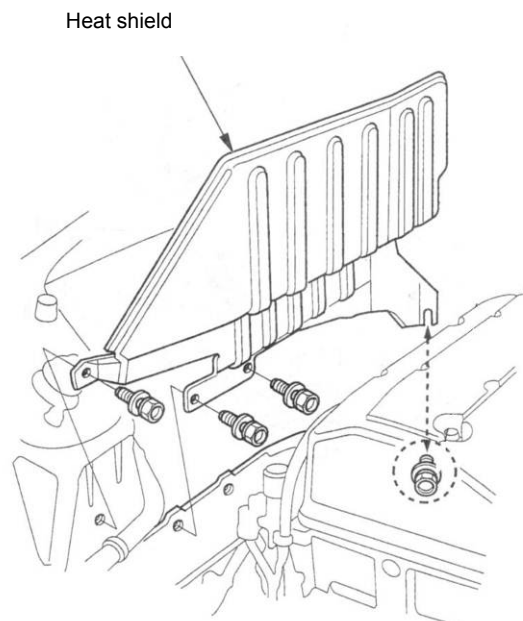

(13) Remove the exhaust manifold cover.

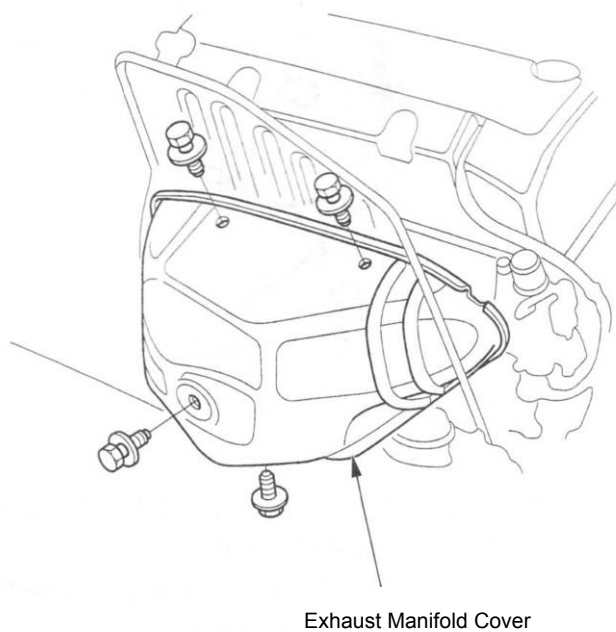

(14) Remove the front air guide.

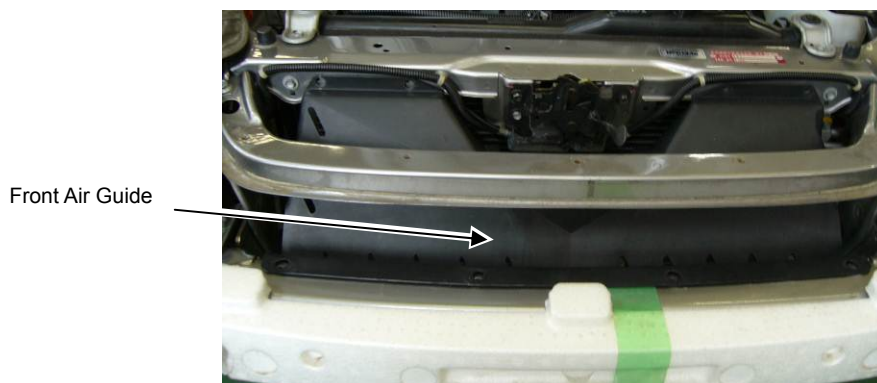

(15) Remove the front performance rod.

※This procedure is required only for a vehicle equipped with the front performance rod.

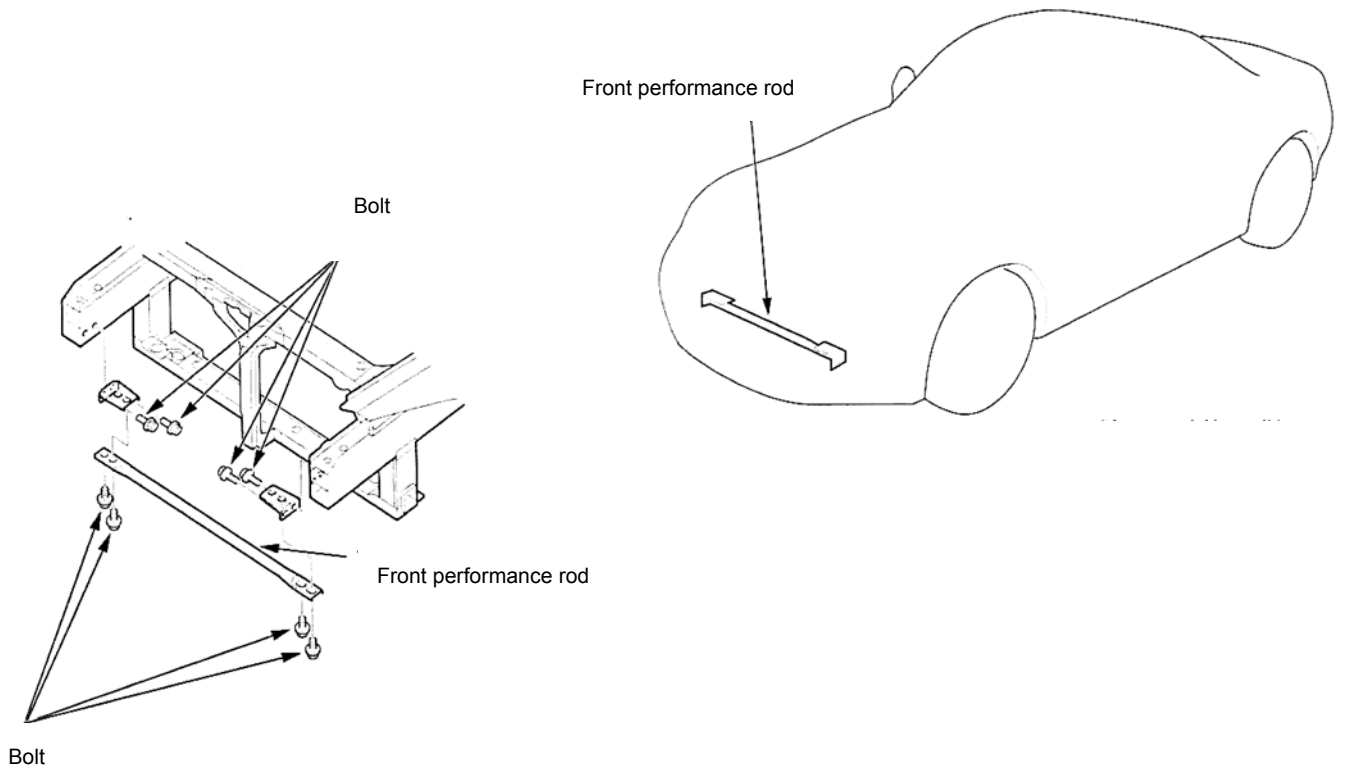

(16) Remove the crank pulley and replace it with the provided Crank Pulley.

**NOTE**

•Use a stopper available from HONDA.

**Tightening Torque N·m(kgf·m)**  
T=245(25.0)



## 2. INSTALLATION OF TRACTION FLUID COOLER

### PARTS LIST

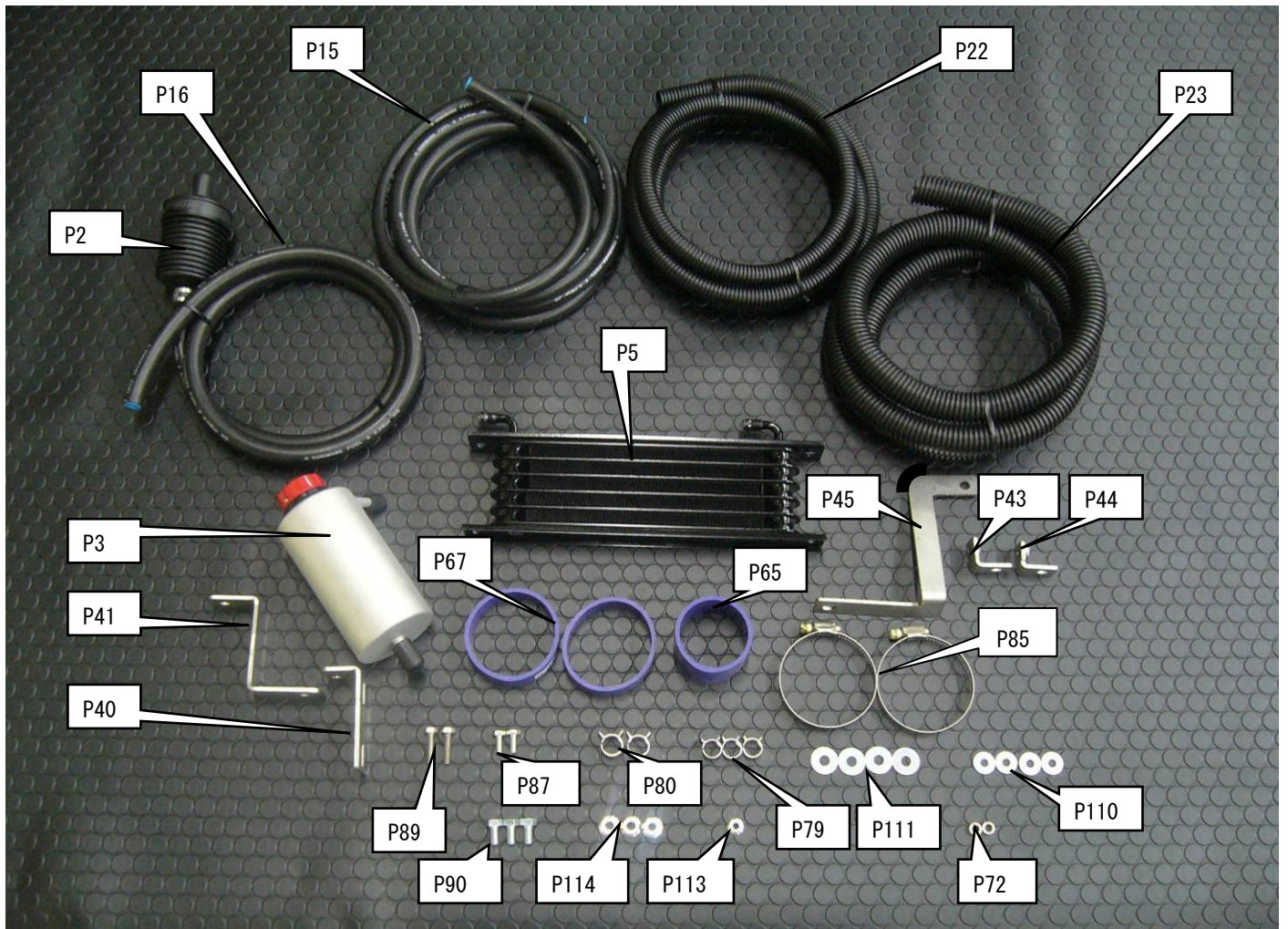

NO.	DESCRIPTION	QT
P2	Traction Fluid Filter	1
P3	Traction Fluid Tank	1
P5	Traction Fluid Cooler	1
P15	Hose 8mm	1
P16	Hose 10mm	1
P22	Corrugated Tube 8mm	1
P23	Corrugated Tube 10mm	1
P40	Traction Fluid Tank Bracket No.1	1
P41	Traction Fluid Tank Bracket No.2	1
P43	Traction Fluid Cooler Bracket No.1	1
P44	Traction Fluid Cooler Bracket No.2	1
P45	Traction Fluid Cooler Bracket No.3	1
P65	Silicone Hose 55mm L=43	1
P67	Silicone Hose 70mm L=20	2
P72	Spacer M6 L=4	2
P79	Hose Clip 8mm	3

P80	Hose Clip 10mm	2
P85	Hose Clamp #40	2
P87	Hexagon Bolt M6 L=15	2
P89	Hexagon Bolt M6 L=25	2
P90	Hexagon Bolt M8 L=15	3
P110	Large Diameter Washer M6	4
P111	Large Diameter Washer M8	4
P113	Flange Nut M6	1
P114	Flange Nut M8	3



**CAUTION**

**The internal components of the Supercharger Assembly are very precise and exact; foreign objects mixed with Traction Fluid can lead to damage to the Supercharger Assembly. Do not allow foreign objects to mix with the Traction Fluid.**

(1)Cut the Hose 8mm to 1000mm and 1350mm.

(2)Cut the Hose 10mm to 250mm and 650mm.

**NOTE**

- When cutting the Hose 10mm, do not disconnect the hose from the oil filter as shown in the diagram on the right.

(3)Remove the rubber cap from the Traction Fluid Filter.

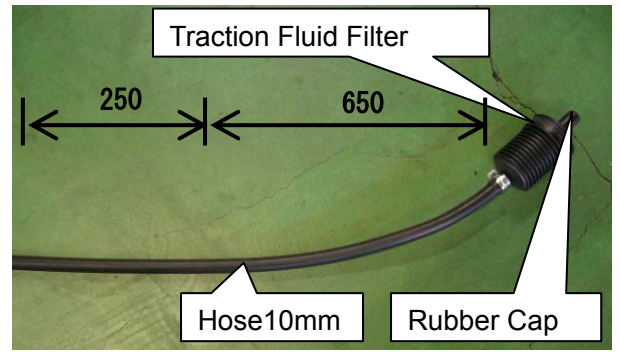

(4)Cut the Corrugated Tube 8mm to 950mm and 1300mm. Cover cut Hose 8mm with the cut Corrugated Tube.

(5)Cut the Corrugated Tube 10mm to 200mm and 600mm. Cover cut Hose 10mm with the cut Corrugated Tube.

(6)Connect the cut Hose 10mm to the other side of  
② Traction Fluid Filter using ①10mm Hose Clamp.

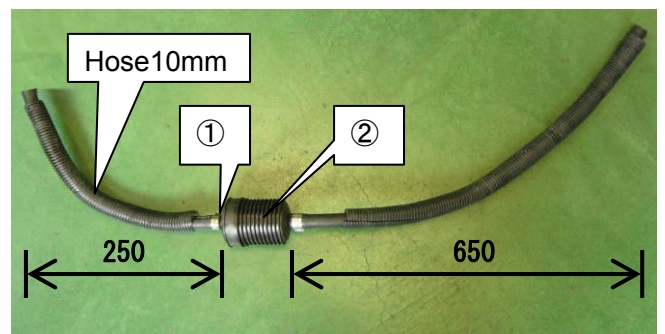

(7)Install the Traction Fluid Tank Bracket No.1 to ③Traction Fluid Tank using ①Silicon Hose 70mm L=20 and ②Hose Clamp #40

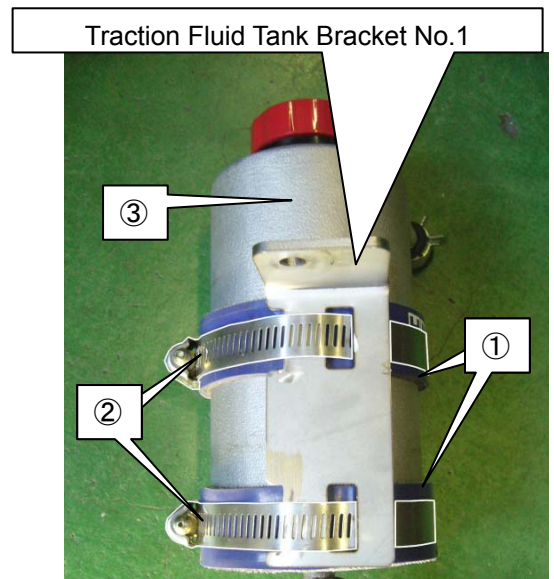



(8) Remove the rubber cap from the hose fitting on the lower part of the Traction Fluid Tank and connect ②Hose 10mm using ①Hose Clip 10mm.

(9) Install ③Silicone Hose 55mm L=43 to the Traction Fluid Filter.

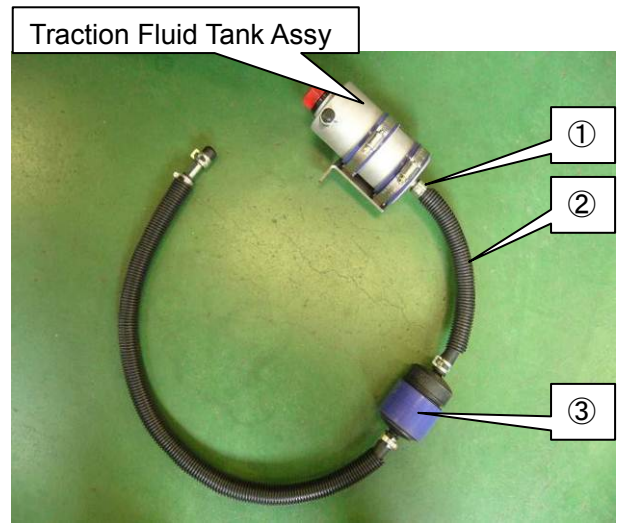

(10) Install the Traction Fluid Tank assembly to the vehicle using the following provided parts.

- ①Traction Fluid Tank Bracket No.2
- ②Hexagon Bolt M6 L=15
- ③Large Diameter Washer M6
- ④Flange Nut M6

**NOTE**

• Make sure that the longer side of the Traction Fluid Tank Bracket No.2 faces downward when installing it to the vehicle.

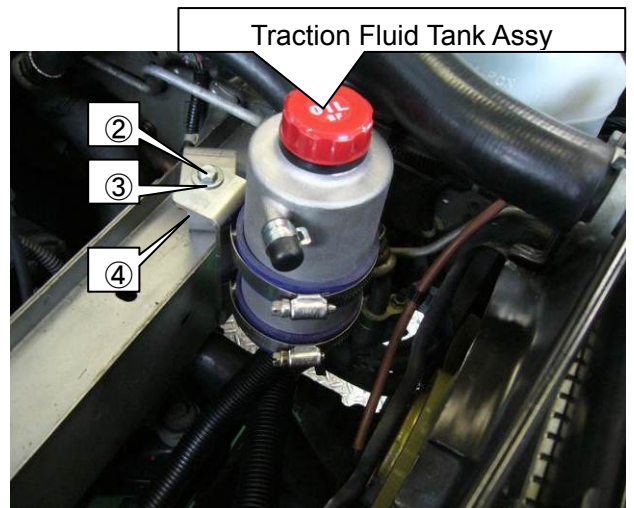
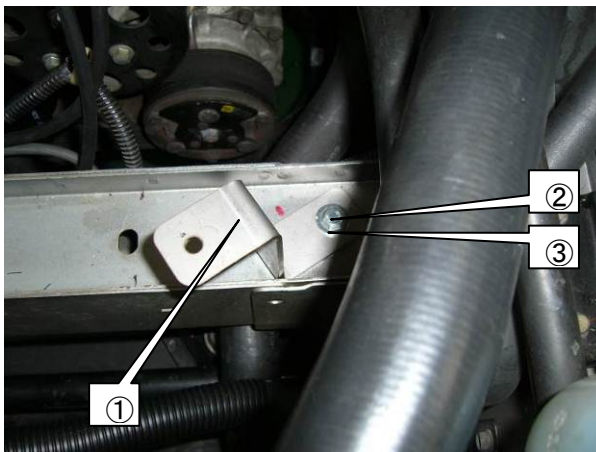

(11) Install the assembled Hose 8mm to the Traction Fluid Cooler using ①Hose Clip 8mm.

**NOTE**

• Install the 1350mm Hose 8mm Assy to the attachment on the left side and the 1000mm Hose 8mm Assy to the right side.

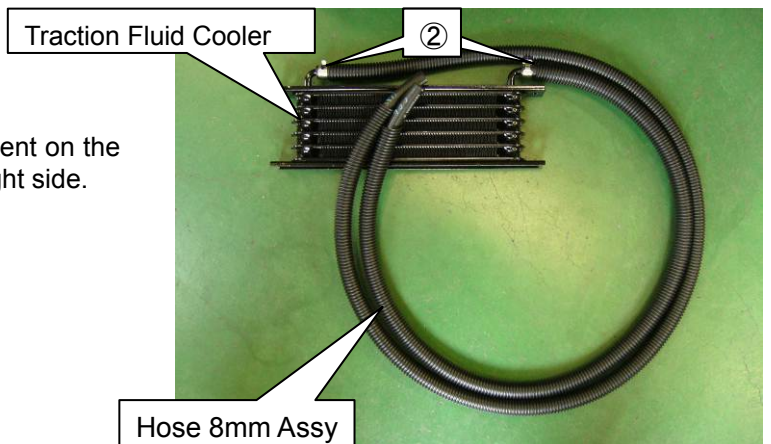

(12) Install ④Traction Fluid Cooler Bracket No.1, ⑤Traction Fluid Cooler Bracket No.2, and ⑥Traction Fluid Cooler Bracket No.3 to the Traction Fluid Cooler Assembly using ①Hexagon Bolt M8 L=15, ②Large Dia. Washer M8, and ③Flange Nut M8.

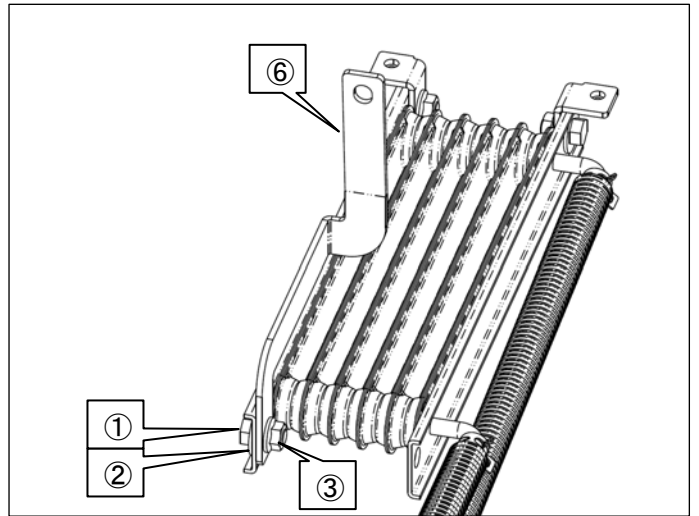
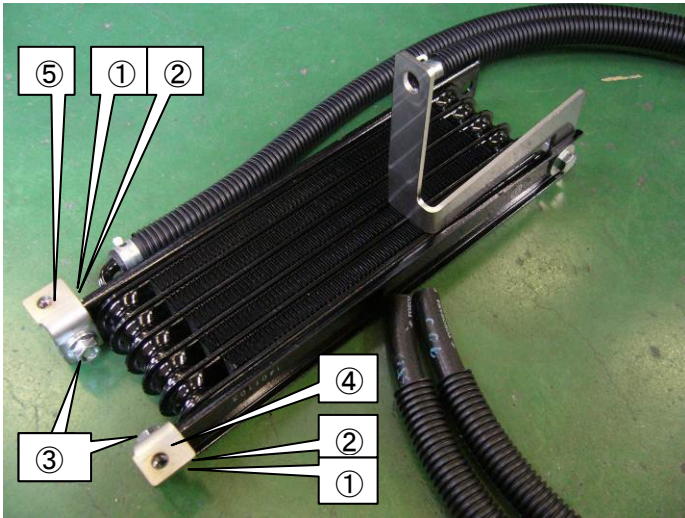

(13) Remove the A/C receiver tank from the vehicle. Modify the bracket as shown in the diagram on the right, and reinstall the A/C receiver tank to the vehicle.

※(14) This procedure is required only for a USDM vehicle.

(14) Remove the horn from the vehicle. Reinstall the removed Horn as shown in the diagram below using the following provided parts.

- ①Hexagon Bolt M8 L=20
- ②Washer M8
- ③Spacer M8 L=10



**NOTE**

- Make sure the horn works properly after reinstallation.



(15) Cut off the shaded area of the front air guide on both sides.

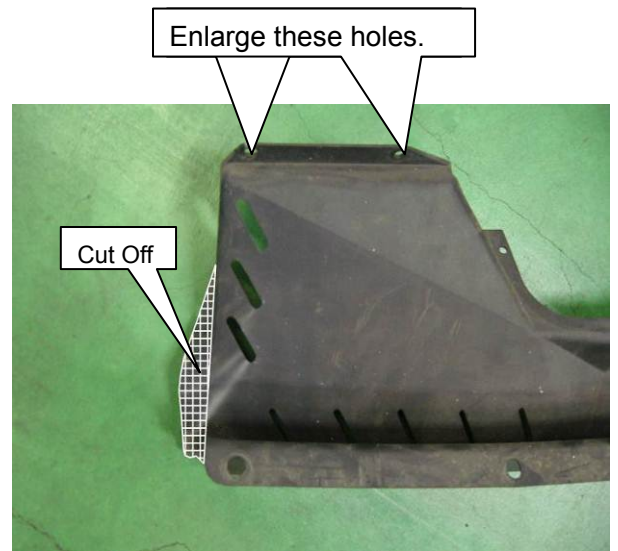

(16) Enlarge two holes on the front air guide to 11mm. (See the diagram on the right.)

(17) Place the front air guides in front of the radiator core support as shown in the diagram on the right.



(18) Install the Traction Fluid Cooler Assembly to the vehicle using the following provided parts.

- ① Hexagon Bolt M6 L=25
- ② Large Diameter Washer M6
- ③ Spacer M6 L=4

**NOTE**

• If the hole position of the Traction Fluid Cooler Bracket does not align with the hole position on the vehicle, insert the provided Large Diameter Washer M8 between the Traction Fluid Bracket No.2 and Traction Fluid Cooler to adjust the hole position.

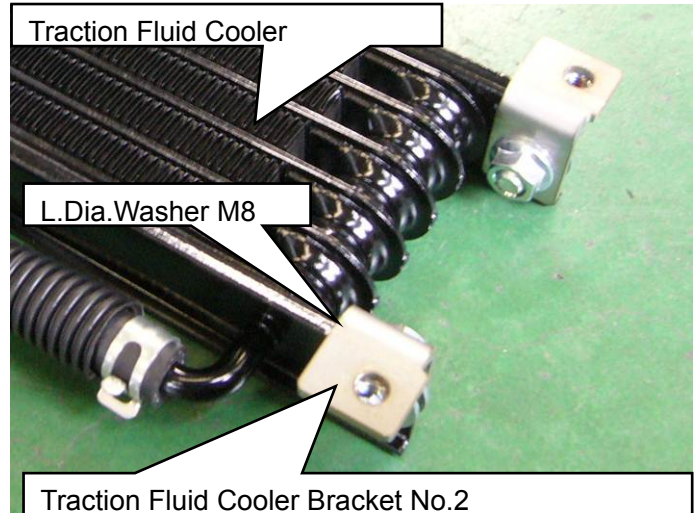
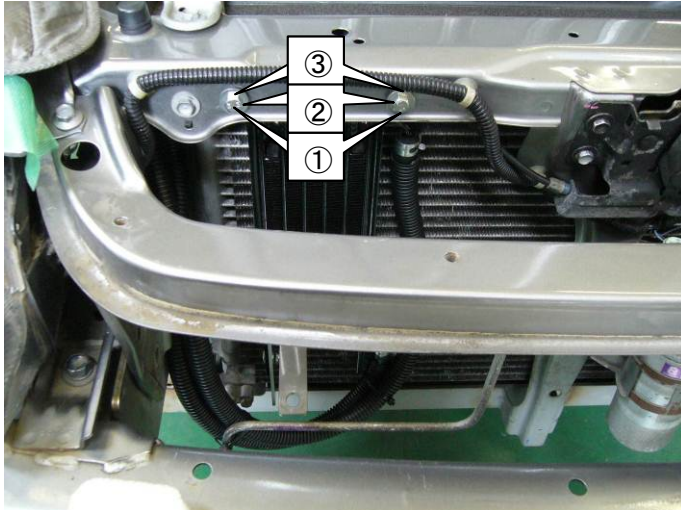

(19) Route the Hose 8mm of the Traction Fluid Cooler Assembly from the side of the radiator to the engine compartment.

(20) Connect the 1350mm long Hose 8mm to the Traction Fluid Tank using ① Hose Clamp 8mm.

(21) Secure the Hose 8mm with 2 positions as shown below using ② Tie Wrap (L).

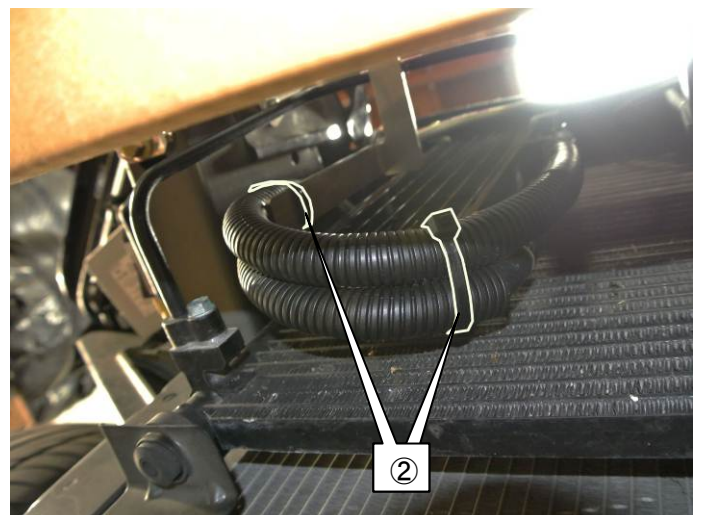
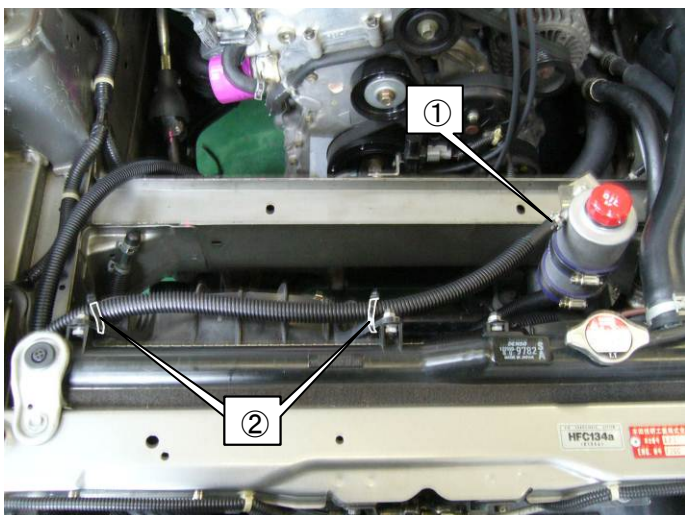

### 3. INSTALLATION OF SUPERCHARGER

#### PARTS LIST

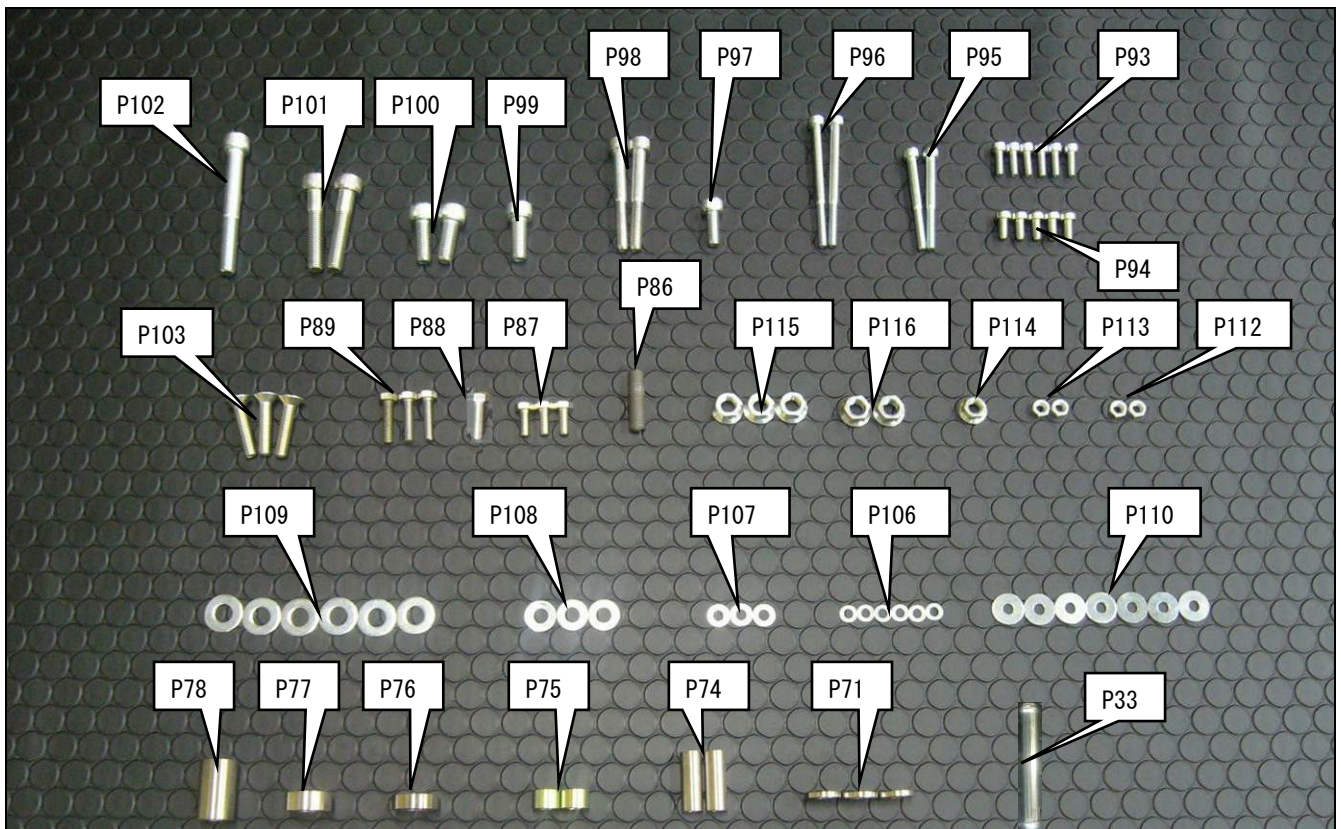
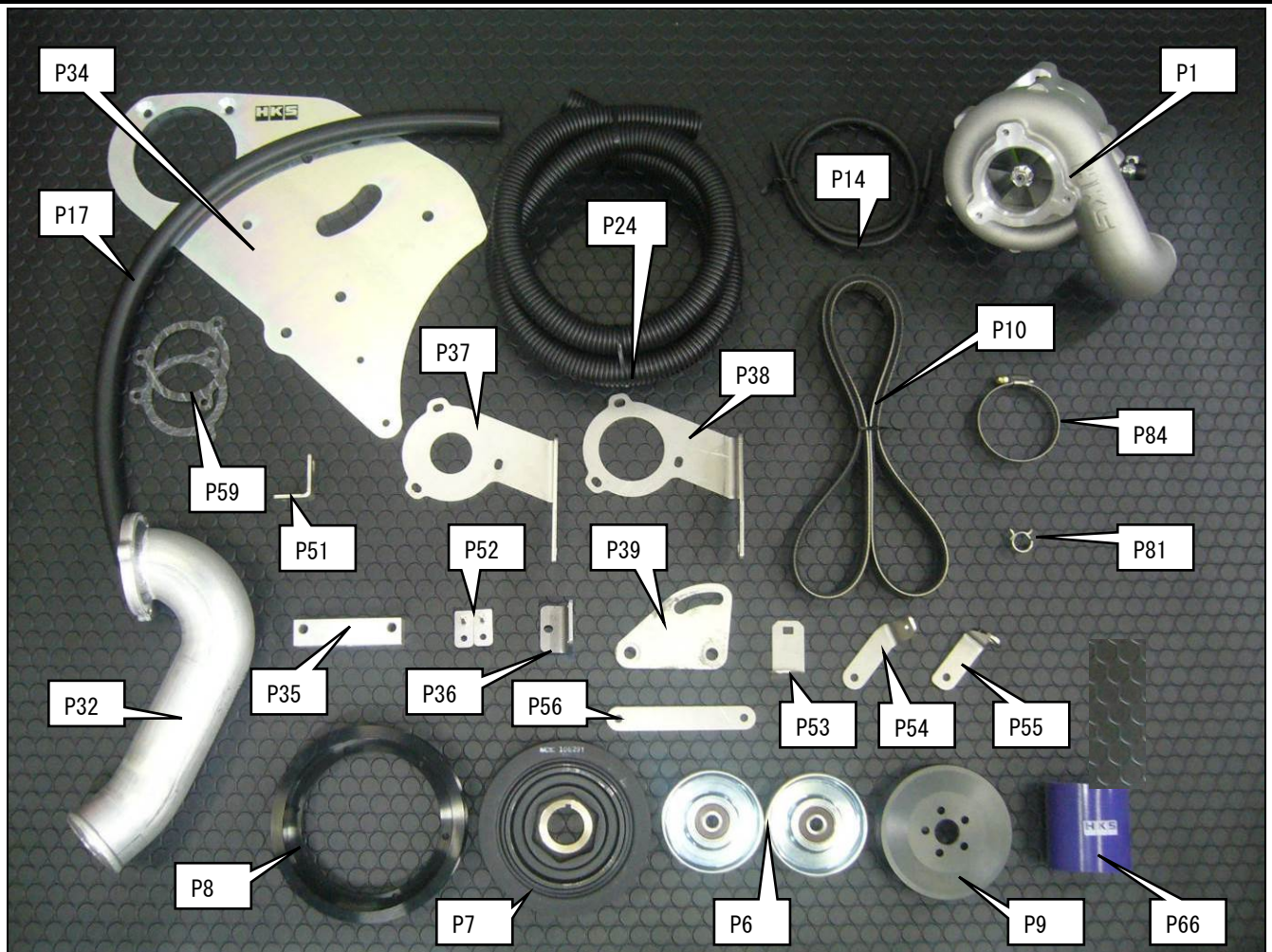

NO.	DESCRIPTION	QT
P1	Supercharger Unit	1
P6	Idler Pulley	2
P7	Crank Pulley	1
P8	S/C Crank Pulley	1
P9	Supercharger Unit Pulley	1
P10	Belt	1
P13	Air Cleaner	1
P14	Hose 4mm	1
P17	Hose 12mm	1
P24	Corrugated Tube 12mm	1
P32	Suction Pipe No.2	1
P33	Joint Pipe 8mm	1
P34	Supercharger Bracket No.1	1
P35	Supercharger Bracket No.2	1
P36	Supercharger Bracket No.3	1
P37	Supercharger Bracket No.4 (Restrictor:φ37.5)	1
P38	Supercharger Bracket No.4 (Restrictor:φ58)	1
P39	Tensioner Bracket	1
P51	Secondary Air Control SOL.V. Bracket	1
P52	ABS Modulator Bracket	2
P53	Relay Box Bracket No.1	1
P54	Relay Box Bracket No.2	1
P55	Relay Box Bracket No.3	1
P56	Horn Bracket	1
P59	Suction Pipe Gasket	2
P66	Silicone Hose 60mm L=70	1
P71	Spacer M6 L=3	3
P74	Spacer M6 L=32	2
P75	Spacer M8 L=10	2
P76	Spacer M10 L=7.5	1
P77	Spacer M10 L=10	1
P78	Spacer M10 L=32	1
P81	Hose Clip 12mm	1
P84	Hose Clamp #36	1
P86	Stud Bolt M10 10-6-20	1
P87	Hexagon Bolt M6 L=15	3
P88	Hexagon Bolt M6 L=20	1
P89	Hexagon Bolt M6 L=25	3
P93	Cap Bolt M5 L=15	6

P94	Cap Bolt M6 L=12	5
P95	Cap Bolt M6 L=60	2
P96	Cap Bolt M6 L=80	2
P97	Cap Bolt M8 L=20	1
P98	Cap Bolt M8 L=65	2
P99	Cap Bolt M10 L=25(P=1.5)	1
P100	Cap Bolt M10 L=25(P=1.25)	2
P101	Cap Bolt M10 L=50	2
P102	Cap Bolt M10 L=80	1
P103	Dish Bolt M8 L=35	3
P106	Washer M5	6
P107	Washer M6	3
P108	Washer M8	3
P109	Washer M10	6
P110	Large Diameter Washer M6	7
P112	Nut M6	2
P113	Flange Nut M6	2
P114	Flange Nut M8	1
P115	Flange Nut M10 Serrated	3
P116	Flange Nut M10 Not Serrated	2

(1) Make sure the supercharger unit's compressor housing is angled as shown in the diagram on the right.

**NOTE**

- Insert a tool into the compressor housing fixture bolt for easier measurement.

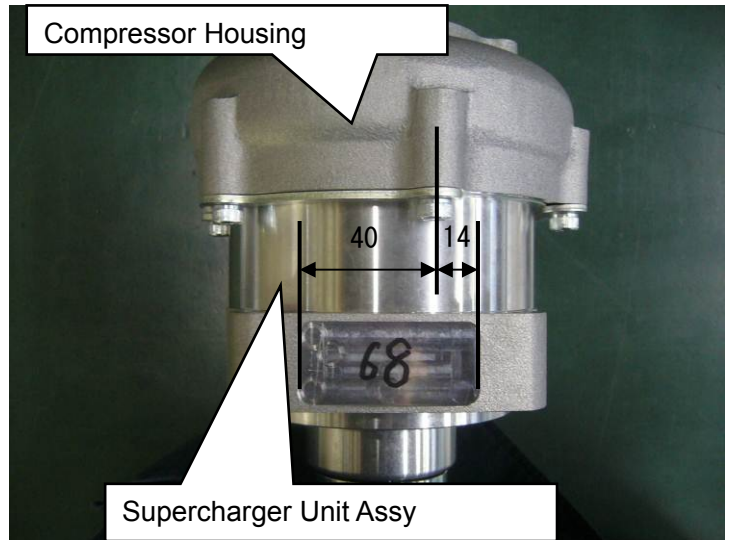

(2) Install six Supercharger Crank Pulley to the crank pulley using ① Cap Bolt M5 L=15 and ② Washer M5 as shown in the diagram on the right.

**NOTE**

- Make sure the Supercharger Crank Pulley' side with deeper groove faces toward the vehicle's front.

**Tightening Torque N·m(kgf·m)**

$T=10(1.0)$

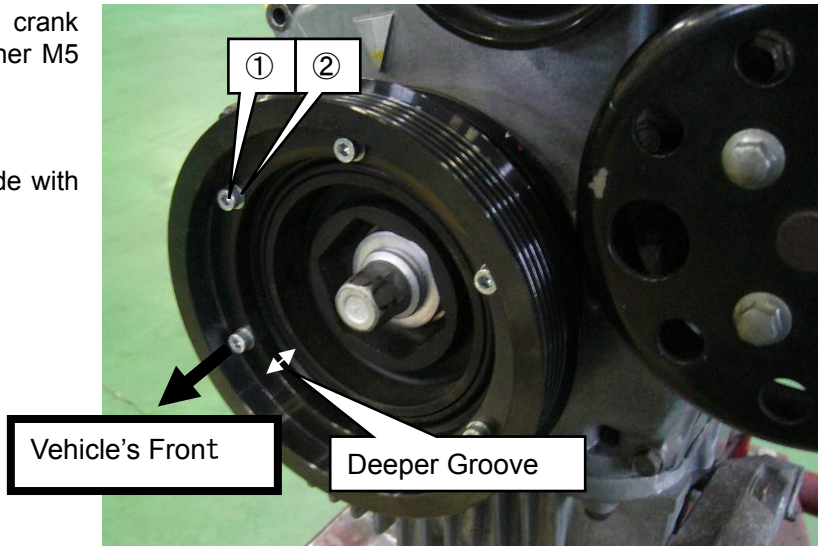

(3) Remove bolts ①②③④⑤⑥⑦ in the diagram below.

(4) Adjust the hose angle so the tab of Hose Clip⑧ becomes in upward direction.

(5) Remove the coupler bracket as shown in the diagram below.

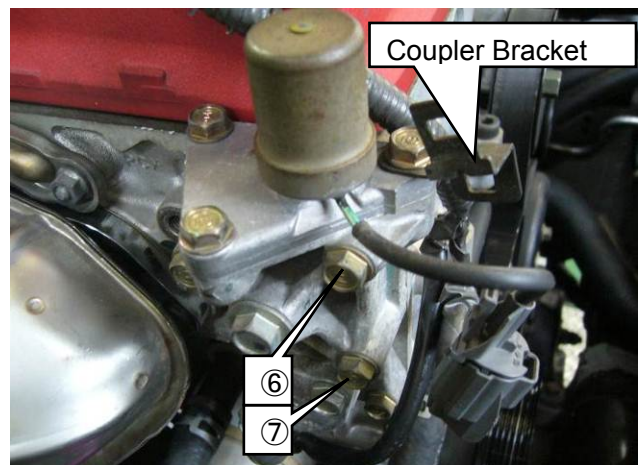
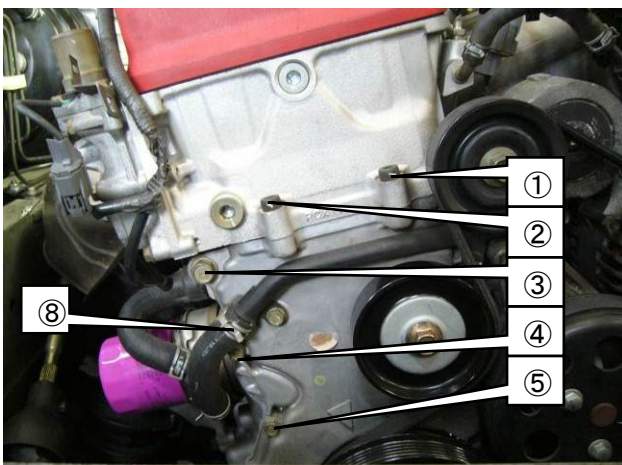



(6) Install the Idler Bracket to the Supercharger Bracket No.1 using ①Cap Bolt M10 L=50, ②Washer M10, ③Spacer M10 L=10, and ④Flange Nut M10.

**NOTE**

- Make sure the Idler Pulley' side with a C-ring faces toward the Supercharger Bracket No.1.

Tightening Torque N·m(kgf·m)

$$T=44(4.5)$$

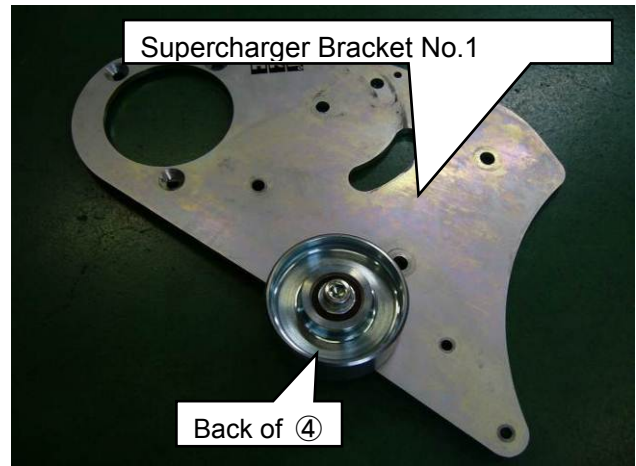
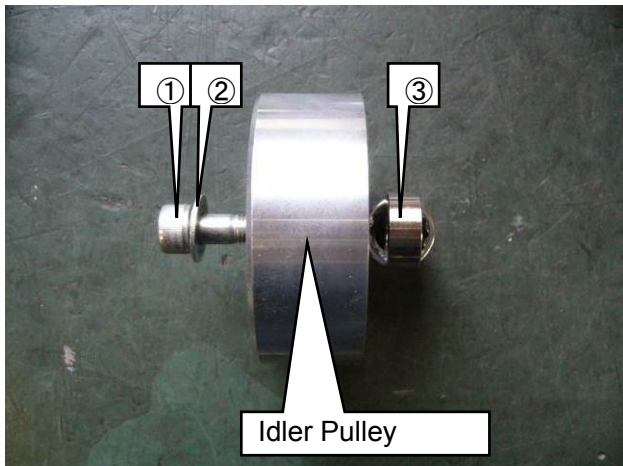

(7) Install the Idler Pulley to the Tensioner Bracket using ①Cap Bolt M10 L=50, ②Washer M10, ③Spacer M10 L=7.5, and ④Flange Nut M10.

**NOTE**

- Make sure the Idler Pulley' side with a C-ring faces toward the Tensioner Bracket.

Tightening Torque N·m(kgf·m)

$$T=44(4.5)$$

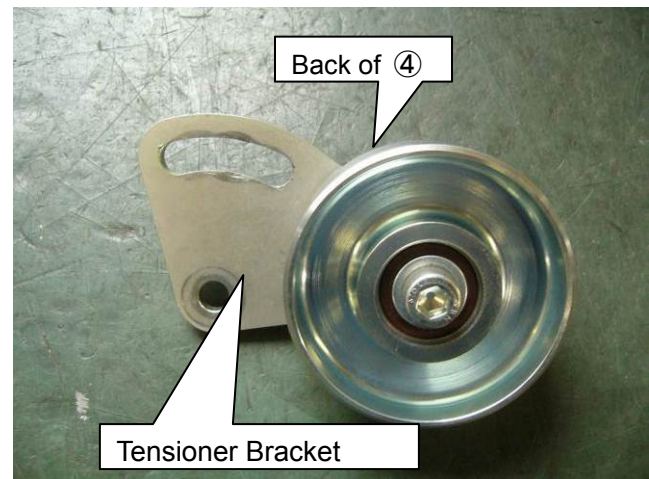
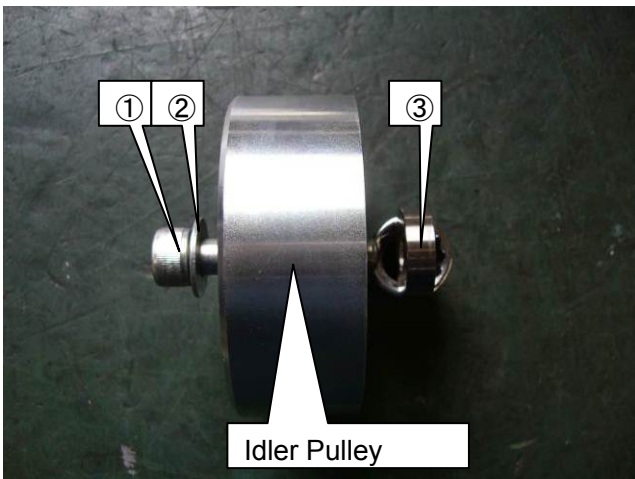

(8) Temporarily install the Supercharger Bracket No.2 to the engine using ①Cap Bolt M8 L=65, ②Washer M8, and ③Spacer M8 L=10.

**NOTE**

• Make sure the Supercharger Bracket No.2 was installed as shown in the diagrams below.

Final Tightening Torque N·m(kgf·m)  
T=24(2.45)

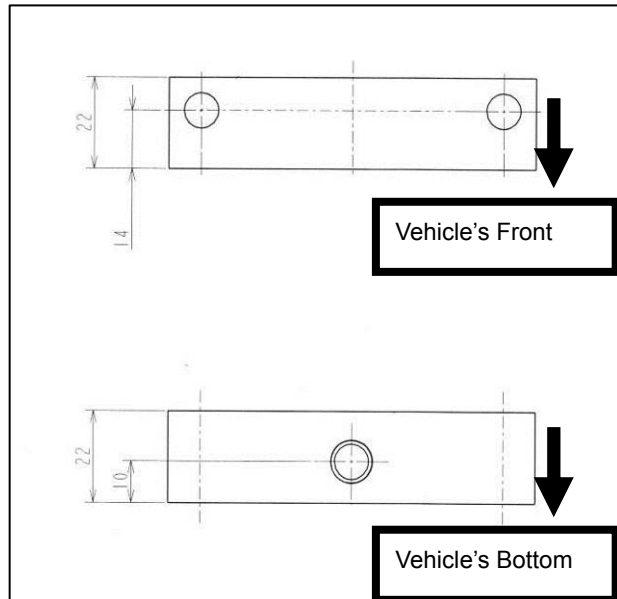
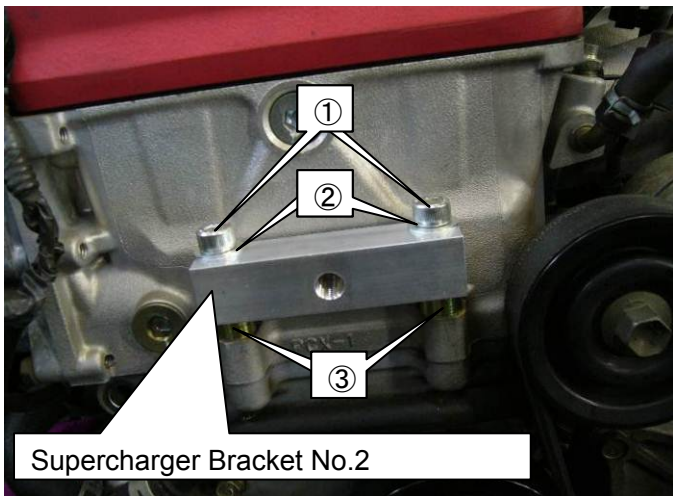

(9) Temporarily install the Supercharger Bracket No.3 to the spool solenoid valve using ①Cap Bolt M6 L=60 and ②Large Diameter Washer M6.

Final Tightening Torque N·m(kgf·m)  
T=15(1.5)

(10) Secure the coupler to the Supercharger Bracket No.3 using ③Tie Wrap (L).

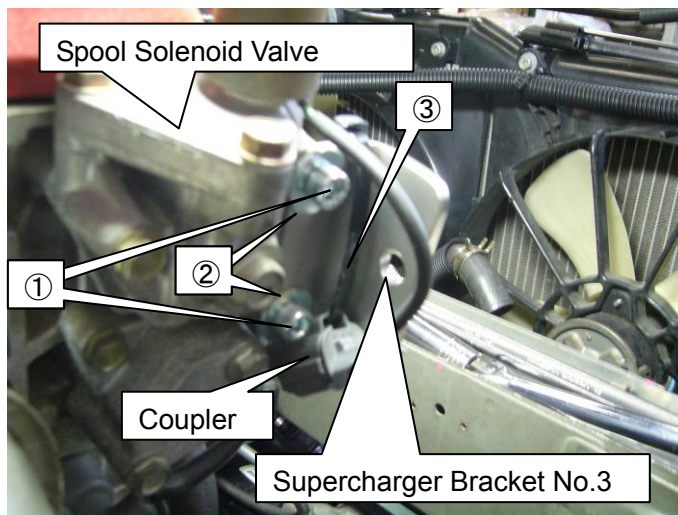

※(11)~(26) This procedure is required only for a USDM vehicle.

(11) Remove the factory horn coupler from the factory horn. Remove the factory horn assembly with the horn bracket from the vehicle.

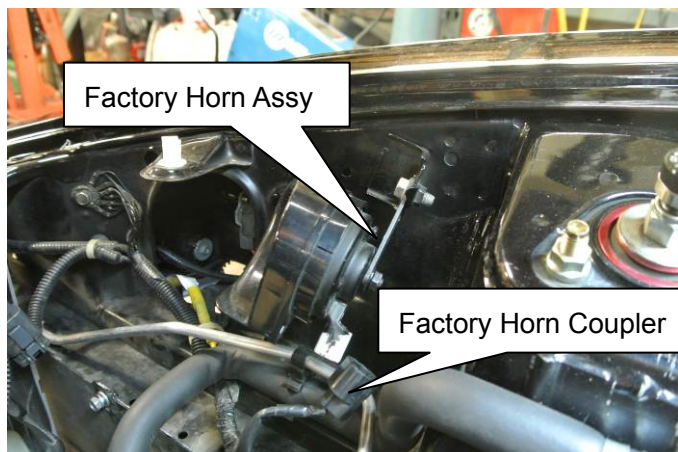

(12) Loosen the factory bolt on the center of the horn. Replace the factory horn bracket with the provided Horn Bracket using the factory bolt.

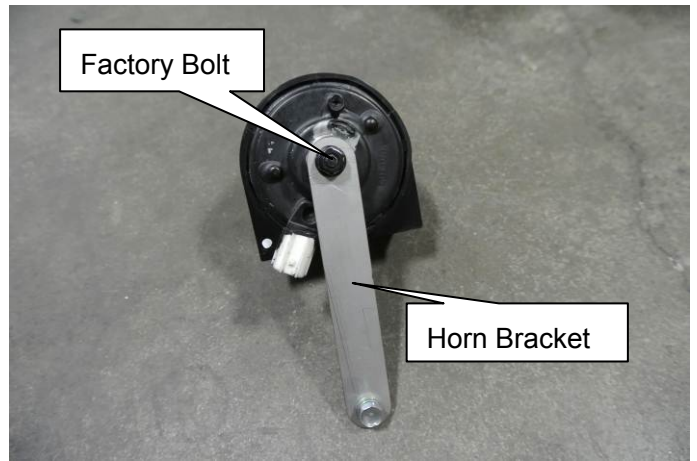

(13) Install the factory horn assembly to the vehicle using ① factory air cleaner assembly bracket fixing bolt.

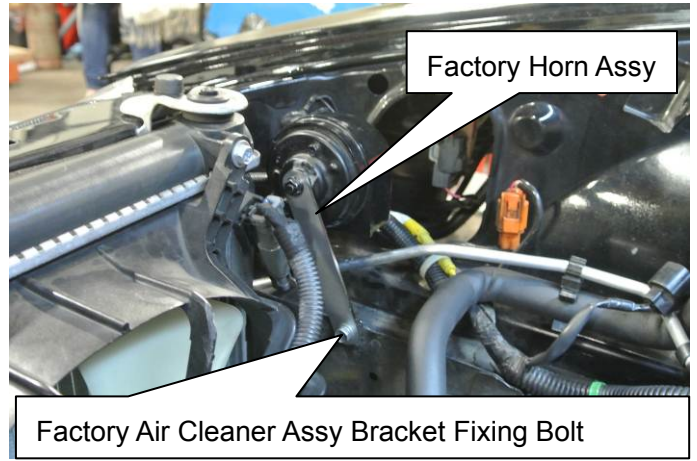

(14) Remove the vinyl tape from the factory horn coupler's end and install the factory horn coupler to the factory horn that was relocated.

**NOTE**

- Wrap the factory horn coupler's end with a vinyl tape after installing the coupler.

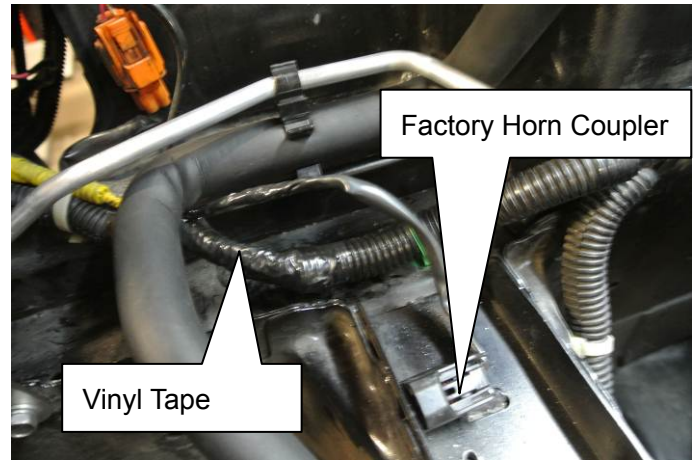

(15) Remove the battery to relocate the relay box.

(16) Replace the battery with a generic racing battery or locate the battery using a necessary tool.

(17) Remove the relay box.

**NOTE**

- The factory relay box installation bolt will be reused later.

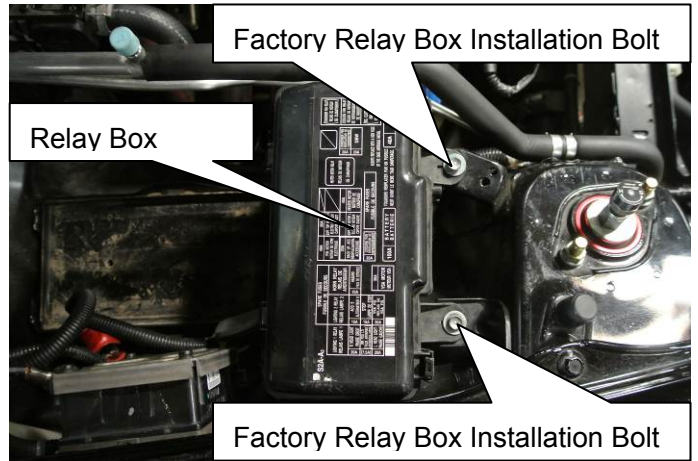

(18) Install ①Relay Box Bracket No.1 to the relay box.

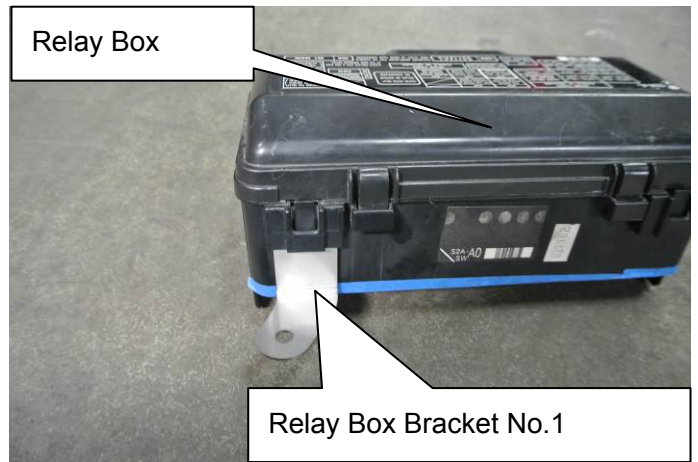

(19) ①Relay Box Bracket No.2 and ②Relay Box Bracket No.3 to the relay box assembly using ③factory relay box installation bolt and ④Flange Nut M6.

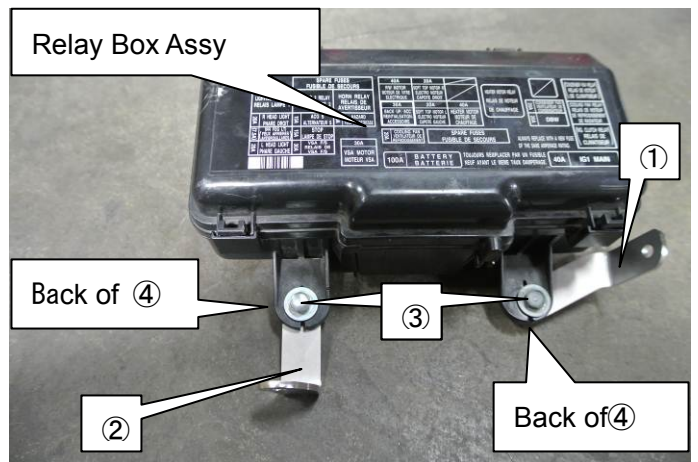

(20) Remove ①factory relay box bracket installation bolt; then, remove the factory relay box bracket from the vehicle.

**NOTE**

- ①factory relay box bracket installation bolt will be reused later.

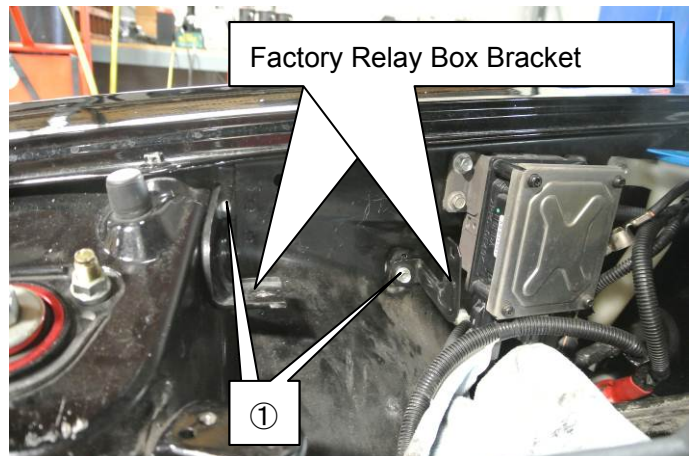

- (21) Install the relay box assembly to the vehicle using  
①factory relay box bracket fixing bolt.

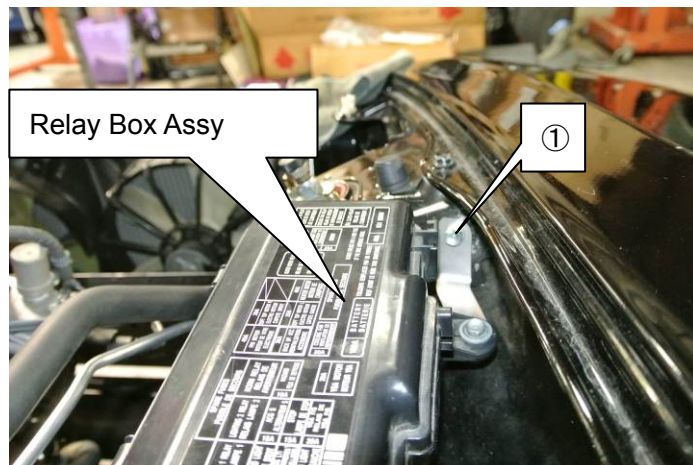

- (22) Remove ①factory EPS control unit fixing bolt. Install the relay box assembly to the vehicle using ②Relay Box Bracket No.3 and ①.

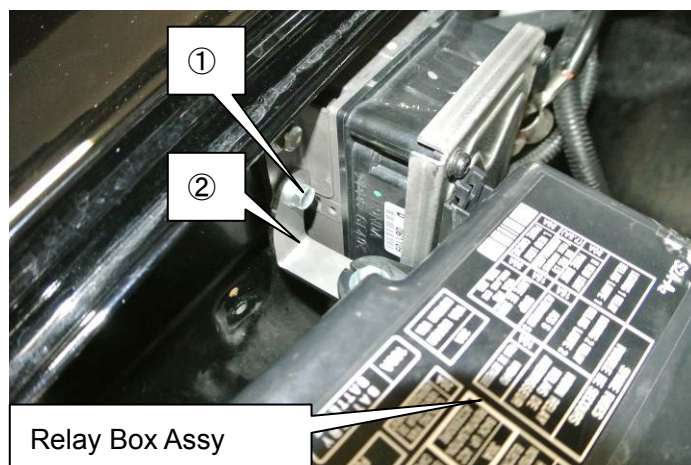

- (23) Install the relay box assembly to the vehicle using  
①factory relay box bracket fixing bolt.



(24) Remove the clamp from the thick A/C pipe.

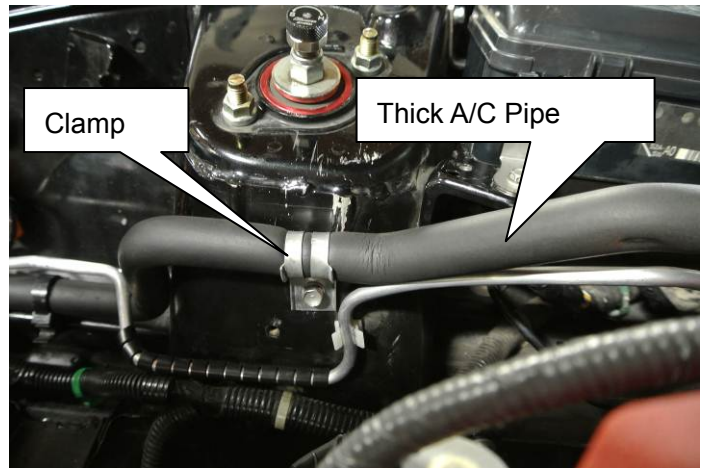

(25) Bend the thick A/C pipe to avoid unnecessary contact with the Supercharger unit and other parts.

- Lift the portion ② in the direction of the arrow and bend the pipe from the point ① so the pipe comes over the strut tower.

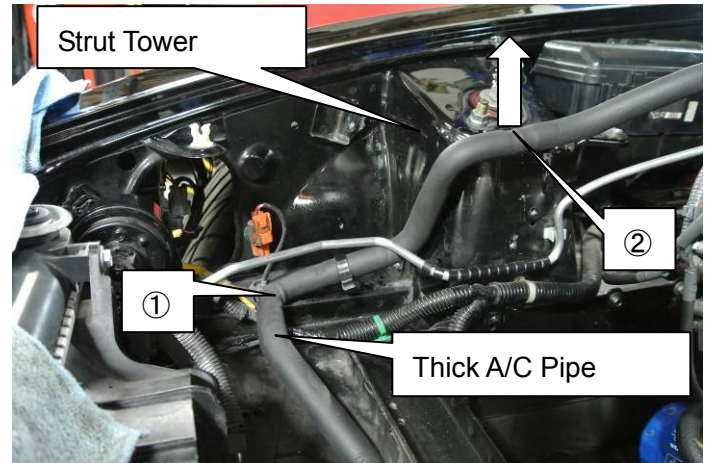

(26) Keep an adequate space to avoid unnecessary contact with the Supercharger unit.

- Bend both thick and thin A/C pipes in the direction of the arrow shown in the diagrams below to make a shaded space shown in the diagrams. Make sure both A/C pipes do not come in contact with any other parts of the vehicle.

**NOTE**

- Insulate the A/C pipes and the heater hose if necessary.

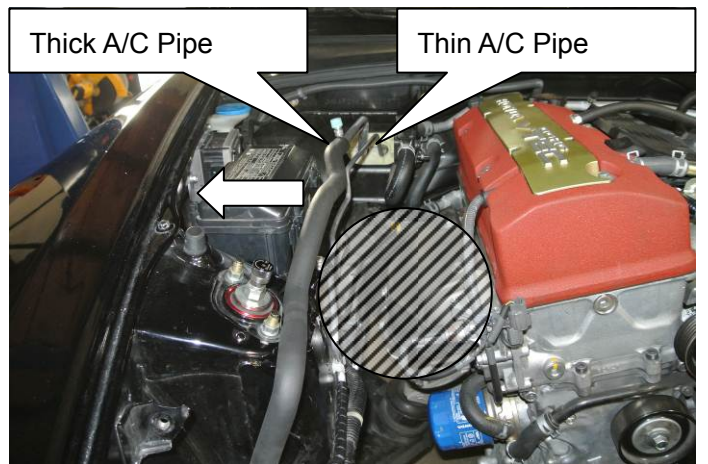
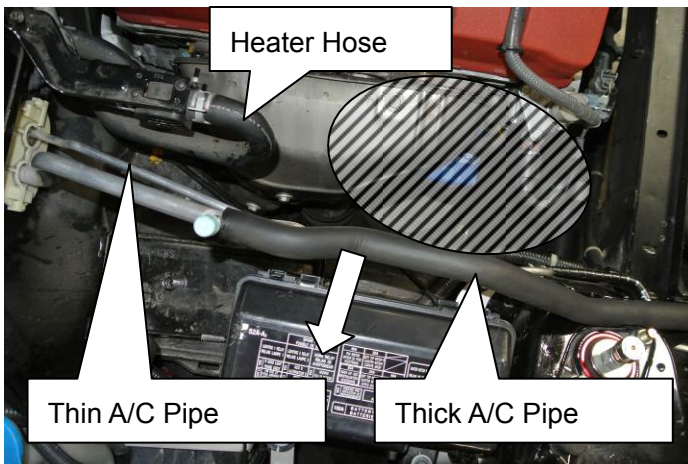

(27) Temporarily install the assembled Supercharger Bracket No.1 to the engine using the following provided parts:

- ① Cap Bolt M10 L=80
- ② Cap Bolt M6 L=80
- ③ Washer M10
- ④ Large Diameter Washer M6
- ⑤ Spacer M10 L=32
- ⑥ Spacer M6 L=32

**Final Tightening Torque N·m(kgf·m)**

- M10 T=44(4.5)
- M6 T=15(1.5)

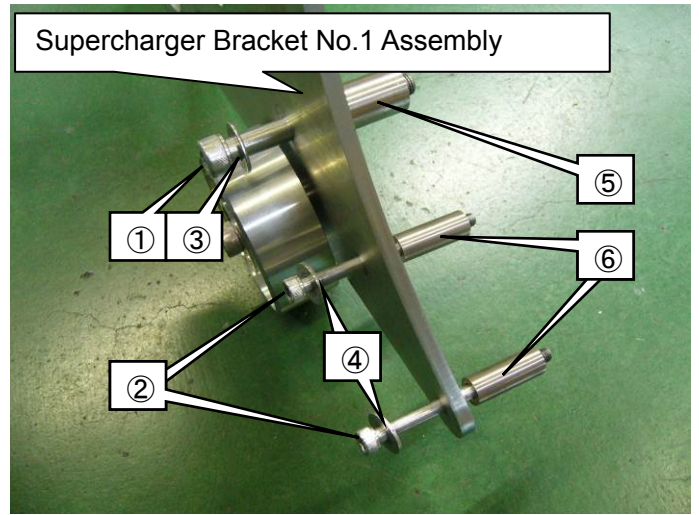

(28) Temporarily install the assembled Supercharger Bracket No.1 to the Supercharger Bracket No.2 using ⑦ Cap Bolt M10 L=25 (P1.5) and ⑧ Washer M10.

**Final Tightening Torque N·m(kgf·m)**

- T=44(4.5)

(29) Temporarily install the assembled Supercharger Bracket No.1 to the Supercharger Bracket No.3 using ⑨ Cap Bolt M8 L=20, ⑩ Washer M8, and ⑪ Flange Nut M8.

**Final Tightening Torque N·m(kgf·m)**

- T=24(2.45)

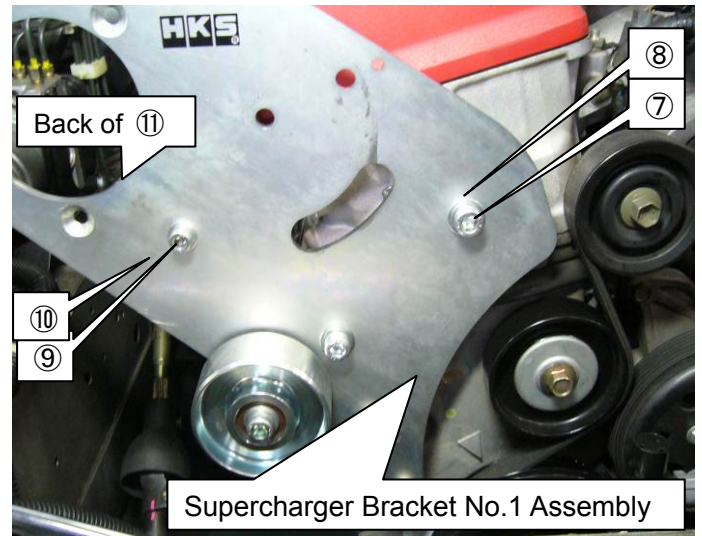

(30) Tighten the Supercharger Bracket No.1, No.2, and No.3 to the final tightening torque. Make sure to tighten them properly.

※(31)~(34) This procedure is required only for a vehicle with the wire throttle control system.

(31) Install the 2nd Air Control SOL. V. Bracket to the secondary air control solenoid valve.

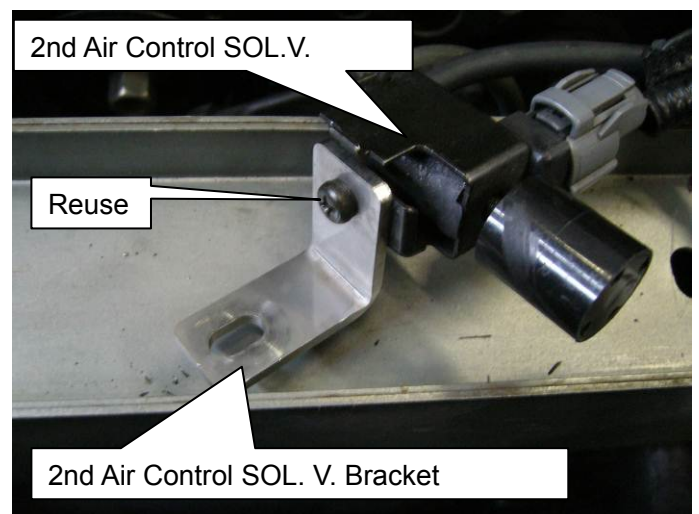

(32) Remove the 2nd air control SOL.V. vacuum tank from the vehicle.

(33) Cut the Hose 4mm to 500mm in length. Connect the cut hoses to the secondary air control solenoid valve and vacuum tank as shown in the diagram on the right.

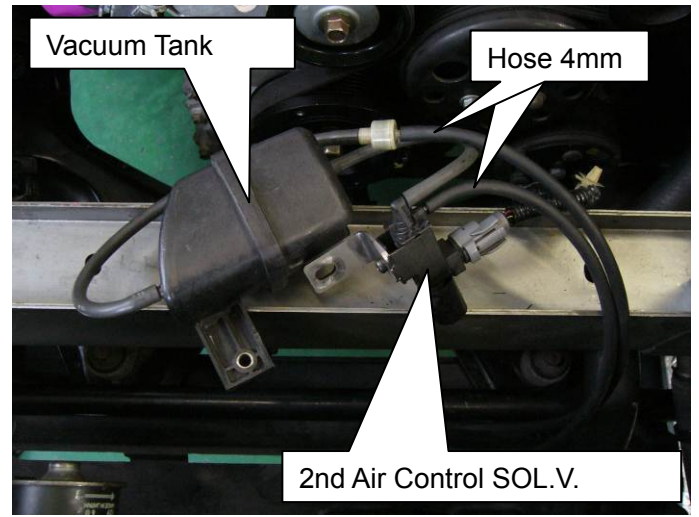

(34) Install the 2nd air control solenoid valve and vacuum tank to the vehicle using ①Hexagon Bolt M6 L=25, ②Large Diameter Washer M6, and ③Spacer M6 L=3

**NOTE**

- Make sure to secure hoses using Tie Wraps so they don't come in contact with any other rotative parts such as a crank pulley.

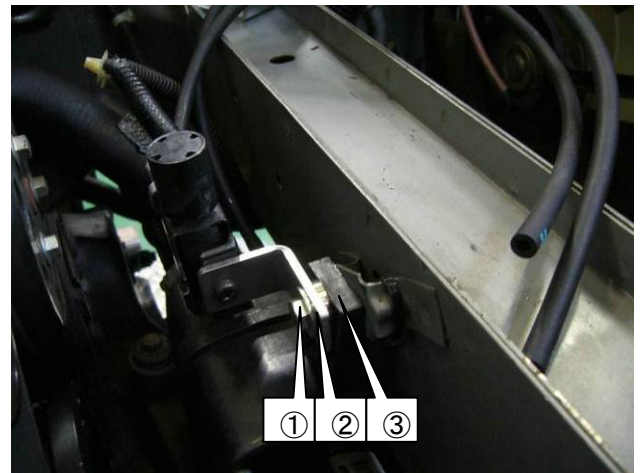

(35) Replace the breather pipe assembly with ①Joint Pipe 8mm.

**NOTE**

- Reuse the removed factory hose clip.
- Prepare a container to catch coolant leaked from the breather pipe assembly.

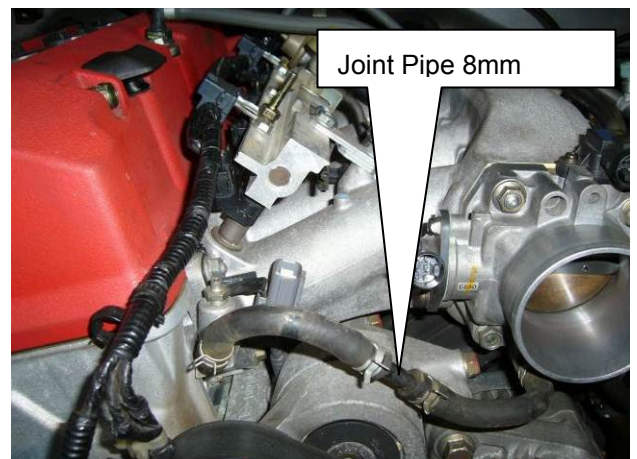
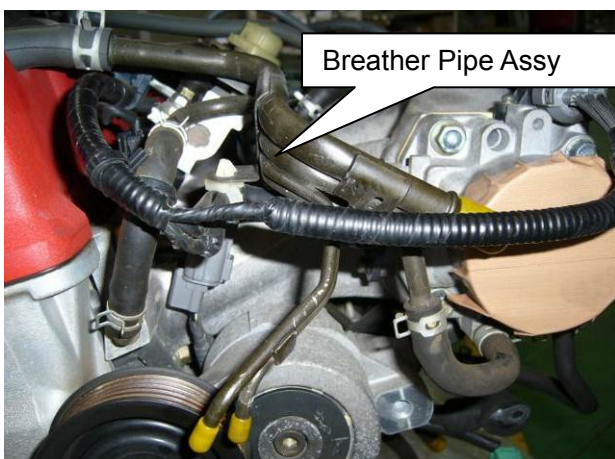



※(36) This procedure is required only for a vehicle with the wire throttle control system.

(36) Connect the Hose 4mm L=500 attached to the Secondary Air Control Solenoid Valve and vacuum tank to the engine as shown in the diagram on the right.

**NOTE**

- Connect the hose from the Secondary Air Control Solenoid Valve to the upper side of the hose from the engine and the hose from the vacuum tank to the lower side of the hose from the engine.

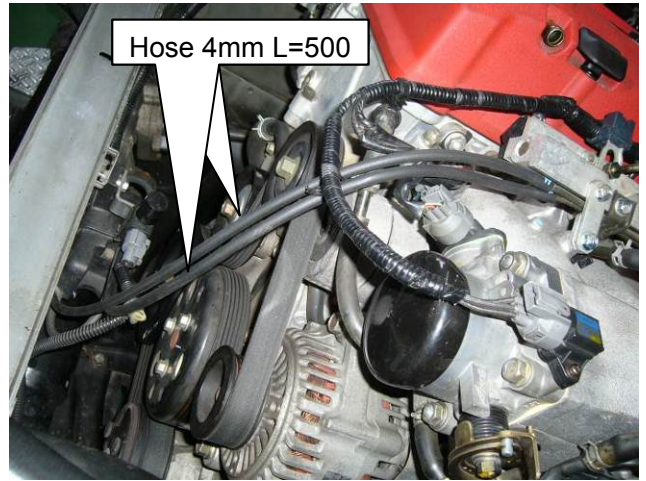

(37) Connect ①Hose 8mm L=1000 and ②Hose 10mm L=650 to the Supercharger Unit using the ③Hose Clip 8mm and ④Hose Clip 10mm removed from the Supercharger Unit.

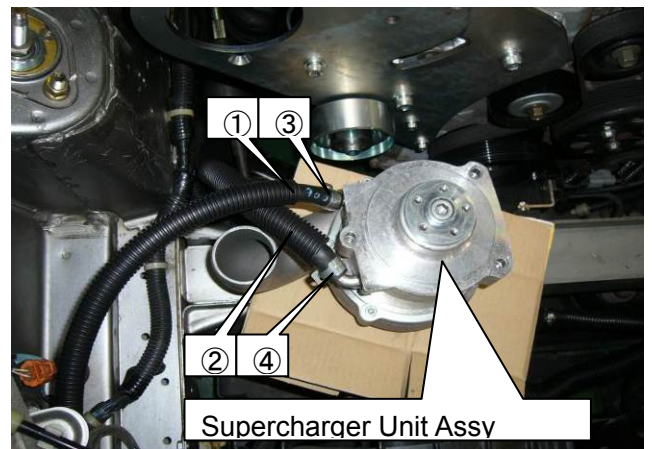

(38) Install the Supercharger Unit to the Supercharger Bracket No.1 using ①Dish Bolt M8 L=35.

**Tightening Torque N·m(kgf·m)**  
T=29(3.0)

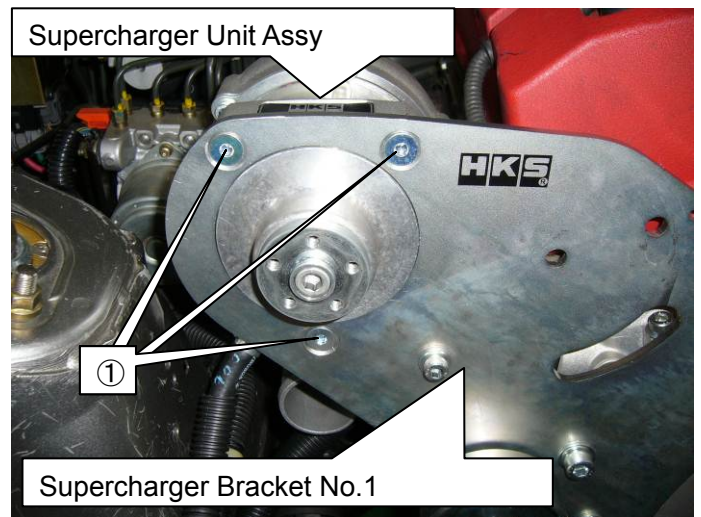

(39) Secure ①Hose 8mm L=1000 and ②Hose 10mm L=650 together using ③Tie Wrap(L).

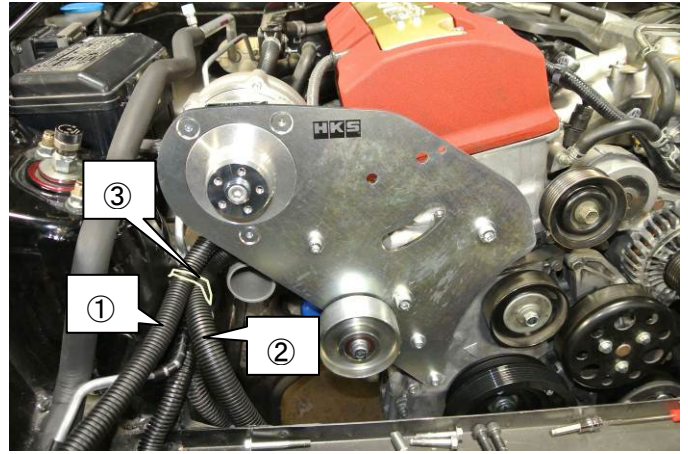

※(40)~(41)This procedure is required only for a JDM vehicle.

(40)Remove the bolts ①, ②, and ③ from the ABS Modulator Assembly.

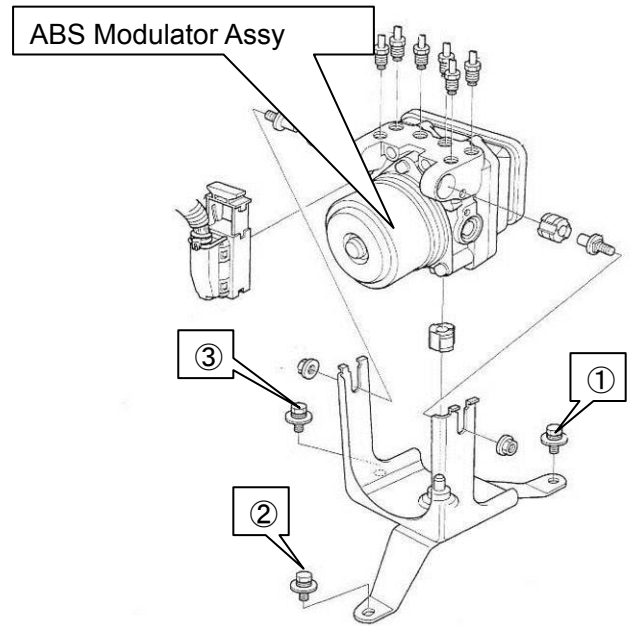

(41)Install ④ABS Modulator Bracket, ⑤Large Diameter Washer M6, ⑥Nut M6, and ⑦Spacer M6 L=3 to each position of the bolt ① and ② removed in (24) as shown in the diagram below. Reinstall the bolts ① and ② to secure them to the vehicle. Relocate the ABS Modulator Assembly to the right side of the vehicle.

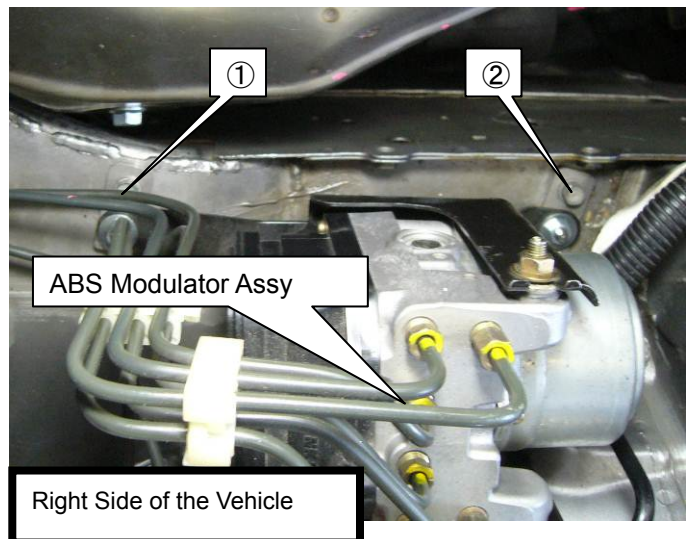
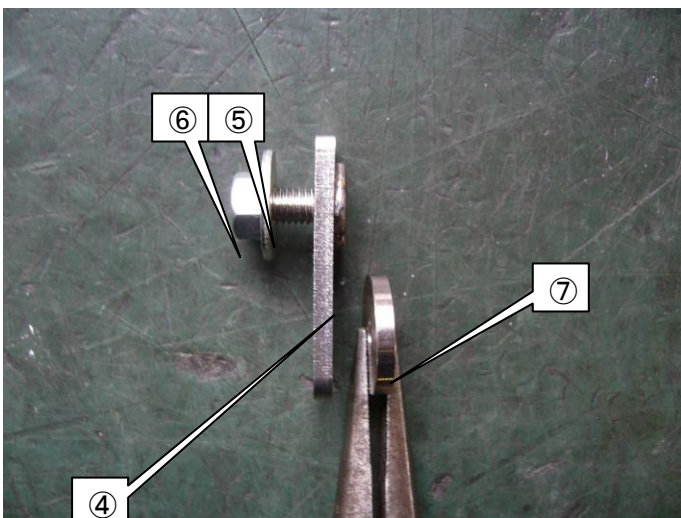

(42) Install the Supercharger Unit Pulley to the Supercharger Unit using ① Cap Bolt M6 L=12.

**NOTE**

- When tightening the bolt, hold the bolt in the center of the pulley with a hexagon wrench so the center part of the Supercharger does not rotate.

**Tightening Torque N·m(kgf·m)**

T=10(1.0)

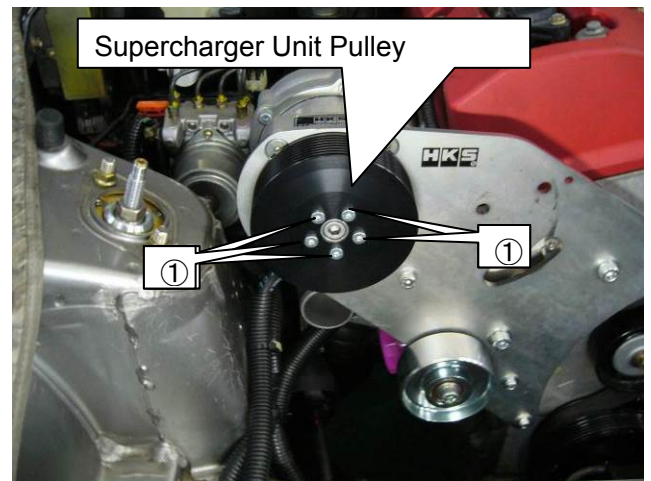

(43) Install the provided Belt as shown in the diagram on the right.

**NOTE**

- Make sure the belt is correctly aligned with the center of 8 ribs' groove on the Supercharger Unit Pulley.
- For easier installation of the Belt, warm up the Belt, or remove the Idler Pulley.

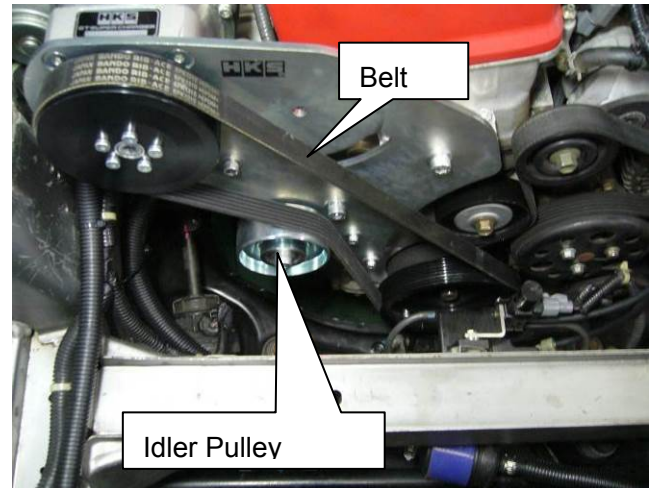

(44) Put a 2mm dent on the shaded portion of the factory exhaust manifold cover to make a clearance between the Suction Pipe No.2 and the cover.

(45) Reinstall the factory exhaust manifold cover to the vehicle.

**NOTE**

- To install the factory exhaust manifold cover to the vehicle easily, start installing the cover from the number 4 port on the vehicle's rear side; then, install the number 1 port on the vehicle's front side.



(46) Install ② Silicone Hose 60mm L=70 to the Suction Pipe No.2 using ① Hose Clamp #36.

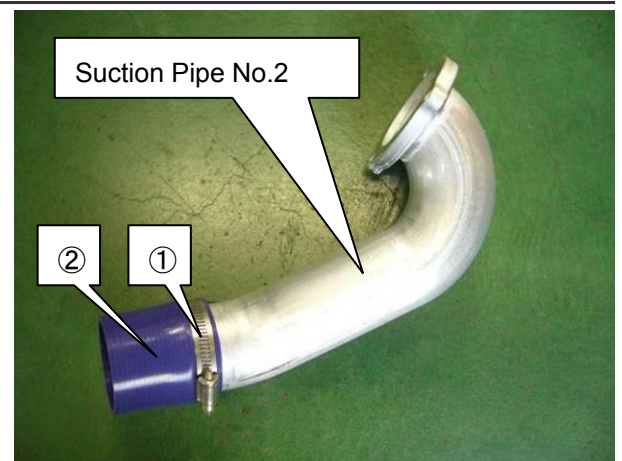

(47)Install ①Stud Bolt to the engine.

**NOTE**

- Make sure to install the Stud Bolt in proper direction. Install the shorter thread side to the engine.

(48)Temporarily install the Supercharger Bracket No.4 to the Supercharger Unit using ②Suction Pipe Gasket, ③Hexagon Bolt M6 L=15, and ④Washer M6.

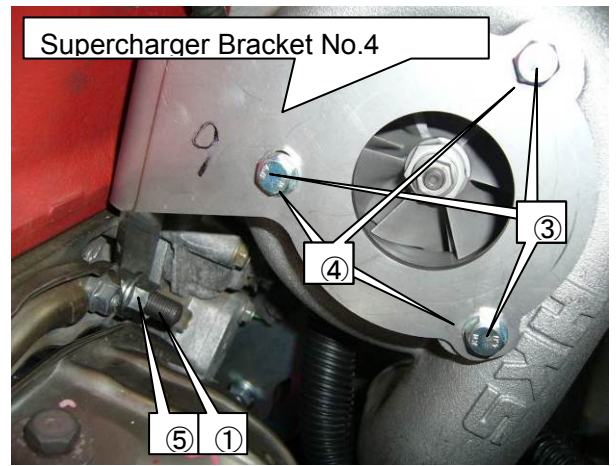

**NOTE**

- Supercharger Bracket No. 4 works as restrictor. Select a proper item by referring to the following chart.

Specifications	Diameter of restrictor
Spec for JDM Stock fuel parts (fuel pump, injector)	φ37.5 (Included in this kit)
Spec for JDM with HKS Fuel Upgrade Kit	φ44 (Included in Fuel Upgrade Kit)
Spec for USDM Upgrade fuel parts	φ58 (Included in this kit)

※Capacity of stock fuel system of vehicles with electronic throttle is not enough for forced injection. Thus, upgrading of fuel system is required for supercharger. In order to use preprogrammed data of HKS Flash Editor, install HKS Fuel Upgrade Kit and φ44 restrictor.

**⚠ CAUTION**

•Horsepower is limited by the restrictor. Please select a proper inner diameter of restrictor for specification of the vehicle. Otherwise, unexpected horsepower may damage the engine.

(49)Install the Supercharger Bracket No.4 to the engine using ⑤Flange Nut M10 (Serrated).

(50)Remove ③Hexagon Bolt M6 L=15 and ④Washer M6 from the Supercharger Bracket No.4 temporarily installed.

**NOTE**

- Keep the removed ③Hexagon Bolt M6 L=15 and ④Washer M6 for later use.

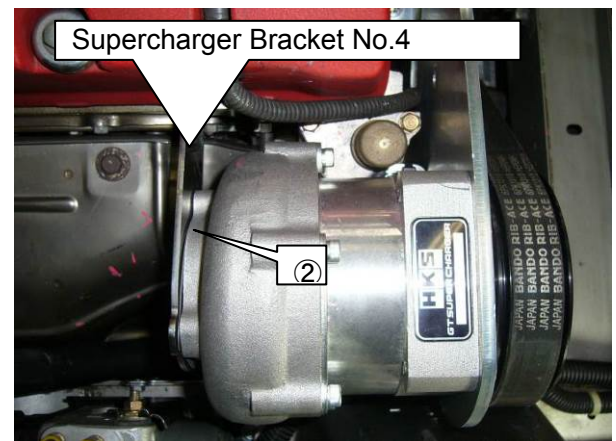

(51) Install the Suction Pipe No.2 to the Supercharger Unit using ①Hexagon Bolt M6 L=25, ②Hexagon Bolt M6 L=20, ③Washer M6, and ④Suction Pipe Gasket.

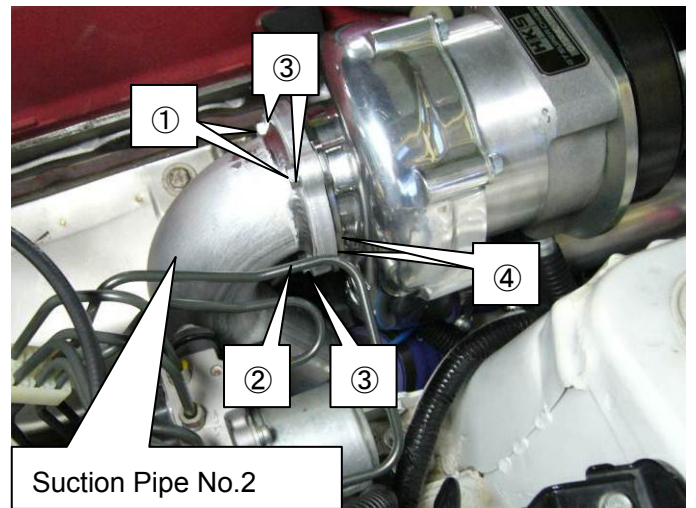

(52) Install the Tensioner Bracket assembly to the Supercharger Bracket No.1 using ①Cap Bolt M10 L=25, ②Washer M10, and ③Flange Nut M10.

(53) Move the Tensioner Bracket assembly up and down and apply the tension spec to the belt. (See the table below.)

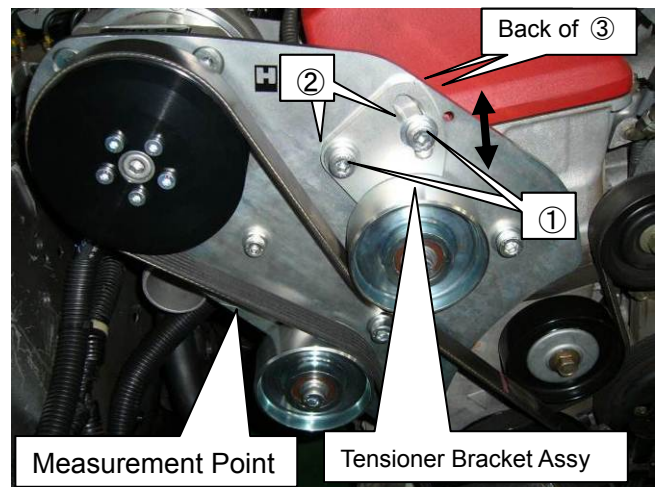

Measurement Point	Belt Span※	Designated Tension (N { kgf })
Between Supercharger Unit Pulley and Idler Pulley	200mm	720{73.4}

※Enter the belt span to the tension meter when measuring tension.

※Belt weight:14.5g/(1rib x 1m length)

**NOTE**

- Measure the belt tension when the belt is cold.
- After installing the belt, adjust the tension. Rotate the crankshaft at least twice and re-adjust the tension to the indicated spec. This is to eliminate the inconsistency of the belt tension on the pulley.
- Belt tension will settle at about 2-20 hours after installation. After the belt settles, re-measure the tension to make sure it matches the tension spec. Adjust tension as necessary. Periodically monitor belt tension to make sure it is up to specifications.
- Make sure the belt is correctly aligned with the grooves on the pulley.

**Tightening Torque N·m(kgf·m)**

T=44(4.5)

(54) Cut the Hose 12mm to 680mm in length.

(55) Install the Hose 12mm cut in (54) to the engine head cover using ①Hose Clip 12mm.

**NOTE**

- By applying lubricant to a hose clip and through the engine head cover beforehand, installation will be easier.

(56) Cut the Corrugated Tube 12mm to 630mm in length.

(57) Install the Corrugated Tube 12mm cut in (56) to the Hose 12mm.

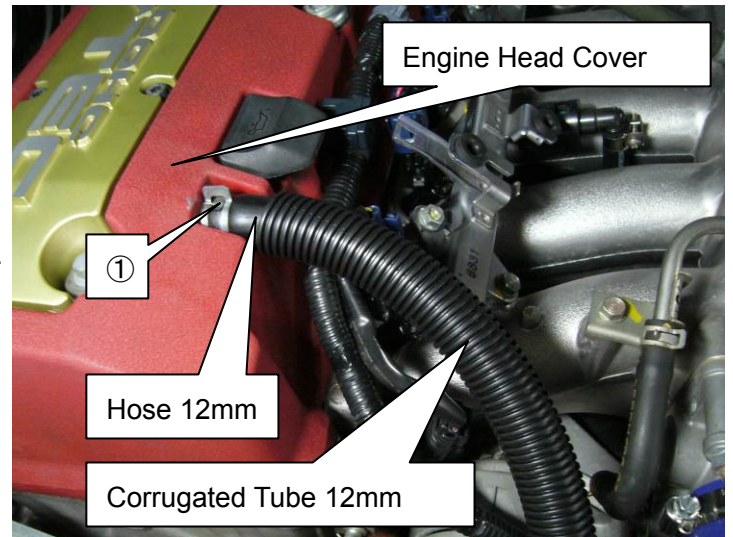

## 4. INSTALLATION OF INTERCOOLER / PIPING

### • Installation of Intercooler

#### PARTS LIST

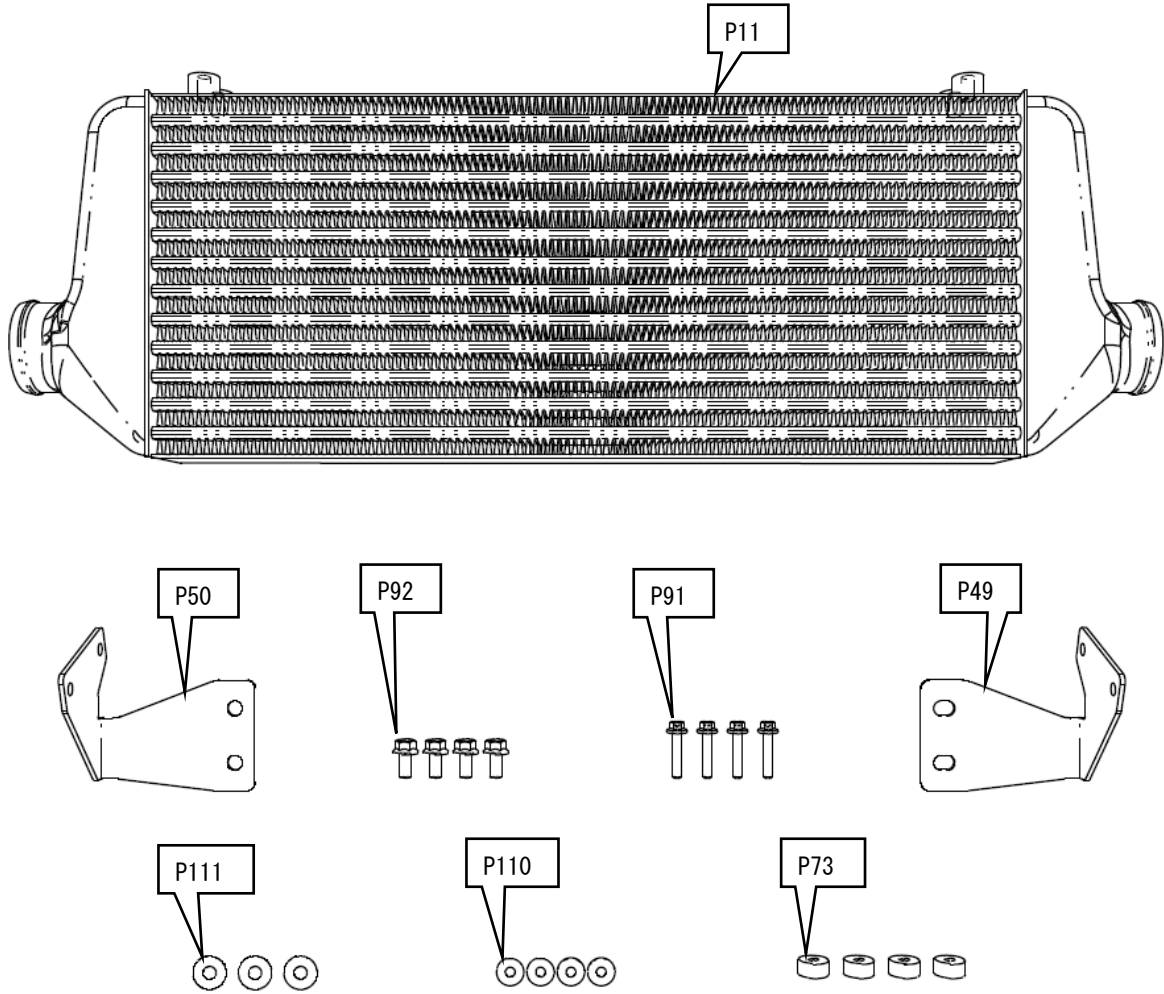

NO.	DESCRIPTION	QT
P11	Intercooler	1
P49	Intercooler Bracket No.1	1
P50	Intercooler Bracket NO.2	1
P73	Spacer M6 L=10	4
P91	Hex Flange Bolt M6 L=30	4
P92	Hex Flange Bolt M8 L=16	4
P110	Large Diameter Washer M6	4
P111	Large Diameter Washer M8	3

(1) Temporarily install the Intercooler Bracket No.1 and No.2 to the Intercooler using ① Hex Flange Bolt M8 L=16, and ② Large Diameter Washer M8.

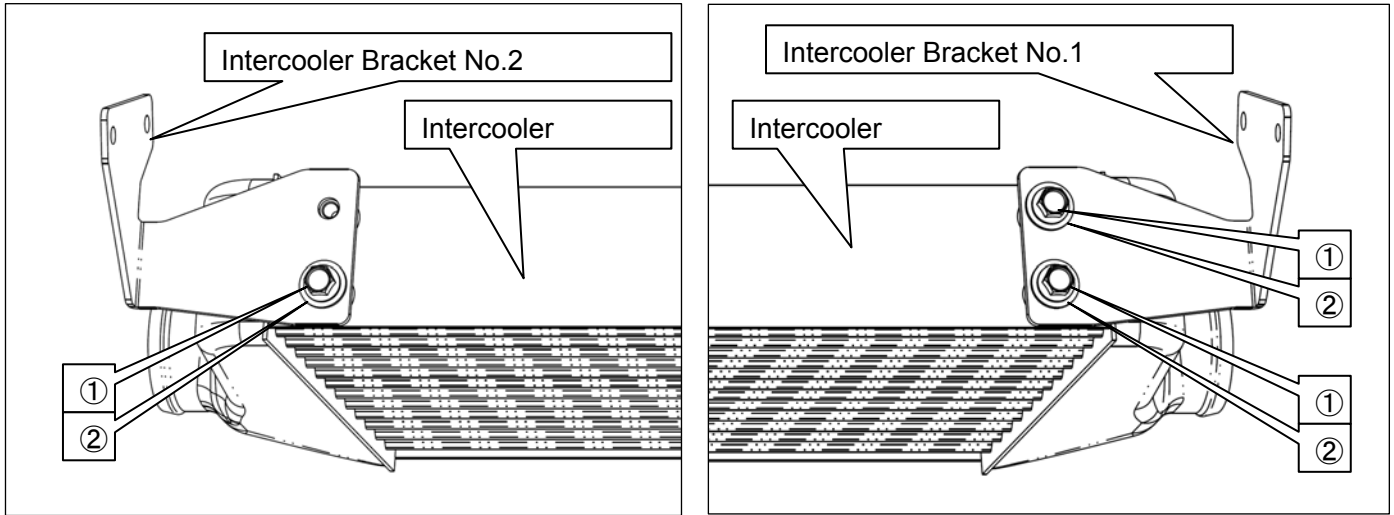

(2) Install the Intercooler assembly to the vehicle using ① Hex Flange Bolt M6 L=30, ② Large Diameter Washer M6, and ③ Spacer M6 L=10.

**NOTE**

- If the Intercooler assembly comes in contact with the A/C pipe, bend the A/C pipe to make clearance.

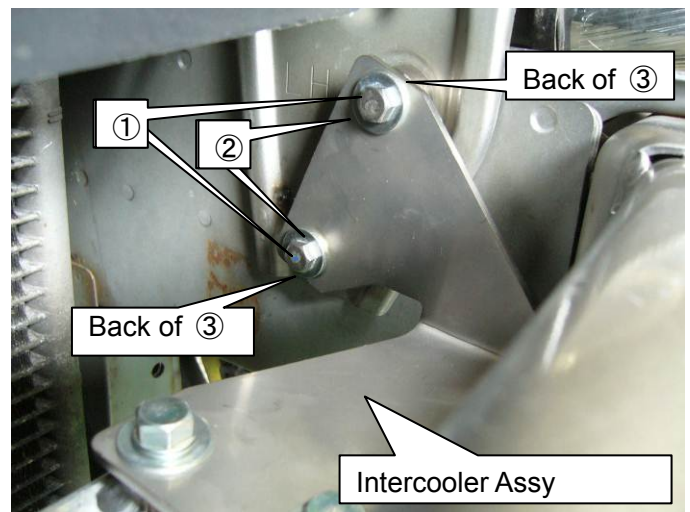

(3) Tighten the bolts temporarily installed in (1).

(4) Install the Traction Fluid Cooler assembly to the Intercooler assembly using ④ Hex Flange Bolt M8 L=16.

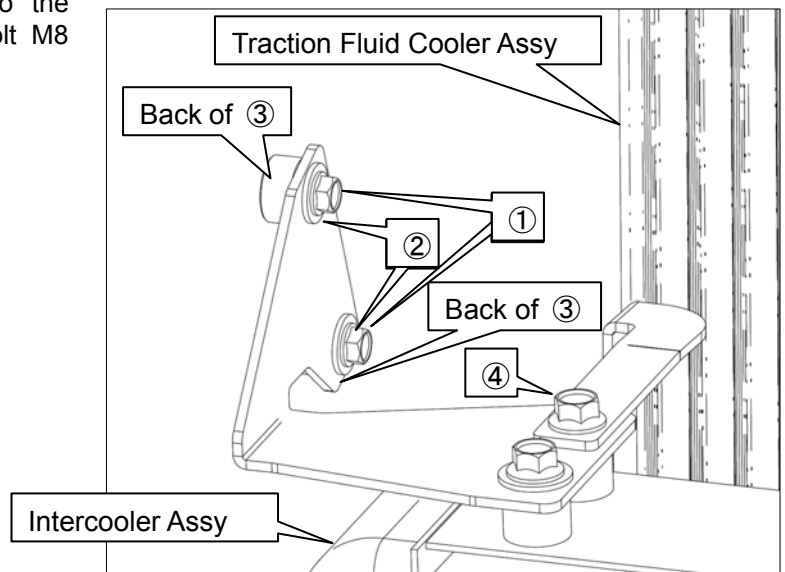



(5)Cut off the shaded portion on both sides of the front under cover so it does not come in contact with the Intercooler.

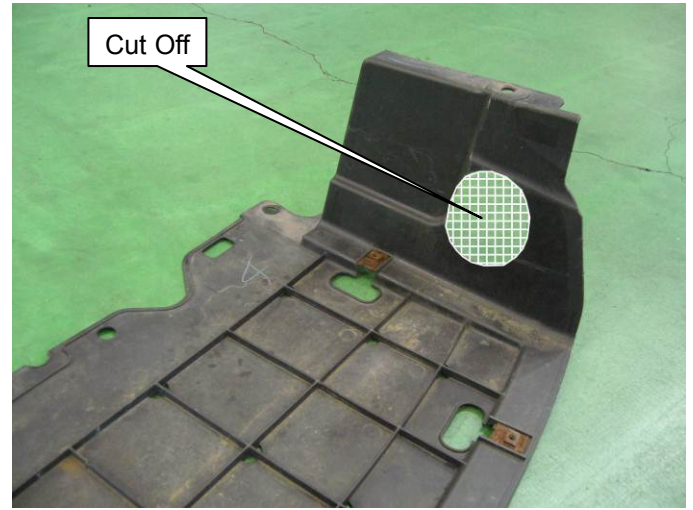

(6)Reinstall the front under cover to the vehicle.

(7)Remove ① Hexagon Bolt M6 L=25, ② Large Diameter Washer M6, and ③Spacer M6 L=4 from the Traction Fluid Cooler assembly. Reinstall the front air guide using these removed parts.

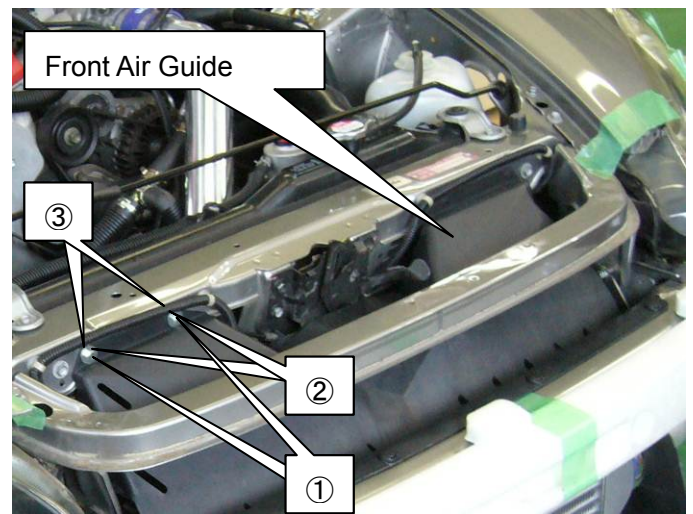

• Installation of Intercooler Inlet Pipes

PARTS LIST

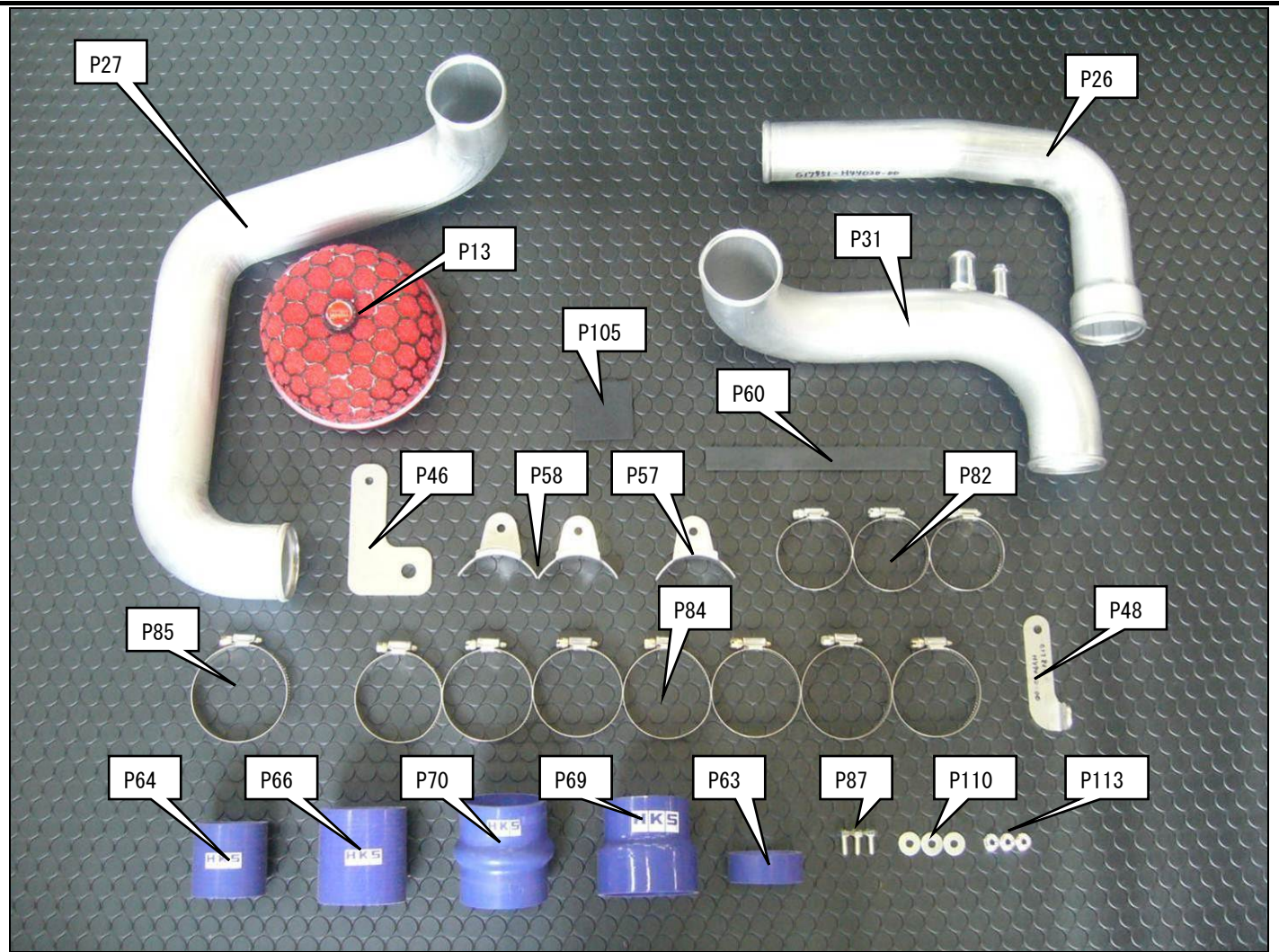

No	品名	数量
P13	Air Cleaner	1
P26	Intercooler Inlet Pipe No.1	1
P27	Intercooler Inlet Pipe No.2	1
P31	Suction Pipe No.1	1
P46	Intercooler Inlet Pipe Bracket	1
P48	Suction Pipe Bracket	1
P57	Universal Pipe Bracket 50mm	1
P58	Universal Pipe Bracket 60mm	2
P60	Insulator Rubber	1
P63	Silicone Hose 50mm L=20	1
P64	Silicone Hose 50mm L=55	1
P66	Silicone Hose 60mm L=70	1
P69	Silicone Hose 60mm-70mm	1
P70	Cushion Hose 60mm L=75	1
P83	Hose Clamp #28	3

P84	Hose Clamp #36	7
P85	Hose Clamp #40	1
P87	Hexagon Bolt M6 L=15	3
P110	Large Diameter Washer M6	3
P113	Flange Nut M6	3
P105	Sponge Sheet	1

- (8) Install the Intercooler Inlet Pipe Bracket together with  
 ① Factory stabilizer bracket fixture bolt.

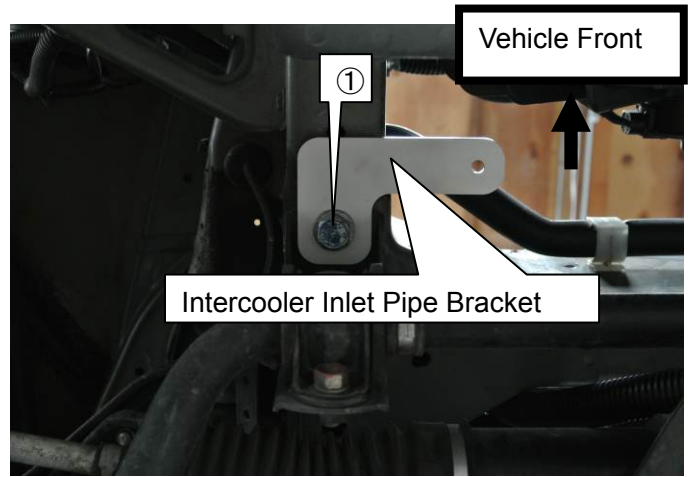

- (9) Cut off the shaded portion of the Radiator Fan Shroud.

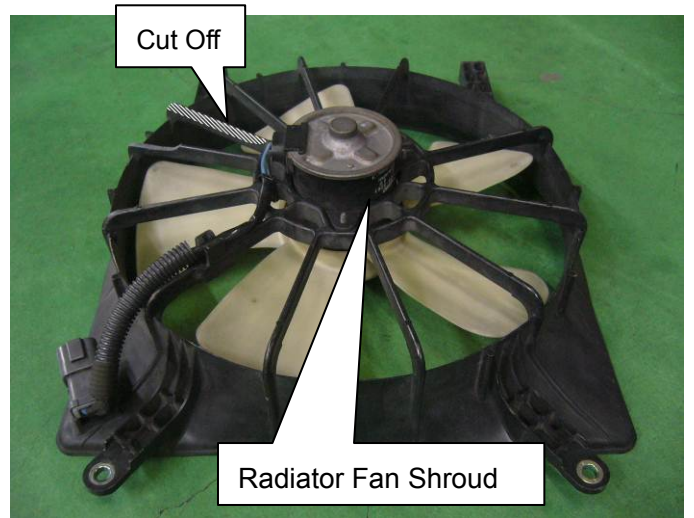

- (10) Temporarily install the following parts to the Intercooler Inlet Pipe No.1:

- ① Silicone Hose 50mm L=55
- ② Silicone Hose 50mm L=20
- ③ Hose Clamp #28
- ④ Universal Pipe Bracket 50mm

**NOTE**

- Install the Universal Pipe Bracket 50mm as shown in the diagram on the right for easier installation.

Intercooler Inlet Pipe No.1

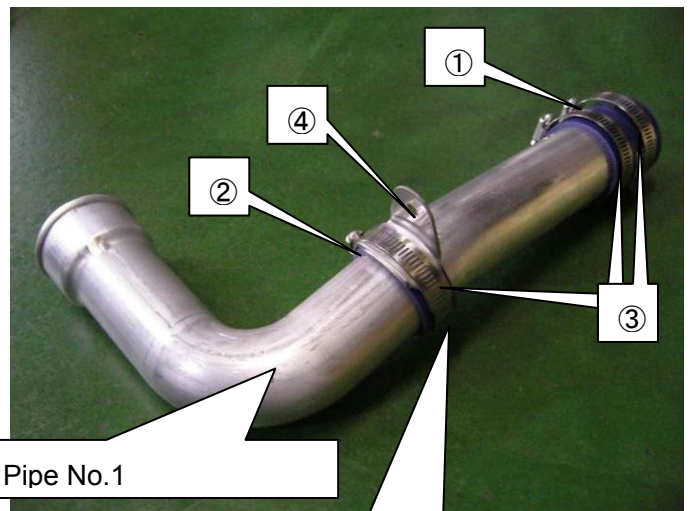

(11) Temporarily install the Intercooler Inlet Pipe No.1 assembly to the Supercharger Unit assembly.

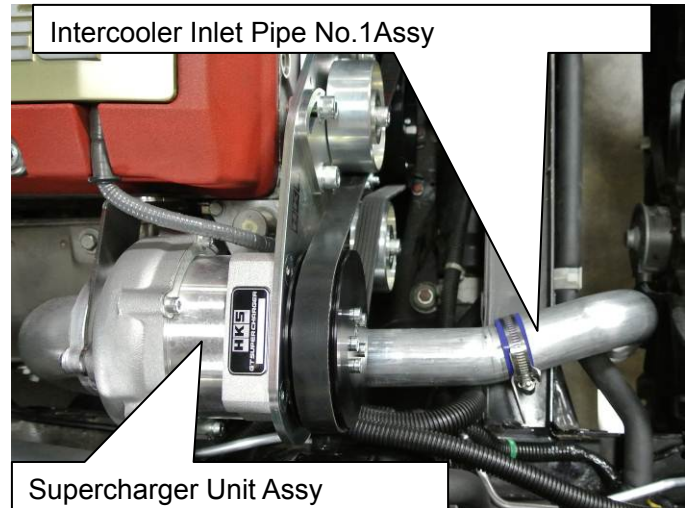

(12) Temporarily install the following parts to the Intercooler Inlet Pipe No.2:

- ① Cushion Hose 60mm L=75
- ② Hose Clamp #36
- ③ Insulator Rubber
- ④ Universal Pipe Bracket 60mm
- ⑤ Silicone Hose 60mm L=70

**NOTE**

• Install the Universal Pipe Bracket 60mm as shown in the diagram on the right for easier installation.

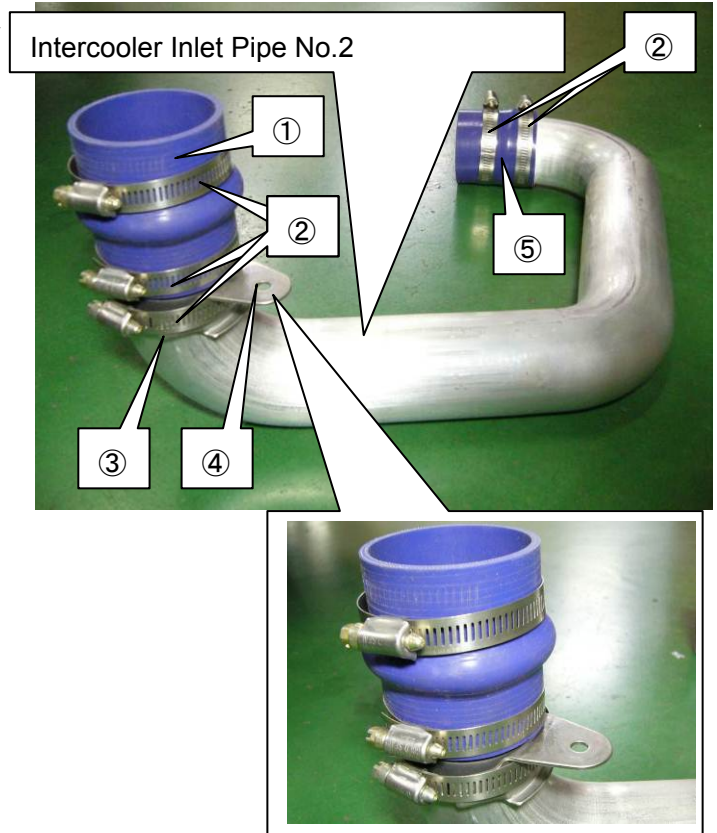

(13) Temporarily install the Intercooler Inlet Pipe No.2 assembly to the vehicle.

(14) Temporarily install the Intercooler Inlet Pipe No.2 assembly to the Intercooler Inlet Pipe Bracket using the following parts:

- ① Hexagon Bolt M6 L=15
- ② Large Diameter Washer M6
- ③ Flange Nut M6

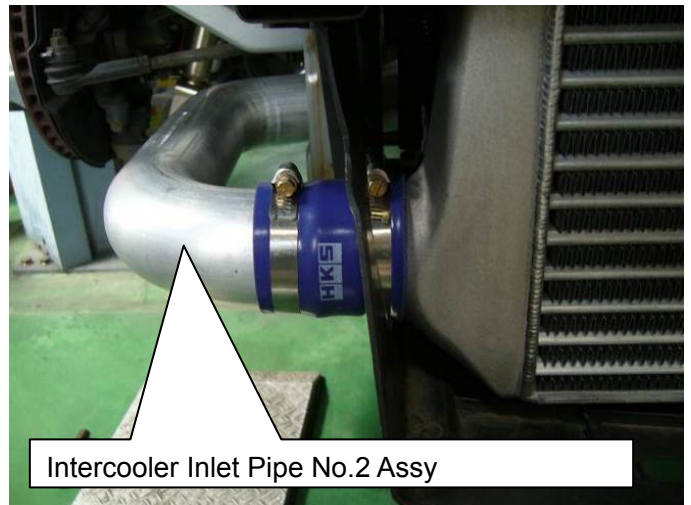
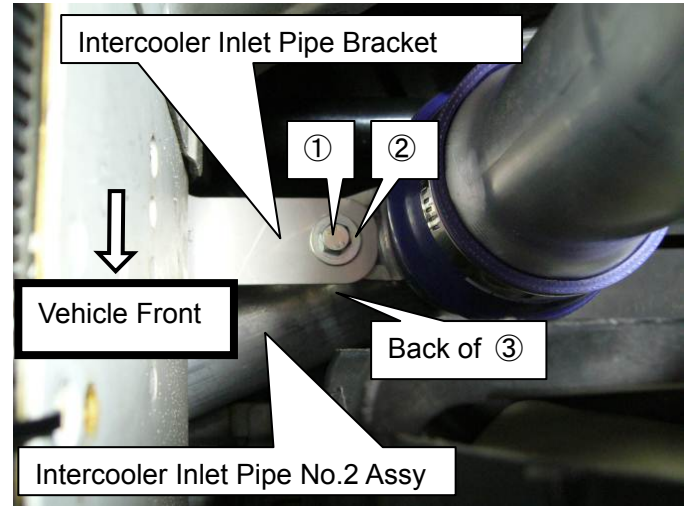

(15) Adjust the position of the Intercooler Inlet Pipe No.1 and No.2. Tighten the bolts and hose clamps securely.

**NOTE**

- Make sure the inlet pipes do not come in contact with any other parts of the vehicle.

(16) Cut off the shaded portion of the right side inner fender so it does not come in contact with pipes.

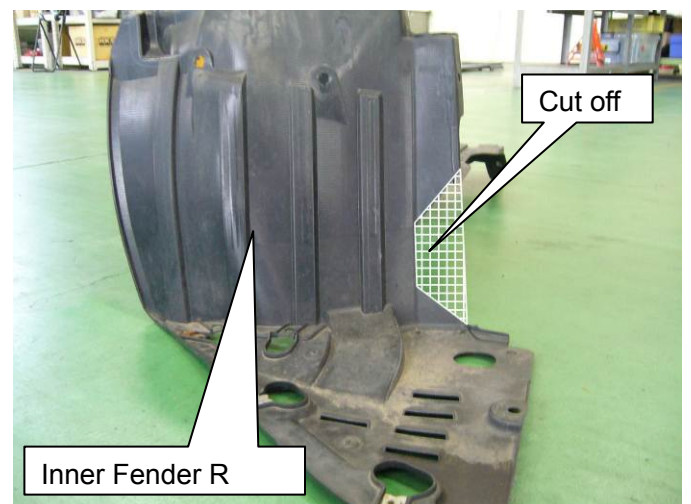

(17) Temporarily install ⑤Air Cleaner to the Suction Pipe No.1 using the following parts:

- ①Silicone Hose 60mm-70mm
- ②Hose Clamp #36
- ③Hose Clamp #40
- ④Universal Pipe Bracket 60mm

**NOTE**

• Install the Universal Pipe Bracket 60mm as shown in the diagram on the right for easier installation.

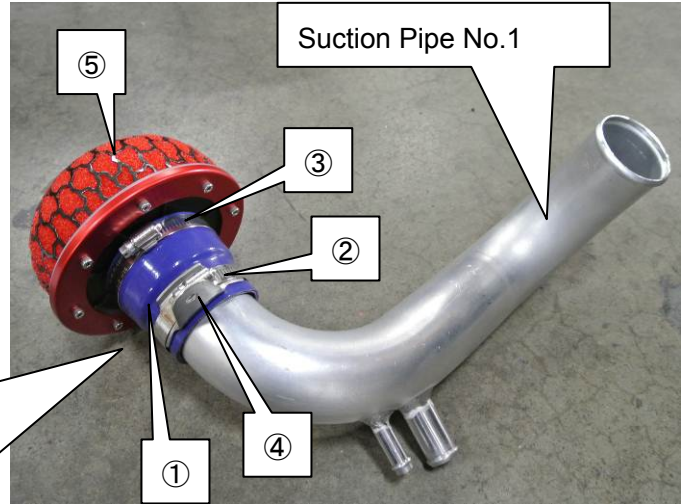

(18) Install the Suction Pipe No.1 to the Suction Pipe No.2 using ①Hose Clamp #36.

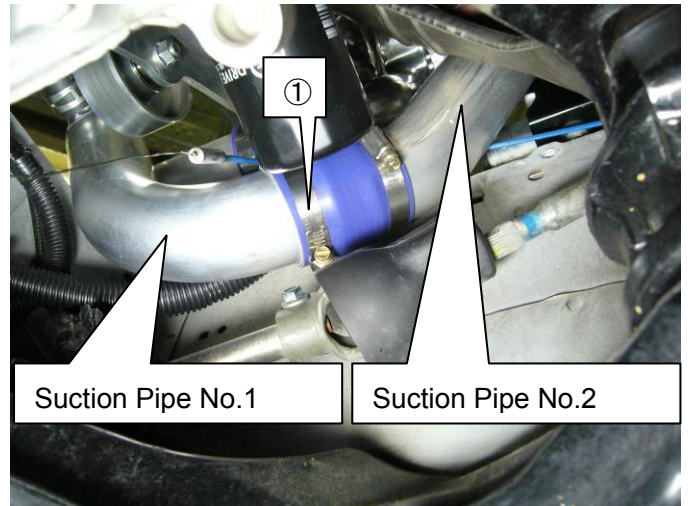

(19) Affix the provided Sponge Sheet to the portion where the Suction Pipe No.1 may come in contact with the Intercooler Inlet Pipe No.1.

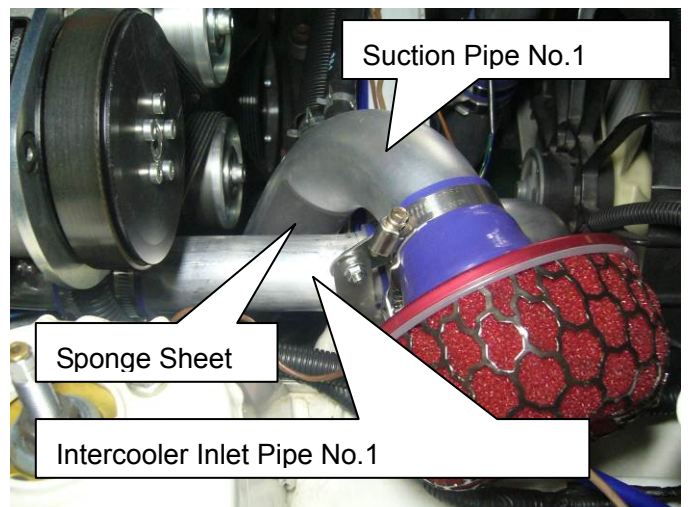

(20) Install the Suction Pipe No.1 assembly to the Intercooler Inlet Pipe No.1 assembly using the following parts:

- ① Suction Pipe Bracket
- ② Hexagon Bolt M6 L=15
- ③ Large Diameter Washer M6
- ④ Flange Nut M6

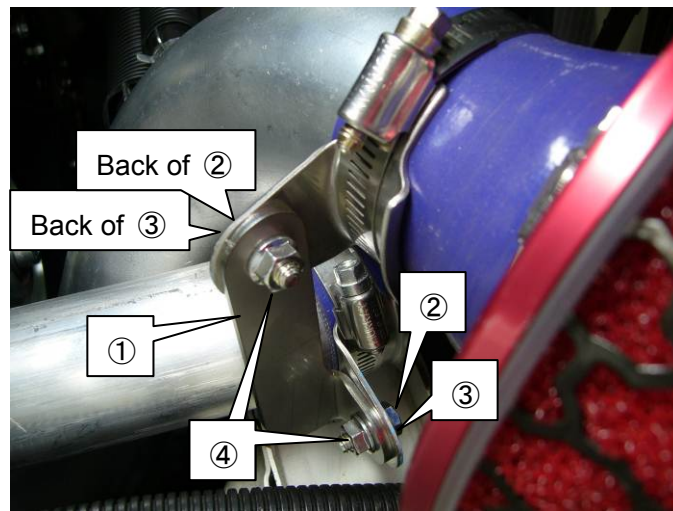
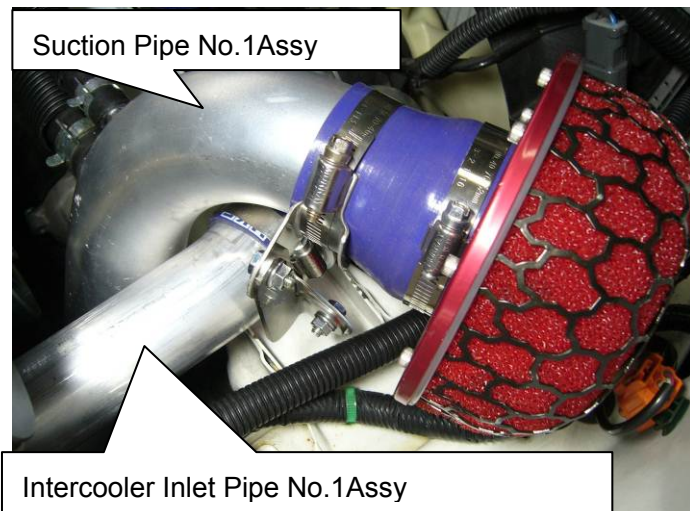



• Installation of Outlet Pipes

PARTS LIST

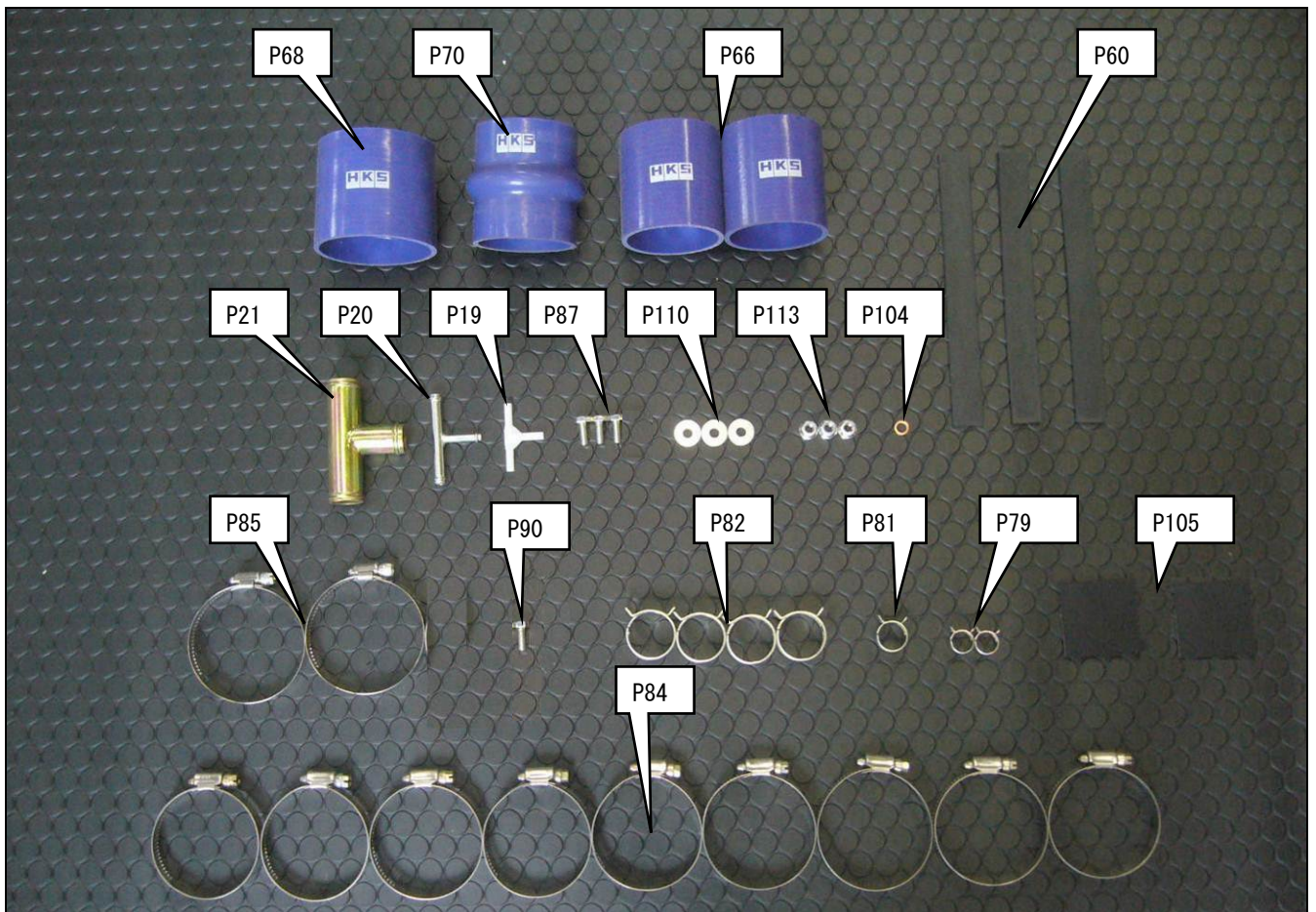
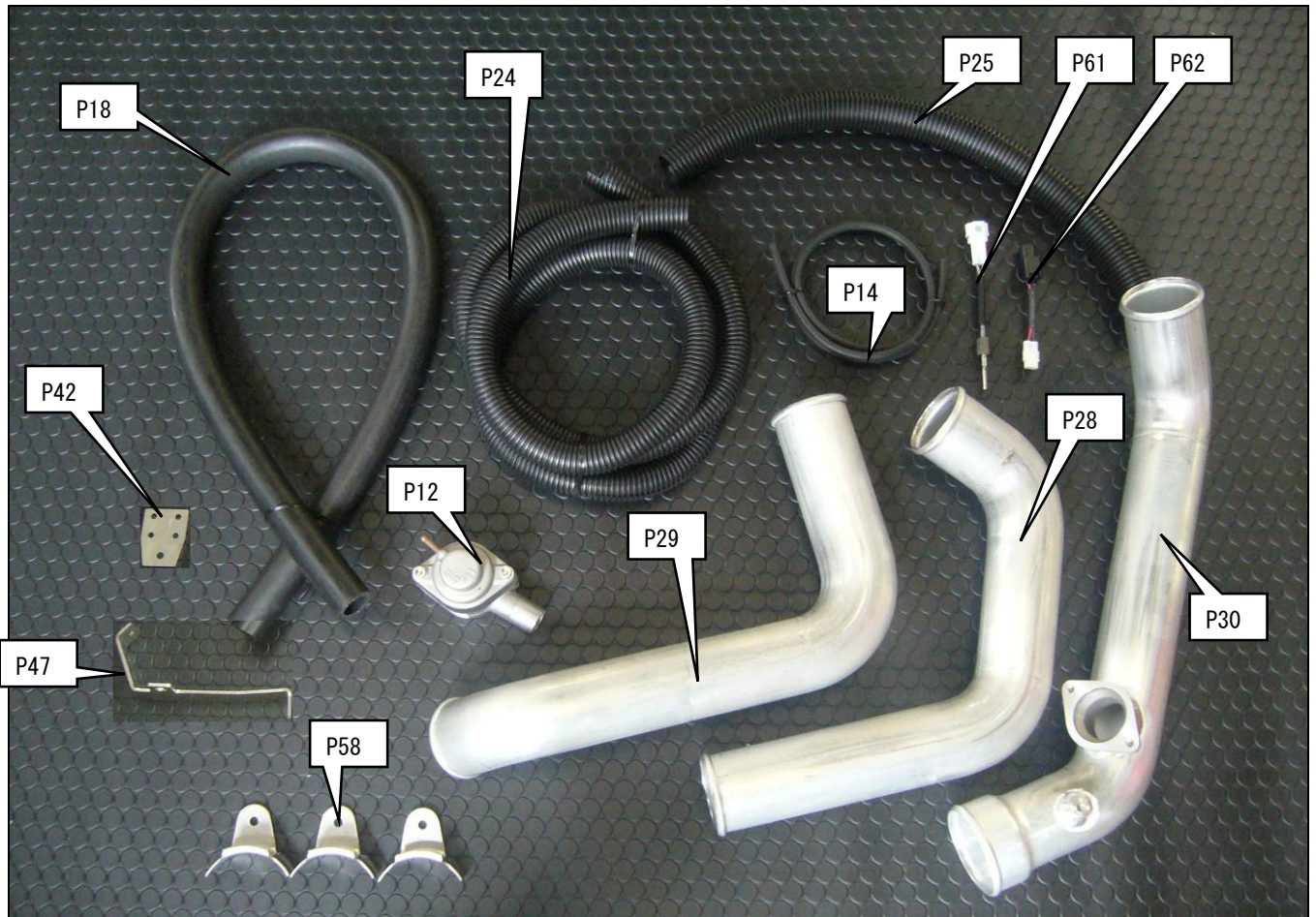

№	品名	数量
P12	Relief Valve Assembly	1
P14	Hose 4mm	1 (Reuse)
P15	Hose 8mm	1
P18	Hose 22mm	1
P19	T-fitting 4mm-4mm-4mm	1
P20	T-fitting 8mm-4mm-8mm	1
P21	T-fitting 22mm-19mm-22mm	1
P24	Corrugated Tube 12mm	1 (Reuse)
P25	Corrugated Tube 22mm	1
P28	Intercooler Outlet Pipe No.1	1
P29	Intercooler Outlet Pipe No.2	1
P30	Intercooler Outlet Pipe No.3	1
P42	Traction Fluid Filter Bracket	1
P47	Intercooler Outlet Pipe Bracket	1
P58	Universal Pipe Bracket 60mm	3
P60	Insulator Rubber	3
P61	Intake Air Temperature Sensor	1
P62	Intake Air Temperature Sensor Harness	1
P66	Silicone Hose 60mm L=70	2
P68	Silicone Hose 70mm L=70	1
P70	Cushion Hose 60mm L=75	1
P79	Hose Clip 8mm	2
P81	Hose Clip 12mm	1
P82	Hose Clip 22mm	4
P84	Hose Clamp #36	9
P85	Hose Clamp #40	2
P87	Hexagon Bolt M6 L=15	3 (Reuse)
P90	Hexagon Bolt M8 L=15	1
P104	Copper Washer M8	1
P110	Large Diameter Washer M6	3
P113	Flange Nut M6	3
P105	Sponge Sheet	2

※(21)~(24)This procedure is required only for a vehicle with the wire throttle control system.

(21)Cut the Corrugated Tube 12mm to 350mm and 250mm in length

(22)Install ① 250mm Corrugated Tube 12mm and ② 350mm Corrugated Tube 12mm to the 2nd air pump inlet hose as shown in the diagrams below.

(23)Secure the 2nd air pump outlet hose to the inlet hose clamp as shown in the diagram below.

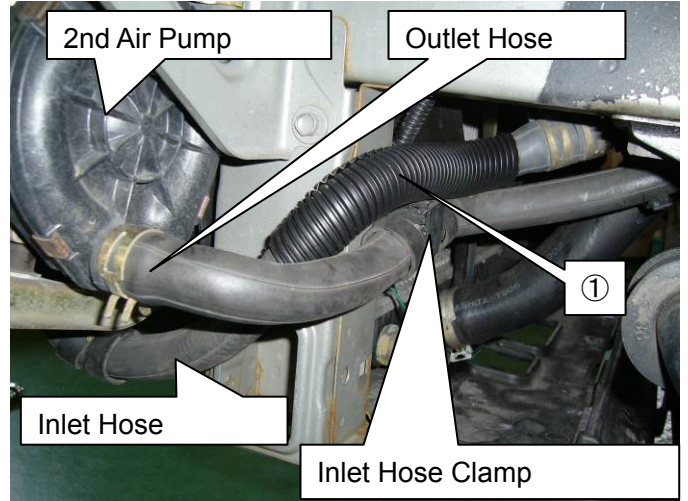

(24)Adjust the position of the 2nd air pump inlet hose as shown in the diagram below.

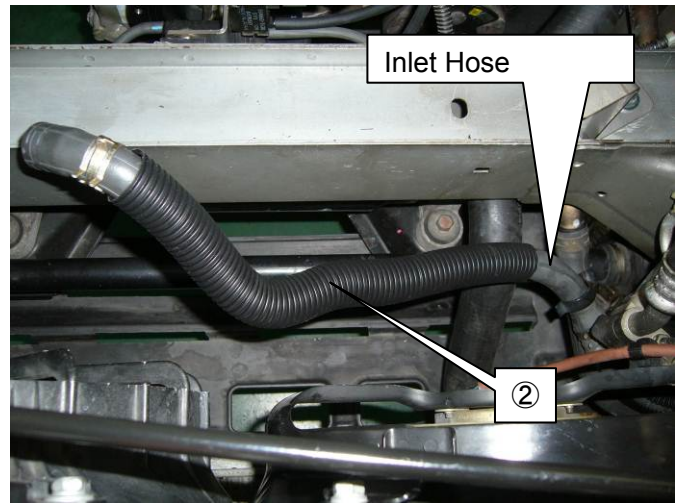

(25)Install the Intercooler Outlet Pipe Bracket using ① factory stabilizer bracket fixture bolt as shown in the diagram on the right.

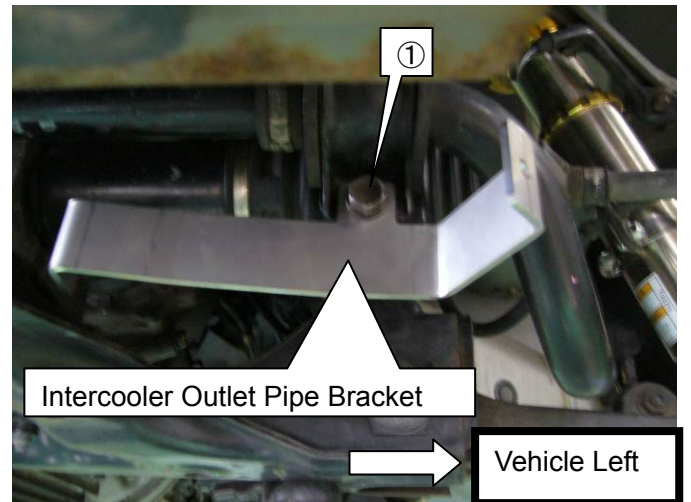

※(26)This procedure is required only for a vehicle with the wire throttle control system.

(26)Secure the secondary air pump harness using ①Tie Wrap so it does not come in contact with the pipe.

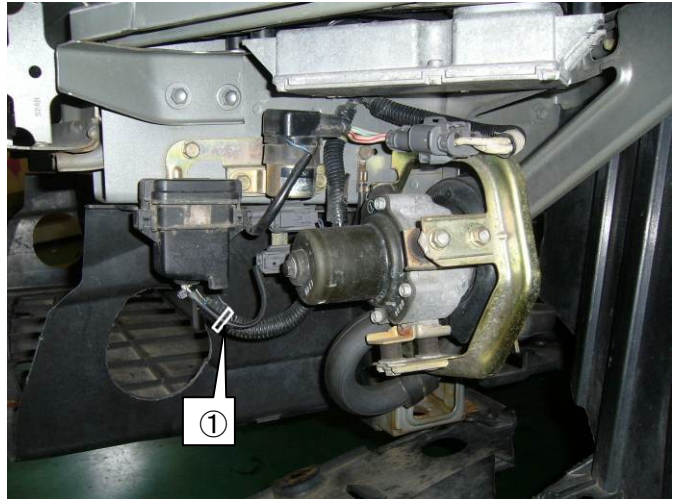

(27)Temporarily install the following parts to Intercooler Outlet Pipe No.1:

- ①Silicone Hose 60mm L=70
- ②Hose Clamp #36
- ③Insulator Rubber
- ④Universal Pipe Bracket 60mm

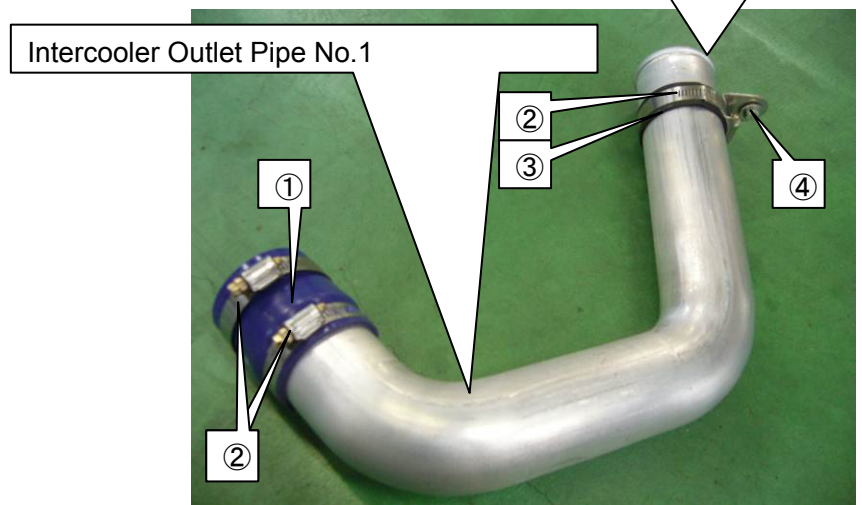

(28) Temporarily install the following parts to Intercooler Outlet Pipe No.2:

- ① Silicone Hose 60mm L=70
- ② Hose Clamp #36
- ③ Insulator Rubber
- ④ Universal Pipe Bracket 60mm
- ⑤ Cushion Hose 60mm L=75

(29) Temporarily install the following parts to Intercooler Outlet Pipe No.2:

- ⑥ Hexagon Bolt M6 L=15
- ⑦ Large Diameter Washer M6
- ⑧ Flange Nut M6
- ⑨ Traction Fluid Filter Bracket

Route ⑩ Tie Wrap (L) as shown in the diagram on the right.

**NOTE**

- Install the Universal Pipe Bracket 60mm as shown in the diagram on the right for easier installation.

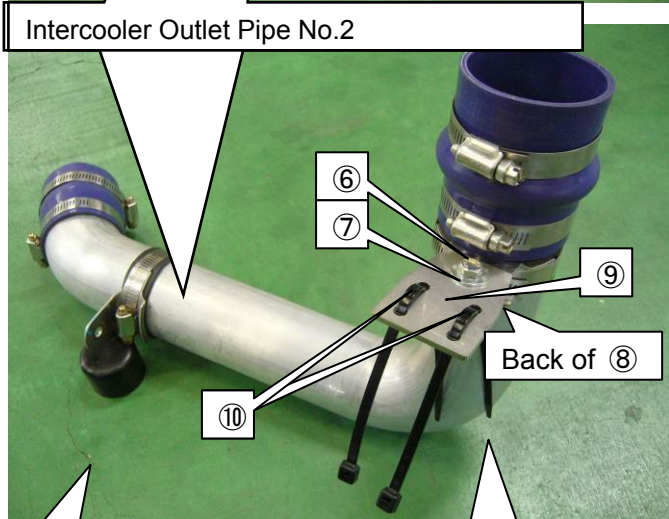
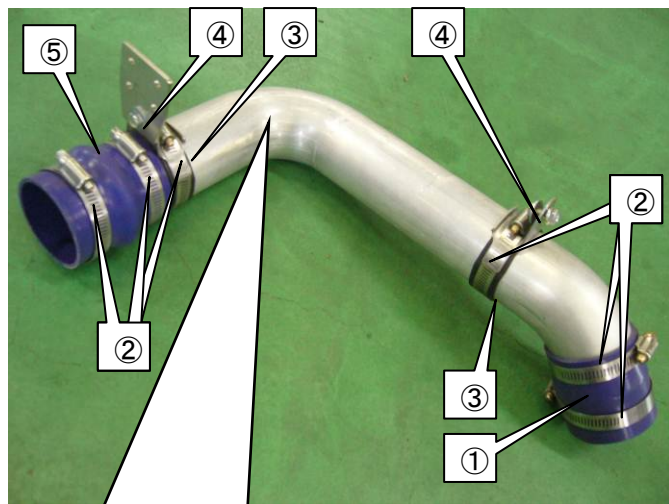

(30) Temporarily install the Intercooler Outlet Pipe No.1 and No.2 to the vehicle using ①Hexagon Bolt M6 L=15, ②Large Diameter Washer M6, and ③Flange Nut M6.

(31) Affix the Sponge Sheet to the portion of the Intercooler Outlet Pipe No.2 where it may come in contact with the suspension member.

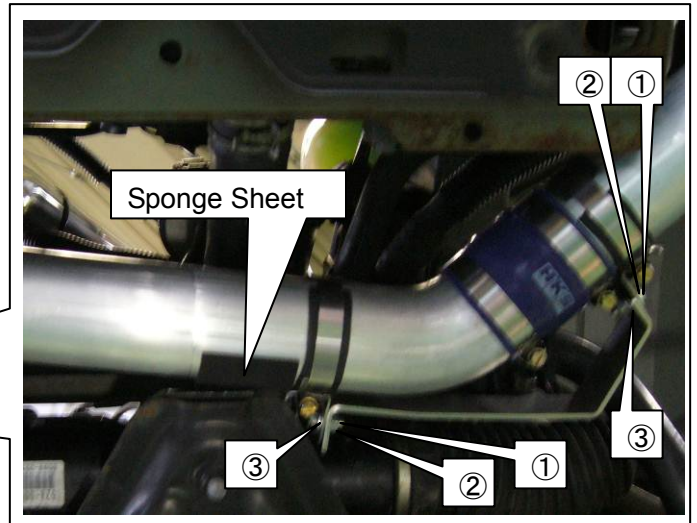
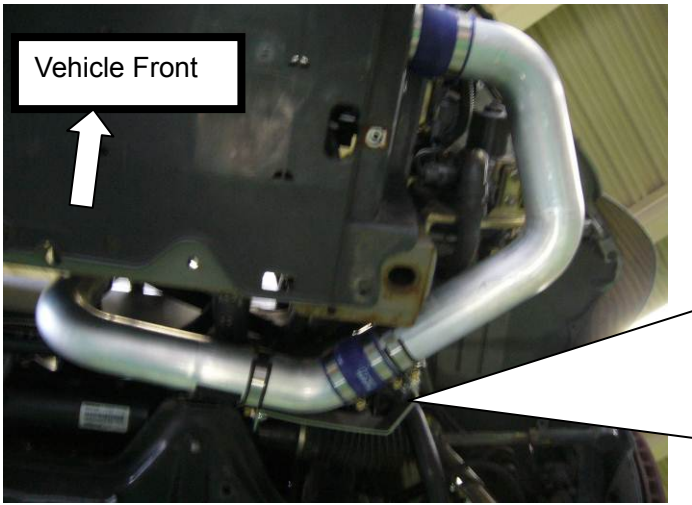

(32) Install the Relief Valve Assembly to the Intercooler Outlet Pipe No.3 after inserting the gasket of the Relief Valve Assembly between the pipe and valve.

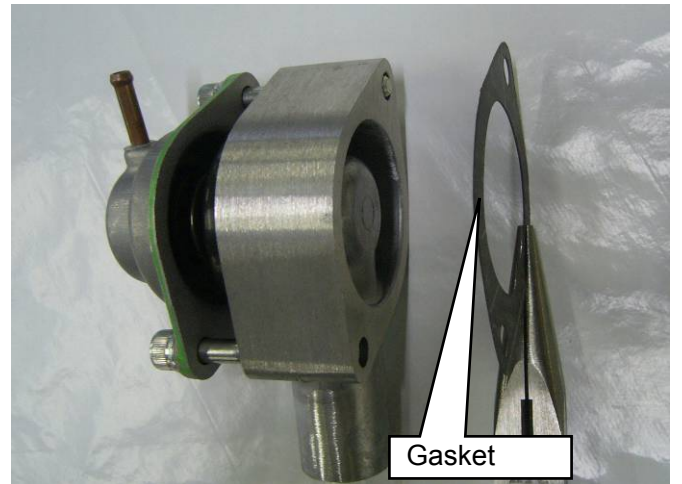

(33) Temporarily install the following parts to Intercooler Outlet Pipe No.3:

- ① Silicone Hose 70mm L=70
- ② Hose Clamp #40

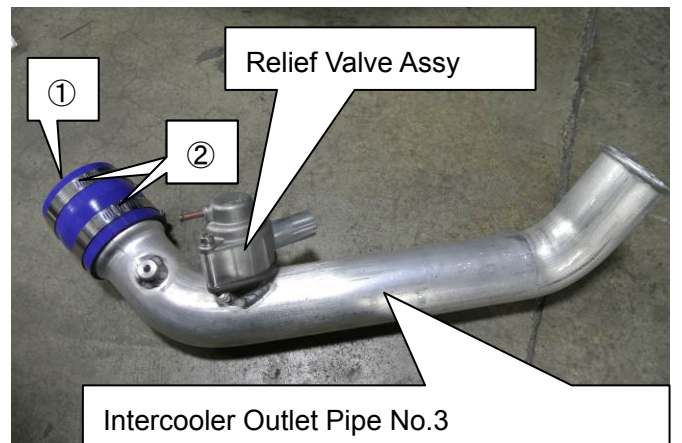

※(34)~(36)This procedure is required only for a vehicle with the wire throttle control system.

(34)Install ①Hexagon Bolt M8 L=15 and ②Copper Washer to the Intercooler Outlet Pipe No.3 assembly.

(35)Cut the Hose 22mm to 260mm and 100mm in length.

(36)Install ③Hose 22mm L=100mm, ④Hose Clip 22mm, and ⑤ T-fitting 22mm-19mm-22mm to the Relief Valve assembly.

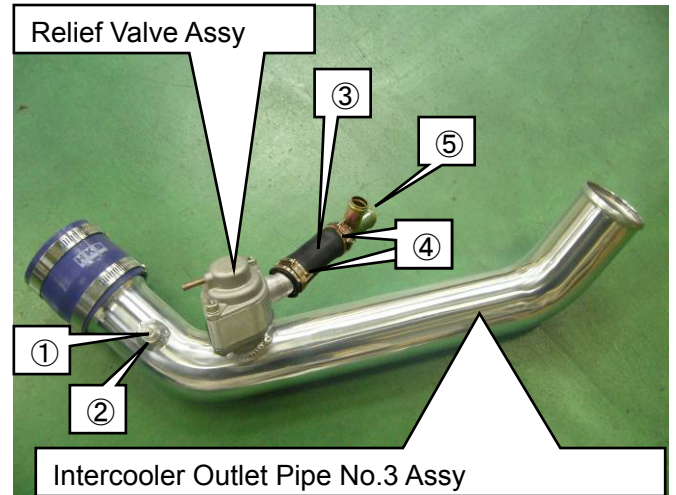

※(37)~(39)This procedure is required only for a vehicle with the electronic throttle control system.

(37)Install ①Intake Air Temperature Sensor and ② Copper Washer to the Intercooler Outlet Pipe No.3 assembly.

**NOTE**

- Make sure to tighten the sensor to the tightening torque specified below to avoid damage to the valve.

**Tightening Torque N·m(kgf·m)**

T=10(1.0)

(38)Cut the Hose 22mm to 380mm in length.

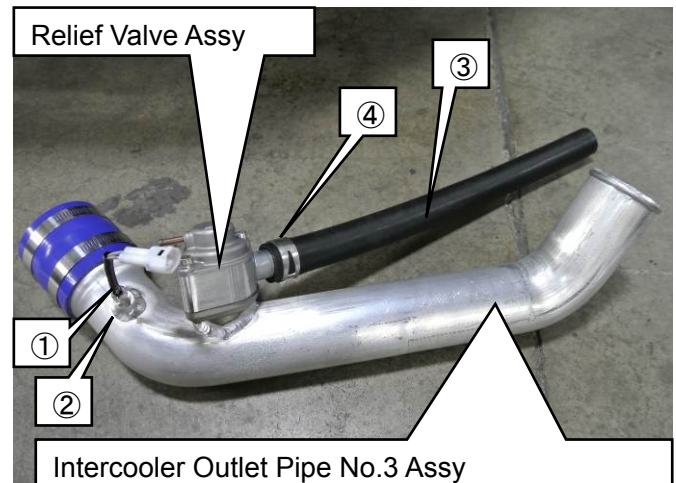

(39)Install ③Hose 22mm L=380mm and ④Hose Clip 22mm to the Relief Valve assembly.

※(40)~(44)This procedure is required only for a vehicle with the wire throttle control system.

(40)Temporarily install the Intercooler Outlet Pipe No.3 assembly to the vehicle.

(41)Connect ④Hose 22mm L=260 and ⑤factory secondary air pump inlet hose using ①T-fitting 22mm-19mm-22mm, ②Hose Clip 22mm, and ③factory hose clip 19mm.

(42) Cut the Corrugated Tube 22mm to 210mm.

(43) Cover ④Hose 22mm L=260 with ⑥Corrugated Tube 22mm.

(44) Secure ⑤factory secondary air pump inlet hose to the Intercooler Outlet Pipe No.3 assembly using ⑦Tie Wrap (L), ⑧Tie Wrap (M), and ⑨Tie Wrap (S) as shown in the diagram on the right.

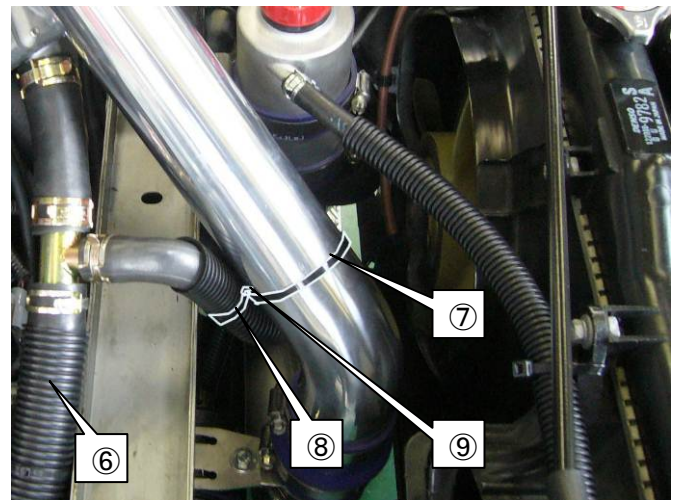
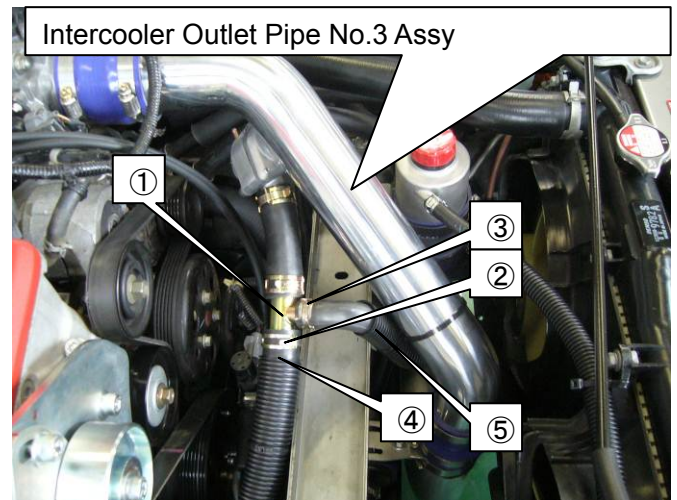

※(45)~(47)This procedure is required only for a vehicle with the electronic throttle control system.

(45)Temporarily install the Intercooler Outlet Pipe No.3 assembly to the vehicle.

(46)Cut the Corrugated Tube 22mm to 380mm in length.

(47) Install ②Corrugated Tube 22mm to ①Hose 22mm L=380.

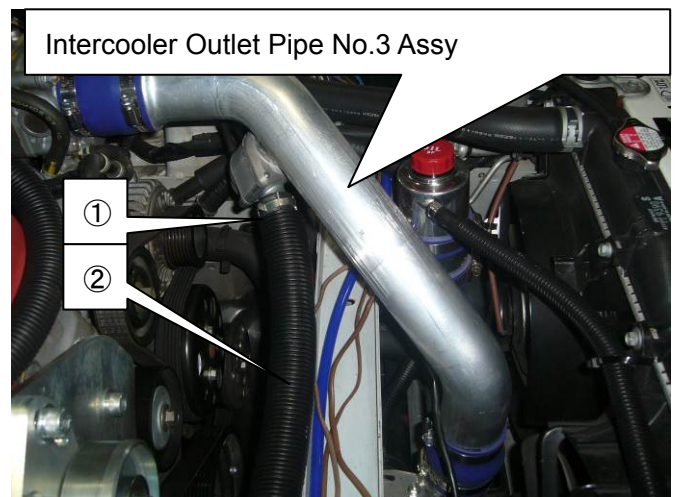

(48) Adjust the position of the Intercooler Outlet Pipe No.1, No.2 and No.3. Tighten the bolts and hose clamp securely.

**NOTE**

- Make sure the outlet pipes do not come in contact with any other parts of the vehicle.  
(Important Parts to Check: Intercooler Outlet Pipe No.2 x factory coolant hose, Suspension member, Stabilizer)



(49)Slide the Traction Fluid Filter Bracket as shown in the diagram on the right. Affix ①Sponge Sheet to the portion where the Intercooler Outlet Pipe No.3 may come in contact with the Traction Fluid Filter.

(50)Secure the Traction Fluid Filter to the Traction Fluid Filter Bracket using ①Tie Wrap (L).

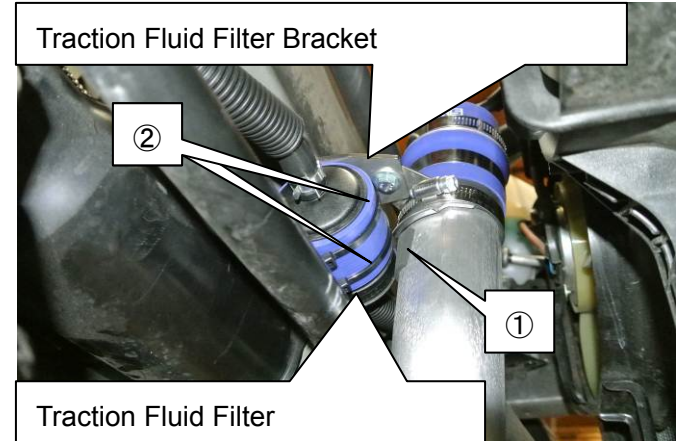
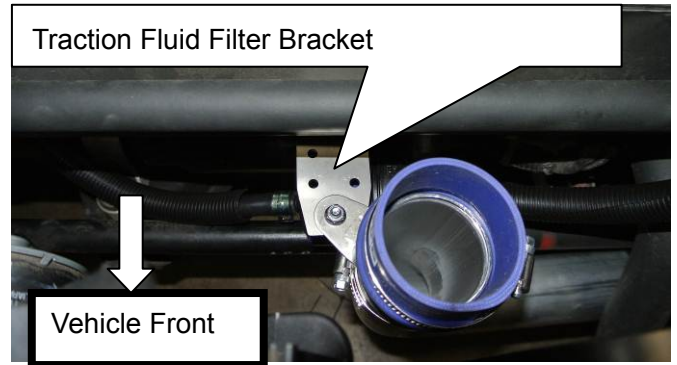

(51)Secure the Hose 22mm assembly to the Suction Pipe No.1 using ①Hose Clip 22mm.

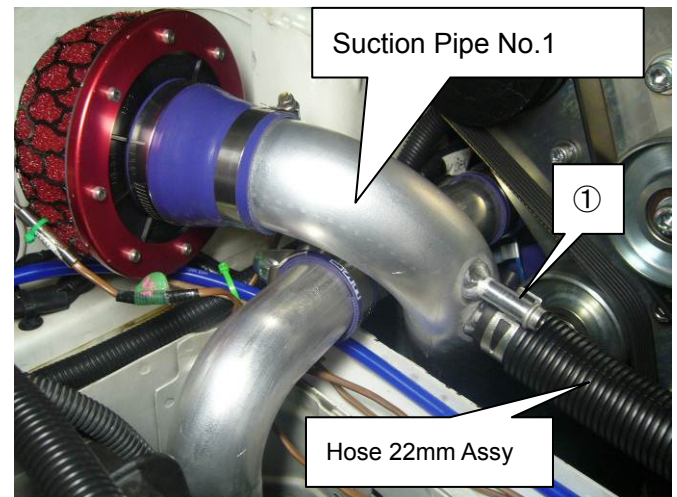

(52)Install the Hose 12mm assembly to the Suction Pipe No.1 using ①Hose Clip 12mm.

(53)Secure the Hose 12mm assembly to the Joint Pipe 8mm using ②Tie Wrap (M).

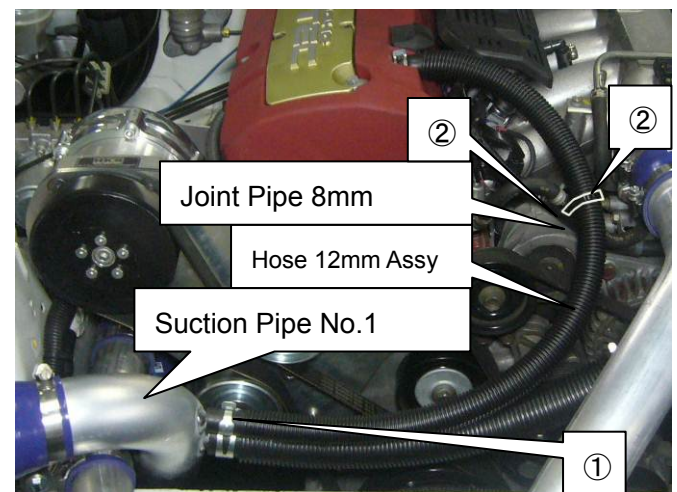

(54)Secure the Hose 12mm assembly to the Hose 22mm assembly using ①Tie Wrap(L), ②Tie Wrap(M), and ③Tie Wrap(S).

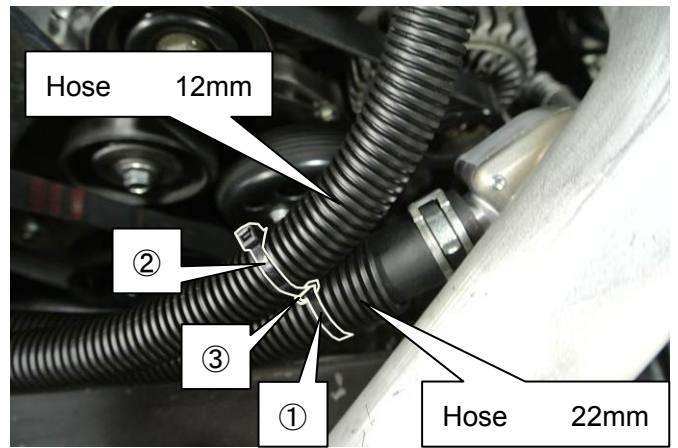

※(55)~(58)This procedure is required only for a vehicle with the wire throttle control system.

(55)Cut the factory fuel regulator operation pipe. Connect ①T-fitting 4mm-4mm-4mm to the pipe as shown in the diagram on the right.

(56)Connect ②Hose 4mm L=1000 to ①T-fitting 4mm-4mm-4mm.

(57)Connect ②Hose 4mm L=1000 to ③Relief Valve assembly. Secure the hose using ④Tie Wrap (M) and ⑤Tie Wrap (S).

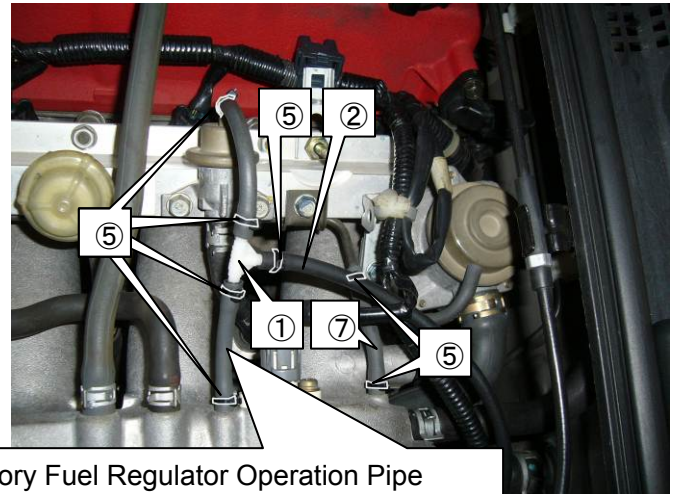

Factory Fuel Regulator Operation Pipe

(58)Secure ⑥Hose 4mm L=500 and hoses from ⑦factory secondary air control solenoid valve using ④Tie Wrap (M) and ⑤Tie Wrap (S).

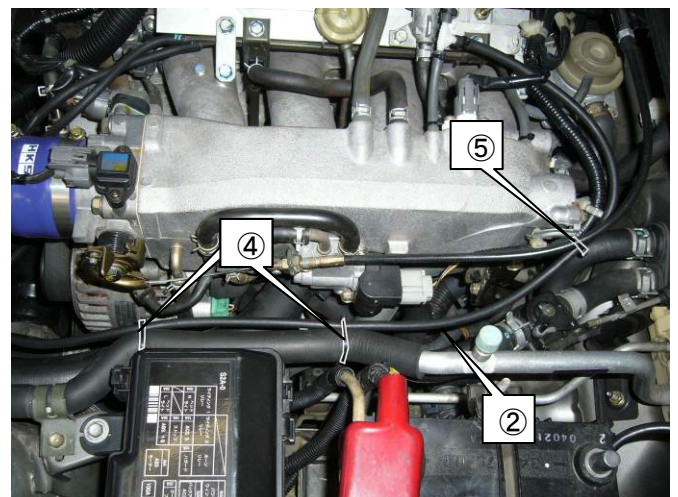
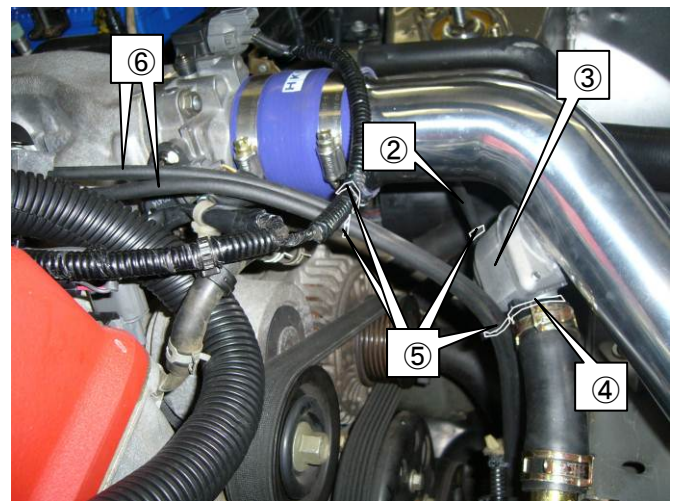

※(59)~(66)This procedure is required only for a vehicle with the electronic throttle control system.

(59)Cut the Hose 8mm to 50mm.

(60)Remove ①factory canister hose from the factory intake manifold. Cut off the hose at the point 50mm from the end.

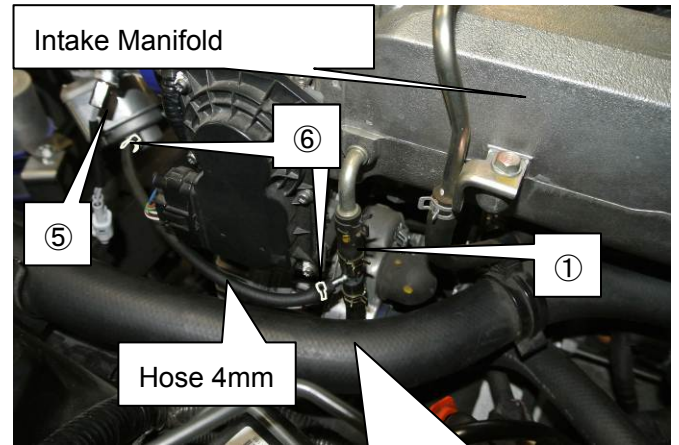

(61)Connect ②T-fitting 8mm-4mm-8mm to the Hose 8mm Cut in (59) and ①factory canister hose using ③Hose Clip 8mm and ④factory hose clip; then connect them to the intake manifold using ③Hose Clip 8mm.

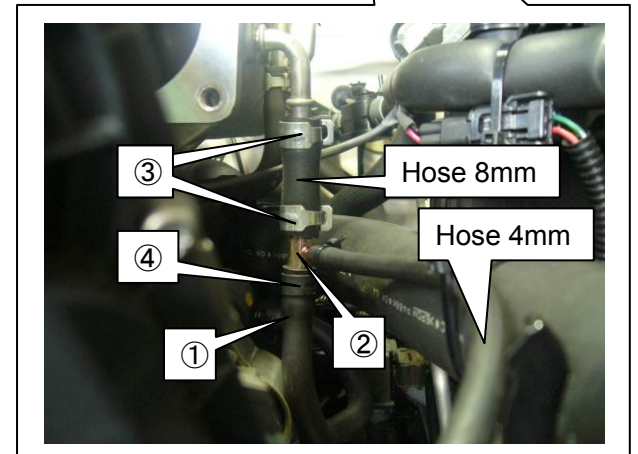

(62) Cut the Hose 4mm to 250mm in length.

(63)Connect ②T-fitting 8mm-4mm-8mm to ⑤Relief Valve assembly using the Hose 4mm cut in (62).

(64)Secure the Hose 4mm using ⑥Tie Wrap(S).

(65)Connect the Intake Air Temperature Sensor to ②factory intake air temperature sensor harness using ①Intake Air Temperature Sensor Harness.

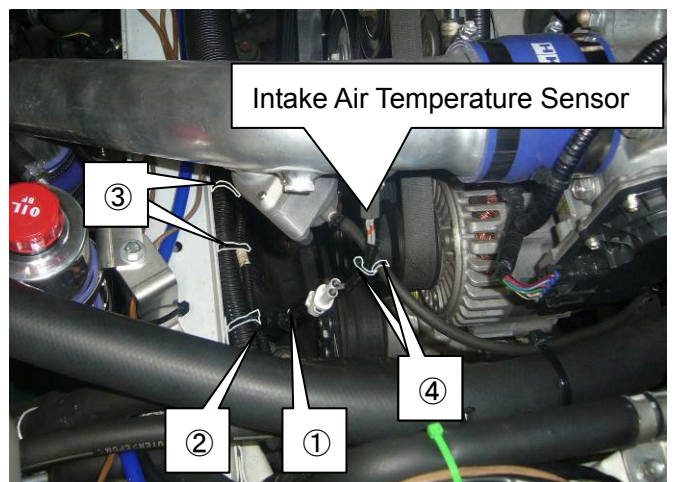

(66)Secure the Intake Air Temperature Sensor Harness using ③Tie Wrap (M) and ④Tie Wrap(S).

(67)Cut off the shaded portion of the right side inner fender so it does not come in contact with pipes.

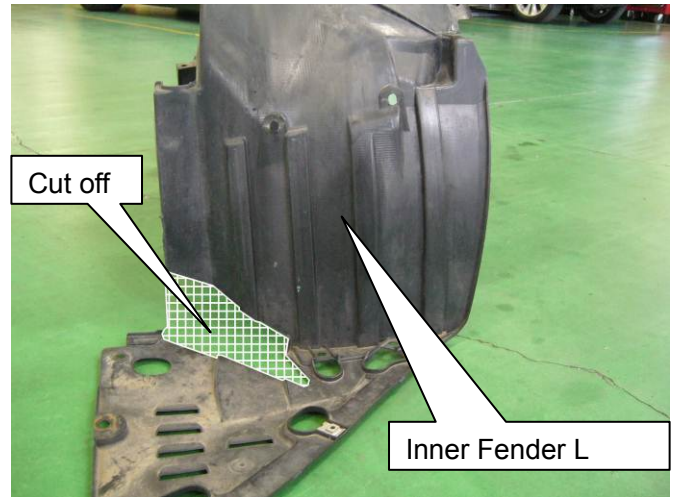

(68)Cut off the shaded portion of both sides' splash guard so they do not come in contact with pipes.

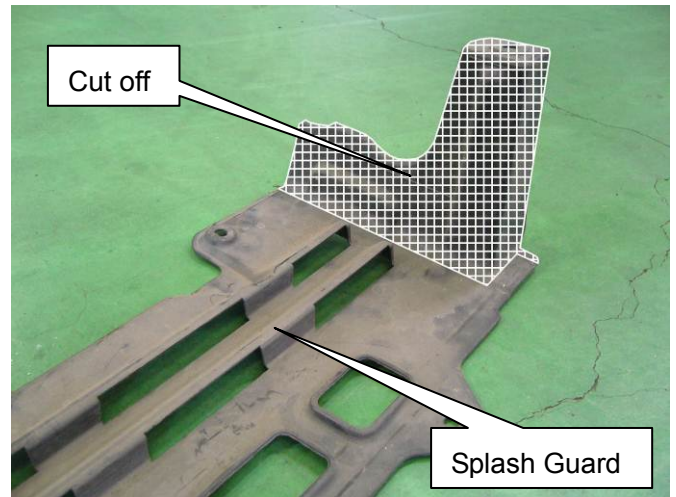

(69)Cut off the shaded portion of the front bumper so it does not come in contact with the intercooler.

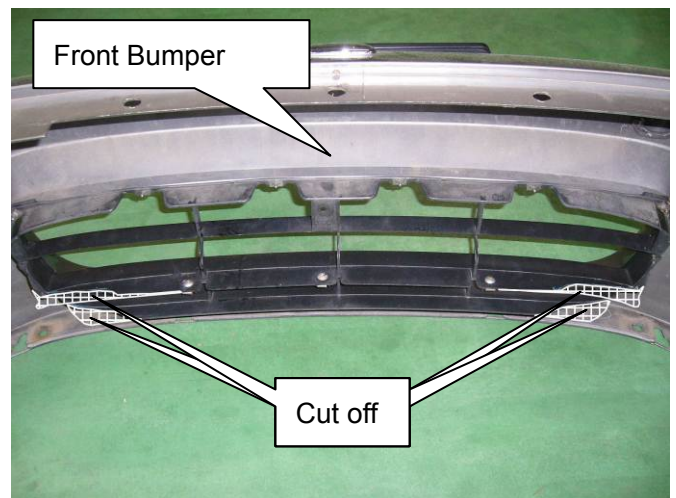

## 5. REINSTALLATION OF FACTORY PARTS

Refer to the factory service manual to reinstall the factory parts.

- (1)Reinstall the modified splash guard.
- (2)Reinstall the modified right side inner fender.
- (3)Reinstall the modified left side inner fender.
- (4)Reinstall the modified front bumper.
- (5)Reconnect the negative cable to the battery.

## 6. FILLING TRACTION FLUID

### PARTS LIST



NO.	DESCRIPTION	QT
P4	Traction Fluid	1



### CAUTION

Do not allow foreign objects to mix with the Traction Fluid. The internal components of the Supercharger Unit assembly are very precise and exact; foreign objects mixed with Traction Fluid can lead to damage to the Supercharger Assy.

- (1)Check to make sure that there are no foreign objects in the Oil Tank. Add Traction Fluid to the Traction Fluid Tank (up to the dotted line in the diagram below). Close the cap properly and securely.

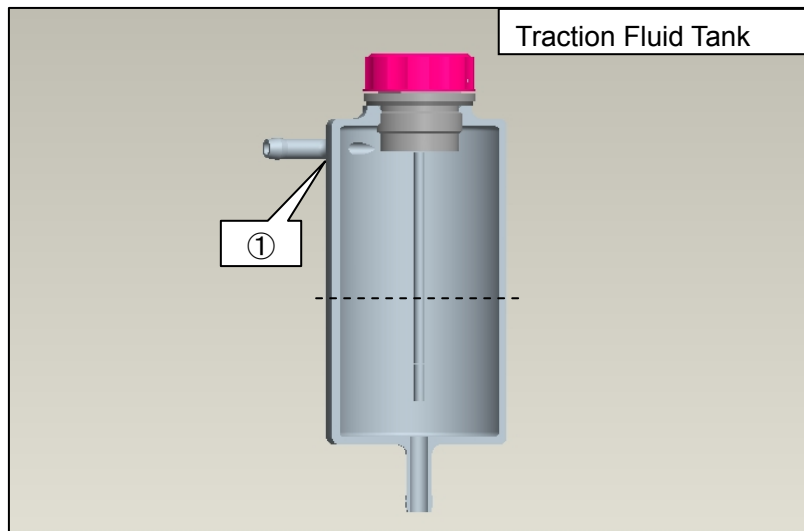

## 7. CONFIRMATION AFTER INSTALLATION / CHECKING TRACTION FLUID VOLUME

Check the following after the installation process is complete.

(1) Check off the following before starting the engine:

	Items to confirm:	Check
1	Make sure the hose layout is correct.	
2	Make sure the traction fluid is not leaking.	
3	Make sure the installed parts do not come in contact with any other parts.	
4	Make sure the belt is properly aligned with the grooves of the pulley.	
5	Make sure all bolts (especially the pulley bolts) are tightened properly.	
6	Make sure the Traction Fluid is at the correct level.	
7	Make sure hoses are not kinked or bent.	
8	Make sure all hose clamps are tight.	
9	Make sure all bolts and nuts are tightened.	
10	Make sure all installed components are secured.	
11	Make sure the setting data as the base is included.	

(2) Prepare 80cc (2.7 oz) of Traction Fluid in a beaker or small container and start the engine.

(3) Immediately after starting the engine, perform the following:

- i) Check to make sure that the oil level starts to decline, and then increase again.
- ii) Add oil from the 80cc beaker or small container, so that the Oil Tank level does not get empty. Also make sure that the Oil Tank does not overflow.

**NOTE**

- There may be some unusual or unpleasant noises emanating from the Supercharger unit after starting the engine. This is normal, and this noise will go away after the Traction Fluid warms up (approximately 2-3 minutes).

(4) Start the engine and perform the following checks after the engine reaches normal operating temperature:

**NOTE**

- Do not raise the engine RPM while the engine is warming up; let it idle.

	Items to confirm:	Check
1	Make sure the Traction Fluid returns to the Oil Tank.	
2	Make sure there are no leaks in the fuel, Traction Fluid, coolant, or piping.	
3	Make sure there is no excessive stress on any fuel lines or hoses.	
4	Make sure the installed parts do not come in contact with any other parts.	

(5)After verifying the above items, raise and keep the RPM stable at 2000RPM for 10 seconds. Immediately shut off the engine and check the Traction Fluid level. The level needs to be at level ① indicated in the diagram below. If it is lower, add Traction Fluid as necessary.

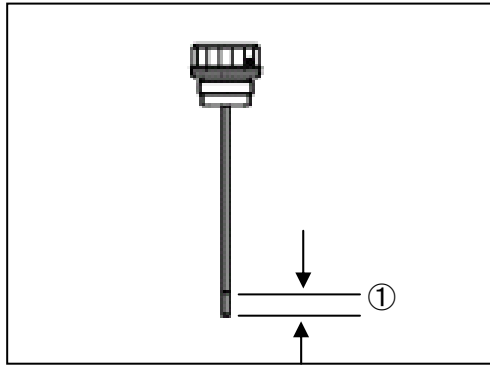

※ If there is excess Traction Fluid remaining in the bottle, replace the cap on the bottle and store in a safe location. Always store excess Traction Fluid in the original bottle.

(6)Put the oil tank cap back on.



HKS Co., Ltd.

7181 Kitayama, Fujinomiya, Shizuoka 418-0192, Japan

<http://www.hks-power.co.jp/>